

The Instruction Set of the TANGO Controller



In der Murch 15
35579 Wetzlar
Germany
Tel.: +49/6441/9116-0
www.marzhauser.com



1. Table of Contents

1.	Table of Contents	2
2.	Introduction.....	10
3.	Remarks concerning the controller initialization.....	12
4.	Instruction Syntax Description.....	12
5.	Brief Description of the TANGO Instruction Set	13
6.	Error Numbers and their possible Root Cause	23
7.	Controller Informations.....	24
7.1.	version (Read detailed Version information)	24
7.2.	det (Read detailed Configuration)	25
7.3.	detext (Read Extended detailed Configuration)	25
7.4.	readsn (Read Serial Number)	26
7.5.	ver (Read default Version Number)	26
7.6.	iver (Internal Version String for Customers).....	26
7.7.	uptime (Read Controller Up Time)	27
7.8.	temp (Read Case or Board Temperature)	28
7.9.	maxaxis (Read number of available Axes)	28
7.10.	maxcur (Read Maximum Motor Current)	28
7.11.	etspresent (Read ETS Detect State)	29
7.12.	stagesn (Read Connected Devices Serial Number)	30
7.13.	etstemp (Read the Optional Temperature Sensors)	31
7.14.	maxpos (Maximum Position)	32
7.15.	lockpos (TransportLock Position).....	32
7.16.	cmdinfo (List of Available Instructions)	33
8.	Communication Interface Settings.....	34
8.1.	baud (Baud Rate)	34
8.2.	cts (Enable/Disable RS232 Hardware Handshake)	34
8.3.	rxtimeout (Receive Timeout).....	35
9.	Communication Interface Settings for Ethernet	36
9.1.	ipaddr (Network IP Address for TANGO).....	36
9.2.	netmask (Network Netmask).....	36
9.3.	gateway (Network Default Gateway)	37
9.4.	macaddr (TANGO unique MAC Address for Ethernet)	37
9.5.	disconnect (Network Connection Disconnect and Info)	37
10.	System Instructions	38
10.1.	save (Save Parameters)	38
10.2.	restore (Restore Saved Parameters)	38
10.3.	reset (Force a Software Reset).....	39
10.4.	pa (Enable or Disable the Power Amplifiers)	40
10.5.	paswitchoff (Power Amplifier Switchoff Reason).....	41
10.6.	ipreter (Select Instruction Set)	42
11.	Operating Modes	43
11.1.	autostatus (Set Autostatus Response Behavior)	43
11.2.	autopreset (Preset for autostatus)	44
11.3.	Extended Mode.....	45
11.3.1	extmode (Switch to Extended Mode)	45
11.4.	Scan Mode	46
11.4.1	scanmode (Scan Mode to change Axis Vector Move Behavior)	47



11.4.2	scanvel (Vector Velocity for Scanmode and Dissection)	48
11.5.	ModuloMode	49
11.5.1	modulomode (Linear or Turntable Modes)	49
11.6.	External Display Mode	50
11.6.1	configdisplay (Configure External Display)	50
11.7.	Other External Devices on RS232	50
11.7.1	configwsz (Configure W&S Piezo-Z Stage)	50
11.7.2	configturret (Configure Nikon FL-Turret)	51
12.	Controller States and Error Messages	52
12.1.	statusaxis (Read State of Axis)	52
12.2.	sta (Read Detailed State of Axis)	53
12.3.	calst (Read Calibration State of Axis)	54
12.4.	calresult (Read the Result of the last Cal Instruction)	54
12.5.	corrst (Read Position Correction State)	55
12.6.	status (Read the Controller Error State)	56
12.7.	err (Read Error Number)	56
12.8.	help (Read Error Number with Description String)	57
12.9.	cmderr (Command Error List)	57
12.10.	service (Print Service Information to Terminal)	58
12.11.	pci (Is PCI Bus)	58
12.12.	isvel (Read Actual Velocities)	58
12.13.	iscur (Read Actual Motor Current)	59
13.	General Adjustments	60
13.1.	dim (Unit for Positions and Velocities)	61
13.2.	pitch (Spindle Pitch)	62
13.3.	gear (Gear Ratio)	62
13.4.	motorsteps (Motor Steps Per Revolution)	63
13.5.	accel (Acceleration)	64
13.6.	accelfunc (Acceleration Ramp Function)	65
13.7.	stopaccel (Emergency Stop Deceleration)	66
13.8.	vel (Velocity)	67
13.9.	velfac (Velocity Factor)	68
13.10.	sevel (Secure Velocity)	69
13.11.	cur (Motor Current)	70
13.12.	reduction (Motor Current Reduction Factor)	71
13.13.	curdelay (Delay for Current Reduction)	72
13.14.	ecomove (EcoMove Current Level)	72
13.15.	axis (Enable, Disable, Switch Off Axis)	73
13.16.	axisdir (Axis Direction)	74
13.17.	motortable (Motor Correction Table)	75
13.18.	usteps (Microstep Resolution)	75
13.19.	resolution (Position Number Format)	76
13.20.	backlash (Mechanical Backlash Compensation)	77
13.21.	blsmooth (Backlash Smoothing)	77
13.22.	precmode (Precision Move Mode)	78
13.23.	precdist (Precision Move Distance)	78
13.24.	lock (Select Parameters to Lock)	79
13.25.	lockaxis (Apply the Parameter Lock to Axes)	79
13.26.	lockstate (Read all internal Lock States)	80
13.27.	stout (Select Status Signal Output)	80
13.28.	noled (Force Status LED Off)	81



13.29.	updelay (Power Up Delay).....	81
13.30.	configextpwr (Configure External Power Required).....	82
14.	Limit Switch Instructions (Hardware and Software)	83
14.1.	lim (Software Limits)	84
14.2.	lim (To Save and Recall Software Limits)	85
14.3.	clim (Circular Software Limit)	86
14.4.	limctr (Enable or Disable Limit Control)	87
14.5.	nosetlimit (Do not set Limits by Cal/Rm).....	87
14.6.	limmode (Limit Monitoring Mode).....	88
14.7.	swtyp (Type of Limit Switch)	89
14.8.	swpol (Polarity of Limit Switch)	90
14.9.	swact (Enable or Disable Limit Switches)	91
14.10.	swdir (Swap Assignment of Cal and Rm Switch).....	92
14.11.	readsw (Read Status of Limit Switches).....	93
14.12.	swin (Read Limit Switch Input Level).....	94
14.13.	statuslimit (Cal / Rm / Lim Status)	95
15.	Calibration and Range Measure Instructions.....	96
15.1.	cal (Perform Calibration to lower Limit Switch)	97
15.2.	rm (Perform Range Measure to upper Limit Switch).....	98
15.3.	vrm (Virtual Range Measure).....	99
15.4.	calmode (Closed Loop and Calibration Behavior).....	100
15.5.	calrequired (Calibration Required)	103
15.6.	caltimeout (Calibration Timeout)	103
15.7.	caliboffset (Calibration Offset).....	104
15.8.	rmoffset (Range Measure Position Offset).....	104
15.9.	keeprm (Keep Range Measure Information).....	105
15.10.	caldir (Calibration Direction)	106
15.11.	calbspeed (Calibration Speed for Retraction).....	108
15.12.	calrefspeed (Reference Signal Calibration Speed).....	108
15.13.	calpos (Calibration Position read from Encoder)	109
15.14.	calposmot (Calibration Position read from Motor)	109
15.15.	calabspos (Calibration Position from Absolute Encoder).....	110
15.16.	calzeropos (Position at CAL)	110
15.17.	calvel (Calibration Velocities for CAL Instruction).....	111
15.18.	rmvel (Range Measure Velocities for RM Instruction)	112
15.19.	autopitch (Measure Pitch after CAL Instruction)	112
15.20.	refdir (Direction for Searching the Reference Switch).....	113
15.21.	posshift (Position Shift for Zero Alignment)	113
16.	Move Instructions	114
16.1.	moa (Move Absolute).....	115
16.2.	mor (Move Relative)	115
16.3.	m (Move Relative Shortcut)	116
16.4.	distance (Distance for m).....	116
16.5.	moc (Move to Center)	117
16.6.	mol (Move to LockPos)	117
16.7.	go (Go To Position).....	118
16.8.	speed (Speed Move)	119
16.9.	sp (Speed Move)	119
16.10.	moe (Move Extended)	120
16.11.	a (Abort a currently running Move or Speed).....	121
16.12.	delay (Set the Delay Time for Consecutive Moves).....	122



16.13.	pause (Set the Pause after Position Reached).....	122
16.14.	block (Block the command interpreter).....	123
16.15.	pos (Read or Set Position)	125
16.16.	posclr (Clear Position Offset).....	125
16.17.	zero (Set Internal Position to Zero).....	126
16.18.	clearpos (Set Internal Position to Zero)	126
16.19.	limmove (Endless Move between the Axis Limits).....	127
16.20.	randmove (Endless Random Move of the Axis)	128
17.	HDI Instructions (Joystick, Trackball, ERGODRIVE)	129
17.1.	Joystick Options Explained.....	130
17.2.	joy (Generally Enable/Disable HDI)	131
17.3.	joydir (Joystick Direction or Assign Joystick per axis).....	132
17.4.	configmathe (Joystick Y Axis Direction).....	132
17.5.	joywindow (Joystick Window)	133
17.6.	joyvel (Joystick Velocity).....	133
17.7.	joyspeed (Joystick Speed Presets for BPZ Device).....	134
17.8.	keymode (Joystick Key Mode).....	135
17.9.	keyspeed (Joystick Key Speed Presets).....	136
17.10.	keyfunc (HDI Key Function).....	137
17.11.	keyfunctext (HDI Key Function Text)	138
17.12.	keyfunclock (HDI Key Function Write Protection).....	138
17.13.	joycurve (Joystick Characteristic)	139
17.14.	key (Read HDI Device Key State)	140
17.15.	keyl (Read HDI Device Latched Key State).....	140
17.16.	hwfactor (Coaxial-/ERGODRIVE Transmission Factor).....	141
17.17.	hwfactorb (Alternate Coaxial-/ERGODRIVE Factor).....	141
17.18.	hwfilter (Coaxial-/ERGODRIVE Noise Filter)	141
17.19.	tbfactor (Trackball Factor)	142
17.20.	zwheel (Is Multi-function Wheel Available)	143
17.21.	zwtravel (Multi-function Wheel Travel per Revolution).....	143
17.22.	zwaxis (Multi-function Wheel Axis)	144
17.23.	zwfactor (Multi-function Wheel Factor)	144
17.24.	zwpos (Multi-function Wheel Position Counter)	144
17.25.	tvrjoy (Pulse and Direction Joystick Functionality).....	145
17.26.	tvrjoyf (Pulse and Direction Joystick Factor).....	145
17.27.	hdi (Read HDI ID).....	146
17.28.	hdimode (HDI Mode Options).....	147
17.29.	joychangeaxis (Change Joystick X and Y Axis).....	148
17.30.	joytoaxis (Freely assign Joystick Axes to Motor Axes)	148
17.31.	configaxsel (Joystick Axis Select Option)	149
18.	Joystick Function Key Assignments	150
19.	HDI Key Functions (keyfunc).....	151
19.1.	KeyFunc: Table of available Functions	152
20.	Digital and Analogue I/O	155
20.1.	digin (I/O1 Digital Inputs)	156
20.2.	digout (I/O1 Digital Outputs)	156
20.3.	diginpol (I/O1 Digital Input Polarity)	157
20.4.	digintyp (I/O1 Digital Input Type)	157
20.5.	digoutpreset (I/O1 Digital Output Presets).....	158
20.6.	edigin (Multi I/O Digital Inputs).....	159
20.7.	edigout (Multi I/O Digital Outputs).....	159



20.8. ediginpol (Multi I/O Digital Input Ploarity) 160

20.9. edigintyp (Multi I/O Digital Input Type) 160

20.10. edigoutpreset (Multi I/O Digital Output Presets) 161

20.11. edigrlly (Multi I/O Relay Option Access) 161

20.12. adigin (AUX I/O Digital Input) 162

20.13. adigintyp (AUX I/O, AUX mini Digital Input Type) 162

20.14. adiginfunc (AUX I/O, AUX mini Digital Input Function) 163

20.15. adigout (AUX I/O Digital Output) 164

20.16. adigoutpreset (AUX I/O Digital Output Preset) 164

20.17. anain (Analogue Input) 165

20.18. anaout (Analogue Output) 166

20.19. anamode (Analogue I/O Modes) 167

20.20. stoppol (Mode and Polarity of Stop Input Signal) 169

20.21. stop (Release, Force or Check Stop Condition) 170

20.22. stopl (Latched AUX I/O-caused Stop Condition) 170

20.23. shutter (Shutter Out Signal of AUX I/O) 170

20.24. flash (Defined Pulse at AUX I/O Takt Out) 171

20.25. tvr (Pulse and Direction Input Function) 172

20.26. brake (Axis Brake Function) 173

20.27. vbrake (Axis Brake Voltage) 175

20.28. brakelay (Axis Brake Hold Voltage Delay) 175

20.29. brakemode (Axis Brake when Idle) 176

20.30. brakepos (Move to Initial Motor Pole Position) 177

20.31. drop (Liquid Dispenser – Generate Drops) 178

20.32. pump (Liquid Dispenser – Manually Add Air Pressure) 179

20.33. vbus (+24V Supply Output On/Off) 180

20.34. configvbus (+24V Supply Output Preset) 180

20.35. configcanres (USB Host +5V Supply Output Preset) 181

20.36. vusb (USB Host +5V Supply Output On/Off) 181

20.37. configvusb (USB Host +5V Supply Output Preset) 181

21. Encoder Instructions 182

21.1. encmask (Encoder Mask) 182

21.2. enc (Encoder Active) 183

21.3. encperiod (Encoder Signal Period) 184

21.4. encdir (Encoder Counting Direction) 184

21.5. encsearchdir (Encoder Search Direction) 185

21.6. encvel (Encoder Auto-Ajust Velocity) 186

21.7. encrefvel (Encoder Ref.-Signal Calibration Velocity) 186

21.8. entype (Encoder Type Configuration) 187

21.9. encctl (Encoder Configured for TTL Signal) 188

21.10. encref (Use Encoder Reference Signal) 189

21.11. encnas (Use Encoder NAS Error Signal) 190

21.12. encrefstatus (Encoder REF Signal State) 190

21.13. encrefstatusl (Latched Encoder REF Signal State) 190

21.14. encnasstatus (Encoder NAS Error Signal State) 191

21.15. encerr (Encoder Error State) 191

21.16. encamp (Encoder Signal Amplitude) 192

21.17. encpos (Encoder Position) 193

21.18. configencpos (Configure Encoder Position Preset) 194

21.19. encsync (Analog Encoder Synchronization Status) 195

21.20. hwcount (Hardware Counter) 195



21.21.	clearhwcount (Clear Hardware Counter)	195
22.	MR Encoder Instructions	196
22.1.	mra (MR Amplitude Correction Factor)	196
22.2.	mro (MR Offset Correction Value)	196
22.3.	mrp (MR Signal Peak-To-Peak Measuring Result)	197
22.4.	mrt (MR Signal Level)	197
23.	Absolute Encoder Instructions.....	198
23.1.	encform (Absolute Encoder Data Format)	198
23.2.	encres (Absolute Encoder Data Resolution)	198
23.3.	abspos (Absolute Encoder RAW Position)	199
23.4.	Absolute Encoder Settings (examples)	199
24.	Closed Loop Instructions	200
24.1.	Setting Up the Closed Loop	201
24.2.	ctr (Control Enable).....	203
24.3.	ctrf (Control Factor).....	204
24.4.	ctrff (Extended Control Factor)	204
24.5.	ctrd (Control Target Window Delay).....	205
24.6.	ctrt (Control Timeout).....	205
24.7.	twi (Target Window).....	206
24.8.	ctrc (Control Call).....	206
24.9.	ctrsm (Control behavior outside Lock-in Range).....	207
24.10.	ctrs (Control Lock-in Range).....	207
24.11.	ctrstatus (Control Status).....	208
24.12.	ctrdiff (Control Position Difference).....	209
25.	Trigger Output Functionality (option)	210
25.1.	trig (Trigger).....	210
25.2.	trigm (Trigger Mode)	211
25.3.	triga (Trigger Axis)	213
25.4.	trigo (Trigger Output)	213
25.5.	trigs (Trigger Signal Length)	214
25.6.	trigd (Trigger Distance)	214
25.7.	trigcomp (Trigger Compensation)	215
25.8.	trigenc (Trigger on Encoder)	216
25.9.	trigf (Trigger Frequency)	217
25.10.	trigbdelay (Precise Trigger Delay for second output).....	218
25.11.	trigbwidth (Precise Signal Width for second output)	218
25.12.	trigbf (Precise Trigger Frequency for second output)	218
25.13.	trigcount (Trigger Counter)	219
25.14.	trigger (Force Trigger Signal)	219
25.15.	trigr (Set Trigger Range).....	220
25.16.	trigp (Trigger Position List Entry)	223
25.17.	trigc (Number of Trigger Position List Entries).....	226
25.18.	trigi (Trigger Position List Index)	226
25.19.	trigl (Trigger Level)	227
25.20.	trigsns (Trigger from SnapShot Input)	227
26.	The Second Trigger Signal Output.....	228
26.1.	Introduction	228
26.2.	Standard 1:1	229
26.3.	Precise Width.....	230
26.4.	Precise Delay.....	231
26.5.	Precise Frequency.....	232

27.	Snapshot – The Trigger Input Functionality (option)	233
27.1.	sns (Snapshot enable/disable).....	234
27.2.	snspreset (Preset for sns).....	234
27.3.	snsl (Snapshot Level / Polarity)	235
27.4.	snsf (Snapshot Filter).....	235
27.5.	snsm (Snapshot Mode).....	236
27.6.	Snapshot Mode Description and Examples	237
27.7.	snswm (Snapshot Wrap-Around Modes)	239
27.8.	snsr (Snapshot Counter)	240
27.9.	snsi (Snapshot Index)	240
27.10.	snsaxis (Snapshot Axis)	241
27.11.	snsr (Snapshot Position).....	242
27.12.	snsa (Snapshot Array).....	243
27.13.	snsamp (Snapshot Array Encoder Amplitude).....	244
27.14.	create (Create a Snapshot Array Position List)	245
27.15.	snsr (Snapshot Event)	246
27.16.	snsv (Snapshot Voltage)	246
27.17.	snsj (Snapshot Jump).....	247
27.18.	prehome (Snapshot PreHome Position)	248
27.19.	home (Snapshot Home Position).....	248
27.20.	snsr (Save Snapshot Array)	249
27.21.	dissect (Direct Dissection Start)	250
28.	Nikon FL-Turret Instructions	251
28.1.	tur (FL-Turret: Read Connection State)	251
28.2.	init (FL-Turret: Initialize the Turret)	251
28.3.	fil (FL-Turret: Select Filter).....	252
28.4.	shut (FL-Turret: Open/Close the Shutter)	252
28.5.	er (FL-Turret: Read Turret Error State).....	252
28.6.	env (FL-Turret: Enable/Disable 5V)	253
28.7.	enpower (FL-Turret: Enable/Disable 24V)	253
28.8.	auto (FL-Turret: Auto Response)	253
28.9.	cmode (FL-Turret: Continuous Mode).....	254
28.10.	res (FL-Turret: Software Reset).....	254
28.11.	nflctrver (FL-Turret: Firmware Version)	254
29.	Filter Wheel Instructions	255
29.1.	faxis (Axis for Filter Wheel).....	255
29.2.	finit (Initialize the Filter Wheel).....	255
29.3.	fcoun (Read Number of Filter Wheel Positions).....	256
29.4.	filter (Select Filter).....	256
30.	Objective Revolver Instructions (option)	257
30.1.	raxis (Axis for Märzhäuser Objective Revolver)	257
30.2.	rinit (Initialize the Objective Revolver).....	257
30.3.	rcoun (Read Number of Revolver Wheel Positions)	258
30.4.	obj (Select Objective).....	258
31.	External MW Filter Wheel Instructions	259
31.1.	tur (Read Connection State)	259
31.2.	init (Initialize the Filter Wheel).....	260
31.3.	fil (Select Filter).....	260
31.4.	shut (Open/Close the Shutter)	260
31.5.	er (Read Error State)	261
31.6.	env (Enable/Disable 5V)	261



- 31.7. enpower (Enable/Disable Motor Power)261
- 31.8. auto (Auto Response).....261
- 31.9. cmode (Continuous Mode)262
- 31.10. res (Software Reset).....262
- 31.11. nfltctrver (Firmware Version)262
- 31.12. filcorr (Filter Position Correction of external wheel)263
- 31.13. filsave (Save Filter Position Correction to Wheel)264
- 32. Piezo-Z Controller Instructions265**
- 32.1. pzcal (Piezo-Z Calibrate)266
- 32.2. pzrm (Piezo-Z Range Measure).....266
- 32.3. pzmoa (Piezo-Z Move Absolute).....267
- 32.4. pzmor (Piezo-Z Move Relative)267
- 32.5. pzpos (Piezo-Z Position).....267
- 33. Piezo-XY Stage Controller Instructions268**
- 33.1. perr (Piezo Error)268
- 34. Appendix A – anain options of different TANGOs269**
- 35. Appendix B – TANGO Controller Types (readsn)271**
- 36. Appendix C – Setup for Rotary Axes272**
- 37. Appendix D – Macros (Own Instruction Sequences).....274**
- 37.1. initxy (Initialize X and Y axis)275
- 37.2. Macro Example Code (3x3 Matrix Scan with Trigger).....276
- 37.3. Macro Example Code (Open Loop Cal Accuracy Test)277
- 37.4. Macro Example Code (Index and Timestamp)278
- 38. Appendix E – Standalone Applications280**
- 39. Appendix F – Center Reference.....281**
- 40. Appendix G – How to Distinguish TANGOs282**
- 41. Glossary283**
- 42. Document Revision History284**

2. Introduction

Communication interface:

All TANGO controllers appear as a serial COM port, independent of the controller type (RS232C, USB, PCI, PCI-E). The default setting to open any TANGO COM Port is 57600,8,2,N. Most USB and PCI TANGOs transform this to much higher baudrates.

Axes:

TANGO controllers are available with up to 4 axes. The axis specifiers used in the TANGO instruction set are the ASCII characters *x*, *y*, *z*, and *a*. Axes can be addressed individually by using the axis specifier or combined if no axis is specified in the instruction.

Instruction syntax:

The instructions and parameters are sent as ASCII strings with a terminating carriage return [CR], which is 0x0d hex. Characters should be lower case, but upper and camel-case are also accepted. The parameters are separated by a space character. This provides easy access to all functions by using a simple terminal program such as HyperTerminal. A typical instruction syntax is as follows:

```
[!,?][instruction][SP][optional axis] [parameter1][SP][parameter2] [etc...] [CR]
```

[!,?] Read/write specifier, required by most instructions **:

! (exclamation mark) = to write parameter, execute an instruction etc.

? (question mark) = to read data (returns settings, or status, etc.)

[*instruction*] Is the instruction word itself.
[*SP*] Space (ASCII 0x20 hex) as separation.
[*optional axis*] Axis character *x*, *y*, *z* or *a* if only one axis must be addressed.
[*parameter*] Usually integer or floating point numbers, floating point uses decimal point, no comma.
[*CR*] Termination (ASCII 0x0d hex), causes instruction execution.

A read instruction may return more than one parameter. In many cases the number of returned parameters depends on the amount of available axes:

```
[axis X] [if available: axis Y] [if available: axis Z] [if available: axis A]
```

For some instructions that return fractional numbers (e.g. ?pitch, ?gear, ?vel, ?encperiod and more) the number of returned fractional digits can be specified in order to increase resolution when reading back the value. For '?pos' and similar position returning functions (e.g. 'lim'), the number of fractional digits can be set by the '**resolution**' parameter. Replies are terminated by [CR].

Syntax examples:

```
!vel 10 1.5      set velocities for the first two axes
!cal            perform a calibration move to lower limit on all active axes
!moa y 10.1     move y axis to absolute position 10.1
?pos           returns position of all axes (e.g. 0.0000 0.0000 0.0000)
?vel x         returns velocity setting of X axis only (e.g. 10.000)
```

Moves:

Move instructions are executed as a vector move (except when in **ScanMode**). If several axes are started with one instruction they will reach their destinations at the same time. This means that - depending on velocity, acceleration and travel distance - one leading axis travels at its full velocity while the others follow synchronously. To move axes independently with their individual velocities, they have to be started separately by single axis instructions. Or **scanmode 3** can be set. Please refer to the '**move**' struction descriptions.

Settings:

Most settings can be stored permanently in the TANGO controller, so they are available from power on, and also reduce or eliminate initialization overhead. Refer to the '**save**' instruction for further information. Parameters that are saved can be identified by a 'Y' in the Save column of the **brief instruction set description** later in this document. Almost all settings are applied immediately with the instruction, no reboot required.

Character limits:

To prevent the input buffer from overflow, please do not send more than 255 characters at once (2nd gen. TANGOs have a larger buffer).

Such may happen when sending the setup sequence to the TANGO controller. A good practice is to request the '**?err**' state after each setup instruction. This will return the information if the parameters were accepted or not while preventing overflow.

Another solution is to activate the '**!cts**' handshake (available only with Desktop RS232C and some USB versions). This will automatically halt the PC transmission for as long as the input buffer is full. The PC COM port then must be opened with hardware handshake on, as well. Please refer to '**!cts**'.

Important: Secure speed limitation

The TANGO controllers have a built-in safety function, which reduces the maximum travel velocity to a secure 10mm/s for as long as no initial '**cal**' and '**rm**' moves have been executed. This is to prevent the axes from damage that could be caused by moving fast into its end positions. After calibrating the axis into its endswitches (cal and rm, if switches are mounted and enabled) the travel velocity is no longer limited, as the axis then can stop before the ends. If it is not wanted or impossible to perform calibration and range measure after each power on:

- A) The secure speed limit may be increased to up to 100mm/s at own risk. Please refer to the '**secvel**' instruction for further information.
- B) The '**!rm**' can be skipped by instead using '**!vrm**' (please read remarks).
- C) Nonexistent limit switches can be deactivated (by **swact**) and then do not require a '**!rm**'. In such case secvel will be released after '**!cal**'.

Important: Measuring units

The measuring unit is set by the '**dim**' instruction, where dim 9 or 2 [mm] is the default setting.

In all dim settings except of dim 9 or 10, the velocity (vel) is in motor revolutions per second. Dim 9 provides the millimeter unit for most parameters¹, positions and velocities, while dim 10 does the same for μm units (vel in dim 10 is in mm/s not $\mu\text{m/s}$, so dim 10 provides pitch- and gear-independent velocities compatible to a 1mm/rev pitch).

Extended mode:

In addition to the improvements when using dim 9 or 10, there is an option to enable "extended mode" behavior. It enables more functionality, like separate calibration, rm and joystick velocities, which else are derived from the axis velocity (vel). Please refer to the '**extmode**' instruction for further details.

Remarks:

** [!,?] Read/write specifier:

Even if not required (optional) with some instructions (e.g. moa, mor, m, go, etc.), the response in **autostatus mode 2** depends on the exclamation mark. If this special autostatus mode is required, it must be taken care of whether or not the [!] is used. Refer to **autostatus** for further information.

¹ Only **calbspeed** and **calrefspeed** are always in 1/100 revolutions/sec, even in dim 9 or 10

3. Remarks concerning the controller initialization

The TANGO controller must be configured to meet the hardware requirements. The configuration can be stored permanently with the **save** instruction. It is recommended to save and reboot the controller after changing the setup parameters (e.g. **!usteps**, **!pitch**, **!gear**) to ensure all changes will be applied.

- The axis units: **!dim**
- The **!extmode** (0 or 1)
- The axis **!pitch** (always in [mm], independent of **dim**)

Dim 9 or 10 and Extmode:

Using **dim=9** and **extmode=1** instead of **dim=2** will turn all units (also **vel** and **joyvel**) to [mm] and [mm/s]. **Extmode=1** offers bugfixes, more features (e.g. a separate **joyvel**) and flexibility. But it has a slightly different behavior. Please refer to the **Extended Mode** description in this document.

From Firmware 1.73, **dim 10** can be used to replace **dim 1** → velocities in mm/s.

4. Instruction Syntax Description

The TANGO instructions can be used for read and/or write access. The controller identifies a read instruction by a proceeding '?', while '!' indicates writing to a parameter or executing an instruction (e.g., a move).

The **Brief Description of the TANGO Instruction Set** gives a coarse overview. If the '!' or '?' is in brackets (), it means it can be skipped for either reading (?) or writing (!). If there is only a '!' or '?', it means the instruction is only for write or read access.

Many of the TANGO instructions access the axes. Therefore, either the axis can be specified, followed by the parameter or as many parameters can be provided starting from axis 1 (x) as required.

More information can be found in the **Introduction** chapter of this document.

Some examples of a legal instruction syntax:

```
!Instruction [parameterX] [parameterY] [parameterZ] [parameterA]
!Instruction [parameterX] [parameterY]
!Instruction [axis] [parameter_for_the_axis]
!Instruction [parameter]
!Instruction
?Instruction
?Instruction [axis]
```

Move Instructions and Cal/Rm:

Before starting a move, the user or application must ensure there is no move running on the involved axes or wait for a running move to complete, else the move would be discarded, not appended. The default is having **autostatus** set to 1 and wait for the "complete" auto reply (e.g. "@@@-.") or to poll the axis state at **autostatus 0** (off) with **'sa'** or **'sta'**. Another option for consecutive moves could be using the **'block'** instruction → FIFO execution from the receive buffer.



5. Brief Description of the TANGO Instruction Set

Controller Informations

Instruction	Example	Save	Example description	Page
(?) version	version	-	Read detailed firmware and controller version	24
(?) det	det	-	Read the controller configuration	25
(?) detext	detext	-	Read the controller configuration and descriptive text list	25
(?) readsn	readsn	-	Read the controller serial number	26
(?) ver	ver	-	Read default version number	26
(?!) iver	liver scanner 433	-	Set an own "iver" identification string	26
(?) uptime	uptime	-	Read how long the controller is running	27
(?) temp	temp	-	Read case temperature (avail. depends on controller type)	28
? maxaxis	?maxaxis	-	Read number of available axes	28
? maxcur	?maxcur	-	Show the maximum possible motor currents of all axes	28
? etspresent	?etspresent	-	Check availability of ETS	29
? stagesn	?stagesn	-	Read axis or stage serial numbers from all 4 ETS	30
(?) etstemp	?etstemp 0 48 49	-	Read optional temperature sensors 1 and 2 of ETS#0	31
? maxpos	?maxpos x	-	Read maximum available position range for X axis	32
? lockpos	?lockpos	-	Read the microscope stage transport lock (screw) position	32

Communication Interface Settings

Instruction	Example	Save	Example description	Page
? ! baud	!baud 115200	Y	Set RS232 baud rate (here to 115200Bd, default is 57600)	34
? ! cts	!cts 1	Y	Enable CTS hardware handshake	34
? ! rxtimeout	?rxtimeout	Y	Read the TANGO Desktop HE inter-character rx timeout	35

Communication Interface Settings for Ethernet

Instruction	Example	Save	Example description	Page
? ! ipaddr	!ipaddr 192.168.1.15	Y	Set the TANGO Desktop HE IP-address	36
? ! netmask	!netmask 255.255.255.0	Y	Set the TANGO Desktop HE netmask	36
? ! gateway	!gateway 192.168.1.254	Y	Set the TANGO Desktop HE default network gateway	37
(?) macaddr	macaddr	-	Read the TANGO Desktop HE unique MAC-48 address	37
? ! disconnect	?disconnect 1	-	Read info of the client PC connected to the Desktop HE	37

System Instructions

Instruction	Example	Save	Example description	Page
(!) save	save	-	Save parameters to controller nonvolatile memory	38
(!) restore	restore	-	Reload saved controller parameters from n.v. memory	38
(!) reset	reset	-	Reset controller (forces restart, similar to cycle power)	39
? ! pa	!pa 1	-	Power amplifiers ON (OFF=0), also refer to 'axis' instr.	40
(?) paswitchoff	paswitchoff	-	Request the reason for a pa=0 error (error 29)	41
? ! ipreter	!ipreter 2	Y	Select optional Venus instruction set	42

Operating Modes

Instruction	Example	Save	Example description	Page
? ! autostatus	!autostatus 0	-	Select autostatus response type 0 (=disabled), range: [0-4]	43
? ! autopreset	!autopreset 0	Y	Set power-up default for autostatus to 0 (=disabled)	44
? ! extmode	!extmode 1	Y	Enable extended controller behavior	45
? ! scanmode	!scanmode 1	Y	Set positioning behavior to scanmode	47
? ! scanvel	!scanvel 0.5	Y	Set scanmode vector velocity to 0.5 mm/s	48
? ! modulomode	!modulomode a 1	Y	Set positioning behavior of A axis to turntable mode 1	49
? ! configdisplay	!configdisplay 1	Y	Enable PROFILER SCD CL position display on RS232	50



Operating Modes

Instruction	Example	Save	Example description	Page
? ! configwsz	!configwsz	Y	Configure the use of W&S Piezo Z-Stage support (RS232)	50
? ! configturret	!configturret 1	Y	Configure the Nikon Turret support: see Operating Modes	51

Controller States and Error Messages

Instruction	Example	Save	Example description	Page
(?) statusaxis	statusaxis (or sa)	-	Read axis state [@,M,J, S,A,D,E,T,-]	52
(?) sta	sta	-	Read detailed axis state as 32 bit HEX number	53
(?) calst	calst z	-	Read calibration state of the Z axis	54
(?! calresult	calresult x	-	Read the result of the last cal instruction of the X axis	54
(?) corrst	corrst x	-	Read state of position correction	55
(?) status	status	-	Read controller error state	56
(?) err	err	-	Read error number	56
(?) help	help	-	Read error number with additional descriptive text	57
(?) service	service	-	Returns a detailed parameter and state list, for debugging	58
(?) pci	pci	-	Returns 1 if controller is plugged in a PCI slot (desktop=0)	58
(?) isvel	?isvel x	-	Read actual velocity of the X axis	58
(?) iscur	?iscur x	-	Read the momentarily applied motor current of the X axis	59

General Adjustments

Instruction	Example	Save	Example description	Page
? ! dim	!dim 1 1 1	Y	Set position measuring units of X Y Z to μm	61
? ! pitch	!pitch 1 1 1	Y	Set spindle pitch of X Y Z to 1 [mm/revolution]	62
? ! gear	!gear 1 1 1	Y	Set gear factor of X Y Z to 1	62
? ! motorsteps	!motorsteps x 200	Y	Set motor step type of X to 200 [steps/rev] for a 1.8° motor	63
? ! accel	!accel 0.1 0.1 0.1	Y	Set acceleration of X Y Z to 0.1m/s ²	64
? ! accelfunc	!accelfunc 1 1 0	Y	Set acceleration function X and Y to s-curve, Z to linear	65
? ! stopaccel	!stopaccel 2 2	Y	Set stop deceleration for X and Y to 2m/s ²	66
? ! vel	!vel 10 10 10	Y	Set axis velocity of X Y Z to 10	67
? ! velfac	!velfac 1 1 1	Y	Set velocity reduction factor for X Y Z to 1 (= no reduction), range is [0.01-1], use not recommended	68
? ! secvel	!secvel x 20	Y	Set secure speed limit X to 20mm/s (unit is always mm/s)	69
? ! cur	!cur 0.5 0.6 1	Y	Set motor current in Ampere: X=0.5 Y=0.6 and Z=1 A	70
? ! reduction	!reduction 0.5 0.5 0.5	Y	Set idle motor current reduction for X Y Z to 50%	71
? ! curdelay	!curdelay 1000 1000	Y	Set idle motor current reduction delay for X+Y to 1000 ms	72
? ! ecomove	!ecomove 30 30 0	Y	Set motor move eco-level of X and Y to 30% less current	72
? ! axis	!axis 1 0 -1	Y	Enable X, disable Y and switch off Z axis	73
? ! axisdir	!axisdir 0 1 0	Y	Reverse the direction of the Y axis (caution!)	74
? ! motortable	!motortable x 2	Y	Select custom motor correction table to type 2 for X axis	75
? ! usteps	!usteps 50000	Y	Set dim 0 microsteps per rev to 50000 (applies to all axes)	75
? ! resolution	!resolution 6	Y	Set position readout resolution to 1 nanometer	76
? ! backlash	!backlash 12.3 0 0	Y	Set backlash compensation to 12.3 μm in X and 0 in Y & Z	77
? ! blsmooth	!blsmooth 1 1	Y	Set backlash smoothing mode 1 for X and Y axes	77
? ! precmode	!precmode z 3	Y	Set Precision Move mode 3 for Z to eliminate backlash	78
? ! precdist	!precdist z 0.002	Y	Set the Precision Move distance in Z to 2 μm	78
? ! lock	!lock 2 1	Y	Set write protection for parameter 2 (here: motor current)	79
? ! lockaxis	!lockaxis 0 0 0 0	Y	Remove lock protection from all axes (lock has no effect)	79
? lockstate	?lockstate x	-	Read lock state of the X axis parameters	80
? ! stout	!stout 2	Y	Make Status-LED state available at AUX I/O Pin VR_OUT	80
? ! noled	!noled 1	Y	Switch Status-LED permanently off	81
? ! updelay	!updelay -5000	Y	Wait to a maximum of 5 seconds for valid external power	81
? ! configextpwr	!configextpwr 1	Y	TANGO PCI-E: Ensure external power supply is present	82

**Limit Switch Instructions (Hardware and Software)**

Instruction	Example	Save	Example description	Page	
? !	lim	!lim 0 10 0 10 0 10	-	Set lower position limit to 0 and upper limit to 10 (assume unit is [mm] if dim was set to 2) for X Y Z	84
? !	clim	!clim 50 70 10	-	Set circular limit at center X=50, Y=70 with radius 10	86
? !	limctr	!limctr x 0	Y	Disable axis limits for X axis, default = 1	87
? !	nosetlimit	!nosetlimit 1 1 1 1	Y	Disable setting/overwriting of software limits during cal and rm for all axes (here: X Y Z A), default = 0	87
? !	limmode	!limmode 1	Y	Prevent moves that exceed a position limit	88
? !	swtyp	!swtyp 1 0 1 !swtyp y 0 0 0	Y	Set limit switch type for all axes to NPN (pull-up resistor) Set limit switch type for Y to PNP (pull-down resistor)	89
? !	swpol	!swpol 1 0 1 !swpol z 1 0 1	Y	Set limit switch polarity E0, EE for all axes (to active high) Set limit switch polarity E0, EE for Z (1=to active high)	90
? !	swact	!swact 1 0 1 !swact y 1 0 0	Y	Enable cal and rm limit switches for all axes Enable cal limit switch for Y, disable ref and rm	91
? !	swdir	!swdir x 1	Y	Swap CAL and RM endswitch assignment of X axis	92
(?)	readsw	readsw	-	Read states of all limit switches (1=active and actuated)	93
(?)	swin	swin	-	Read TTL signal level of all limit switch inputs (1=high)	94
(?)	statuslimit	statuslimit	-	Read momentary limit status „A“ = calibration done „D“ = rm done „L“ = position limit(s) modified by software „“ = no limits set yet	95

Calibration and Range Measure Instructions

Instruction	Example	Save	Example description	Page	
(!)	cal	cal	-	Perform a calibration move for all enabled axes, see 'axis'	97
(!)	rm	rm x	-	Perform a range measure move in X	98
(!)	vrms	vrms 75 50	-	Virtual range measure for a 75x50 microscope stage	99
? !	calmode	!calmode 2 2	Y	Set calibration/closed loop behavior X, Y to mode 2	100
? !	calrequired	!calrequired z 1	Y	Z axis does not move until '!cal' is executed	103
? !	caltimeout	!caltimeout 60 60 10	Y	Set calibration timeout for X and Y to 1 minute, Z to 10s	103
? !	caliboffset	!caliboffset 1 1 1	Y	Set the cal zero-point 1mm aside lower limit switch (dim 2)	104
? !	rmoffset	!rmoffset 1 1 1	Y	Set rm end-position 1mm aside upper limit switch (dim 2)	104
? !	caldir	!caldir z 0	Y	Set Calibration Direction/Type of Z to default (cal→E0)	106
? !	calbspeed	!calbspeed 20	Y	Set the speed for move out of 'cal' and 'rm' limit switches for all axes to 0.2 [revolutions/s], range is [1...100]	108
? !	keeprm	!keeprm 1 1	Y	Keep the RM position for following X+Y cal instructions	105
? !	calrefspeed	!calrefspeed 10	Y	Old instruction for globally setting the encoder ref search velocity in [rev/s]. Please use encrfvel instead.	108
? !	calpos	calpos	-	Read encoder position where the cal switch was released	109
? !	calposmot	calposmot	-	Read µstep position where the cal switch was released	109
(?)	calabspos	calabspos	-	Read abs.-encoder pos. where cal switch was released	110
?	calzeropos	?calzeropos	-	Read the "zero" position after cal (for calmode 1)	110
? !	calvel	!calvel x 10 0.5	Y	Only if extmode = 1: Set calibration velocities in X	111
? !	rmvel	!rmvel x 10 0.5	Y	Only if extmode = 1: Set range measure velocities in X	112
? !	autopitch	!autopitch x 1	Y	Measure pitch after cal move of X axis	112
? !	refdir	?refdir y	Y	(dummy) Read the direction for Y-axis REF switch search	113
? !	posshift	!posshift y 438.1338	Y	Set the Center Reference shift for X to 438.1338 mm	113

Move Instructions

Instruction	Example	Save	Example description	Page	
(!)	moa	moa 10 10 10 moa y 20	-	Move X Y Z absolute to positions 10 10 10 Move Y axis to position 20 (unit depends on dim setting)	115

**Move Instructions**

Instruction	Example	Save	Example description	Page
(!) mor	mor 4 4 4 mor y -10.5	-	Move X Y Z relative by 4 (unit depends on dim setting) Move Y axis relative 10.5 backwards	115
(!) m	m	-	Move relative again (use same parameters as defined by 'distance' or the last relative move (e.g. '!mor') instruction	116
? ! distance	!distance 1 1 1	-	Set distance for X Y Z 'm'-move (start with 'm' or '!m')	116
(!) moe	moe 5 10.2 25.3	-	Move X to 10.2 and Z to 25.3	120
(!)? moc	moc x	-	Move X to center position between lower and upper limit switch, or between lower and upper software limits	117
(!) mol	mol	-	Move all axes to their transportlock positions (fix. screw)	117
(!) go	go x 12.5	-	Move X to pos. 12.5, overwritable, for tracking applications	118
! ? speed	!speed 5 5 5 !speed y 0	-	Let X Y Z axis travel at 5 [rev/s, or mm/s at dim 9+10] Stop a running 'speed' or 'go' instruction on the Y axis	119
(!)? sp	sp 5 5 5	-	Let X Y Z axis travel at 5 [rev/s, or mm/s at dim 9+10] Same as speed, but without the need of active joydir	119
(!) a	a	-	Abort move (Stop)	121
? ! delay	!delay 1000	Y	Delay the start of move instructions by 1000 ms	122
? ! pause	!pause 10	Y	Delay "position reached" autostatus response by 10 ms	122
(!) block	block	-	Blocks the command interpreter until all axes are idle	123
? ! pos	!pos 0 0 1.5 ?pos z	-	Set current X Y positions to 0 and Z position to 1.5 Read current Z position	125
(!) posclr	!posclr x	-	Reset the position offset that was caused by setting "!pos"	125
(!) zero	!zero z	-	Set Z position and internal counter to 0 (e.g. filter wheel application)	126
(!) clearpos	!clearpos z	-	Set Z position and internal counter to 0 (e.g. filter wheel application), not executable with measuring system	126
! ? limmove	!limmove z 1	-	Start endless move of the Z-axis within the full travel range	127
! ? randmove	!randmove z 1	-	Start endless random move of the Z-axis	128

HDI Instructions (Joystick, Trackball, ERGODRIVE)

Instruction	Example	Save	Example description	Page
? ! joy	!joy 2 !joy 0	Y	Switch joystick ON=2 or OFF**=0 (*Switching off may cause an @@@ autostatus response)	131
? ! joydir	!joydir 2 -2 0	Y	Set HDI axis mode to X=ON, Y=Reversed, Z=OFF	132
? ! configmathe	!configmathe 0	Y	Set the joystick Y-axis direction to default (=reversed)	132
? ! joywindow	!joywindow 14	Y	Set idle window of the joystick center position, where an analog joystick deflection has no effect [0..100]	132
? ! joyvel	!joyvel z 1.5	Y	Only if extmode = 1: Set joystick velocity for Z to 1.5	133
?(!) joyspeed	joyspeed 2 25	Y	Set joystick speed for speed button 2 "medium" to 25 rev/s	134
? ! keymode	!keymode 2	Y	Select joystick key mode 2 = high speed preselection	135
? ! keyspeed	!keyspeed x 5 20	Y	Set keymode joystick speed X low=5mm/s, high=20mm/s	136
? ! keyfunc	!keyfunc 3 4 7	Y	Assign function 4 to HDI key F3, address axes XYZ (=7)	137
? ! keyfunctext	!keyfunctext ?pos#	Y	Define a TANGO command text for keyfunc 70	138
? ! keyfunclck	!keyfunclck 1	Y	Lock the keyfunc and keyfunctext settings: write protect on	138
?(!) joycurve	!joycurve z 1	Y	Set joystick characteristic for Z to linear	139
(?) key	key	-	Read state of all joystick buttons (0=released, 1=pressed)	140
(?) keyl	keyl	-	Read and clear latched state of all joystick buttons	140
? ! hwfactor	!hwfactor x 1	Y	One coaxial drive knob revolution in X is 1mm axis travel	141
? ! hwfactorb	!hwfactorb x 14	Y	One coaxial drive knob revolution in X is 14mm axis travel	141
? ! hwfilter	!hwfilter 0	Y	Deactivate coaxial drive noise reduction	141
? ! tbfactor	!tbfactor 1 1	Y	Set trackball transmission factor in X and Y to default	142
(?) zwheel	?zwheel	-	Returns 1 if HDI device has a multi-function wheel	143
?(!) zwtravel	!zwtravel 1 0.25	Y	Set default multi-function wheel travel to 2.5 mm/rev	143
? ! zwaxis	!zwaxis a	Y	Assign multi-function wheel to A-axis	144



HDI Instructions (Joystick, Trackball, ERGODRIVE)

Instruction	Example	Save	Example description	Page	
? !	zwfactor	!zwfactor 1	Y	Set multi-function wheel factor to 1:1 (default)	144
(?)!	zwpos	zwpos	-	Read independent multi-function wheel position counter	144
? !	tvrjoy	!tvrjoy z	Y	Assign AUX I/O pulse+direction device to Z axis	145
? !	tvrjoyf	!tvrjoyf 1	Y	Set tvrjoy transmission factor to 1	145
(?)	hdi	hdi	-	Read ID number of the connected HDI device	146
! ?	hdimode	!hdimode 0 1	Y	Set hdimode bit 0 to 1 for ERGODRIVE Toggle Mode	147
! ?	joychangeaxis	!joychangeaxis 1	Y	Change Joystick X and Y axis (X↔Y)	148
! ?	Joytoaxis	!joytoaxis 1 1 2	Y	Assign Joystick axis 1 (X) to X+Y, and axis 2 (Y) to Z	148
! ?	configaxsel	!configaxsel 1	Y	Toggle Joystick Z-axis between axes Z and A by F4 key	149

Digital and Analogue I/O

Instruction	Example	Save	Example description	Page	
(?)	digin	digin digin 8	-	I/O1 Extension module: Read all digital inputs I/O1 Extension module: Read digital input 8	156
? !	digout	!digout 5 1 ?digout	-	I/O1 Extension module: Set digital output 5 to logic level 1 I/O1 Extension module: Read back all digital output levels	156
? !	diginpol	!diginpol 5 1	Y	I/O1 Extension module: Invert input 5 signal	157
? !	digintyp	!digintyp 111111	Y	I/O1 Extension module: Apply pull-up resistor to all inputs	157
? !	digoutpreset	!digoutpreset 3 1	Y	I/O1 Extension module: Preset state of output 3 to high	158
(?)	edigin	edigin edigin 8	-	Multi I/O Extension: Read all digital inputs Multi I/O Extension: Read digital input 8	159
? !	edigout	!edigout 5 1 ?edigout	-	Multi I/O Extension: Set digital output 5 to logic level 1 Multi I/O Extension: Read back all digital output levels	159
? !	ediginpol	!ediginpol 5 1	Y	Multi I/O Extension: Invert input 5 signal	160
? !	edigintyp	!edigintyp 111111	Y	Multi I/O Extension: Apply pull-up resistor to input 0-5	160
? !	edigoutpreset	!edigoutpreset 3 1	Y	Multi I/O Extension: Preset state of output 3 to high	161
? !	edigrly	!edigrly 1	-	Multi I/O Extension: Switch optional relay on	161
(?)	anain v 51	anain v 51	-	I/O1 or Multi I/O supply voltage	165
(?)	adigin	adigin adigin 2	-	Read all AUX I/O digital inputs Read logic level of AUX I/O digital input 2 only	162
! ?	adigintyp	!adigintyp 1111		Apply pull-up resistors to the first 4 adigin inputs	162
! ?	adiginfunc	!adiginfunc 2 0 0 1		Select adigin 0 as snapshot and adigin 3 as stop input	163
? !	adigout	!adigout 3 1	-	Set AUX I/O digital output 3 to high (+5V)	164
? !	adigoutpreset	!adigoutpreset 3 1	Y	TANGO Desktop HE: Set AUX I/O digital output defaults	164
(?)	anain	anain c 10	-	Read input of analogue channel 10 (the analog input)	165
? !	anaout	!anaout c 1 17.5	-	Set analogue output voltage of channel 1 to 17.5 percent	166
? !	anamode	!anamode 0	(Y)	Set analogue output mode to default behavior	167
? !	stoppol	!stoppol 1	Y	Set AUX I/O stop input to active high	169
? !	stop	!stop 0	-	Release stop condition (in latched stoppol modes only)	170
? !	stopl	?stopl	-	Check if an AUX I/O stop condition was present	170
? !	shutter	!shutter 1	-	Set AUX I/O shutter out signal to TTL high	170
(!)	flash	flash 0.1	-	Send a 100µs high pulse to AUX I/O TAKT_OUT (LED)	171
? !	tvr	!tvr z 5	Y	Enable AUX I/O TVR pulse+direction function for Z axis	172
? !	brake	!brake 0 0 1	Y	Enable Brake for Z axis on I/O extension output pin OUT0	173
? !	vbrake	!vbrake 24 14	Y	TANGO Desktop HE: Set brake open and hold voltages	175
? !	brakedelay	!brakedelay 50	Y	TANGO Desktop HE: Set open to hold voltage delay [ms]	175
? !	brakemode	!brakemode 1	Y	Enable brake mode to activate brake when axis is idle	176
(!)	brakepos	brakepos z	-	Move to initial motorpole position to avoid power-up "jump"	177
? !	drop	!drop 5	-	Liquid Dispenser: generate 5 drops or dispense for 5 sec.	178
? !	pump	!pump 1	-	Liquid Dispenser: Switch on air pressure pump manually	179
? !	vbus	?vbus	-	Read on/off state of the +24V supply output	180
? !	configvbus	!configvbus 1	Y	Set +24V supply output to always on	180

**Digital and Analogue I/O**

Instruction	Example	Save	Example description	Page	
? !	vusb	!vusb1	-	TANGO Desktop HE: Switch on USB-A connector +5V	181
? !	configvusb	!configvusb 1	Y	TANGO Desktop HE: Set USB-A +5V to always on	181
? !	configcanres	!configcanres 1	Y	TANGO Desktop HE: Activate CAN Bus 120Ω termination	181

Encoder Instructions

Instruction	Example	Save	Example description	Page	
? !	encmask	!encmask 1 1 0	Y	Enable the activation of X and Y encoders, disable Z	182
? !	enc	!enc 1 0	-	Manually activate X encoder (caution!), set Y to inactive	183
? !	encperiod	!encperiod 0.1	Y	Set signal period of X encoder to 100 μm	184
? !	enctype	!enctype x 1	Y	Set encoder type of X to TTL (no analogue sin/cos signal)	187
? !	encttl	!encttl x 1	Y	Set encoder type of X to TTL (no analogue sin/cos signal)	188
? !	encdir	!encdir y 1	(Y)	Reverse counting direction for Y encoder (caution!)	184
? !	encsearchdir	!encsearchdir z 1	Y	Reverse the clamode 1+2 wiggle direction for Z	185
? !	encvel	!encvel x 0.5	Y	Set auto-adjust velocity of X encoder to 0.5mm/s	186
? !	encrefvel	!encrefvel x 5	Y	Set encoder ref search velocity in X to 5	186
? !	encref	!encref 1 1 0	Y	Enable encoder reference signal for X and Y, disable for Z	189
? !	encnas	!encnas 1 0 0	Y	Enable NAS error signal input encoding for X encoder only	190
(?)	encrefstatus	encrefstatus x	-	Read X encoder reference signal state (1=on reference)	190
(?)	encrefstatusl	encrefstatusl x	-	Read latched X encoder reference signal state	190
(?)	encnasstatus	encnasstatus x	-	Read X encoder NAS signal state (1=NAS error)	191
? !	encerr	!encerr 0	-	Clear encoder error state for X axis (? response is 0 or e)	191
? !	encamp	?encamp x	-	Read X encoder signal amplitude in percent	192
? !	encpos	!encpos 1	-	?pos instruction returns for the encoder positions, if enc=1	193
? !	configencpos	!configencpos 0 0 1	Y	Preset value for encpos at power up (default=0)	194
(?)	encsync	encsync -1	-	Read the state of the encoder signal synchronization	195
(?)	hwcount	hwcount	-	Read all encoder positions (TTL counter, non-interpolated)	195
(!)	clearhwcount	clearhwcount x	-	Set hwcount encoder position counter to zero, here: X axis	195

MR Encoder Instructions

Instruction	Example	Save	Example description	Page	
? !	mra	?mra x	-	Read amplitude correction factor (sin/cos ratio) of X	196
? !	mro	?mro	-	Read offset correction value for all encoders	196
? !	mrp	!mrp x 0 0 0 0	-	Reset MR-signal peak-to-peak measurement result of X	197
?	mrt	?mrt z 2	-	List two measurement results of the Z encoder sin cos	197

Absolute Encoder Instructions

Instruction	Example	Save	Example description	Page	
? !	encform	!encform 24 24	Y	Set the absolute data word size in X+Y to 24 bit	198
? !	encres	!encres y 78.125	Y	Set the absolute data resolution in X to 78.125 nm	198
(?)	abspos	abspos	-	Read abs.-encoder pos. at the current position	199
(?)	calabspos	calabspos	-	Read abs.-encoder pos. where cal switch was released	110
? !	posshift	!posshift y 438.1338	Y	Set the absolute zero alignment for X to 438.1338 mm	113

Closed Loop Instructions

Instruction	Example	Save	Example description	Page	
? !	ctr	!ctr 2 2 2	Y	Set closed loop mode of X Y Z to always active (=default)	203
? !	ctrf	!ctrf 2.0	Y	Closed loop factors for X axis are set to 2.0 (old)	204
? !	ctrff	!ctrff 2 3.5	Y	Closed loop factors for X axis are set to 2 and 3.5	204
? !	ctrd	!ctrd 100	Y	Closed loop in target window for 100 milliseconds	205
? !	ctrtr	!ctrtr 200	Y	Closed loop control timeout after 200 milliseconds	205
? !	twi	!twi 0.01 0.01 0.01	Y	Set target window for X Y Z to 10μm (assume dim=2)	206

**Closed Loop Instructions**

Instruction	Example	Save	Example description	Page
? ! ctrc	!ctrc 3	Y	Closed loop control is called every 3 milliseconds	206
? ! ctrsm	!ctrsm x 1	Y	Set X behavior outside lock-in range to "slow closed loop"	207
? ! ctrs	!ctrs x 0.2	Y	Set lock-in range for X to 0.2mm (assume dim=2)	207
? ctrstatus	?ctrstatus 1	-	Get Closed Loop active state of all axes	208
? ctrdiff	?ctrdiff	-	Get Closed Loop position difference of all axes	209

**Trigger Output Functionality¹**

Instruction	Example	Save	Example description	Page	
? !	trig	!trig 1	-	Enable trigger functionality (the setup must be complete)	210
? !	trigm	!trigm 0	Y	Select trigger mode 0	211
? !	triga	!triga x	Y	Trigger function is related to X axis	213
! ?	trigo	!trigo 1	Y	Select the default trigger signal output	213
? !	trigs	!trigs 40	Y	Set trigger output signal length to 40 microseconds	214
? !	trigd	!trigd 10	Y	Set trigger distance to 10 (mm if dim=2)	214
? !	trigcomp	!trigcomp 50	Y	Compensate a trigger signal delay of 50µs	215
? !	trigenc	!trigenc 1	Y	Select encoder signal as trigger source (if available)	216
? !	trigf	!trigf 1000	Y	Set periodic trigger pulse frequency to 1kHz	217
? !	trigbdelay	!trigbdelay 15.05	Y	Set Precise secondary trigger out to 15.05µs delayed	218
? !	trigbwidth	!trigbwidth 4.35	Y	Set Precise secondary trigger out signal length to 4.35µs	218
? !	trigbf	!trigbf 66000000	Y	Set Precise secondary trigger out frequency to 66 MHz	218
? !	trigcount	?trigcount	-	Read number of generated trigger events	219
(!)	trigger	trigger	-	Manually set trigger output (available in trigm 102, 103)	219
? !	trigr	!trigr 5 10 6	-	Generate 6 trigger signals from 5 to 10→5,6,7,8,9,10 (mm)	220
? !	trigp	!trigp -1 12.5	-	Append a position value to the trigger position list	223
? !	trigc	?trigc	-	Read number of entries in trigp trigger position list	226
? !	trigi	?trigi	-	Read or manipulate the momentary list index of trigp, trigr	226
? !	trigl	!trigl 1	Y	Set trigger signal level for !trigr and !trigp to active high	227
? !	trigsns	!trigsns 1	Y	Enable trigger generation on snapshot events	227

Snapshot - Trigger Input Functionality¹

Instruction	Example	Save	Example description	Page	
? !	sns	!sns 1	**	Enable snapshot functionality (Before firmware 1.73 always 1 after power up, now 0 by default, see snspreset)	234
? !	snspreset	!snspreset 0	Y	** Set power-up default for sns to 0 (disabled)	234
? !	snsi	!snsi 0	Y	Set snapshot input signal to active low	235
? !	snsf	!snsf 10	Y	Set snapshot signal debounce filter to 10 milliseconds	235
? !	snsn	!snsn 0	Y	Set snapshot mode to 0 (0=capture pos, 1=move to pos)	236
? !	snsnm	!snsnm 3	Y	Set snapshot capture to wrap-around (ringbuffer) mode	239
? !	snsnc	?snsnc	(Y)	Read number of snapshot events (=array fill size)	240
? !	snsni	!snsni 5	-	Set snapshot index to 6 th entry (snsa 6)	240
? !	snsaxis	!snsaxis 1 1 0 0	-	X and Y axis moves wait for snapshot (in snsn mode 6)	241
? !	snspx	?snspx x	-	Read last captured X position	242
? !	snsa	?snsa 1	(Y)	Read first position entry of snapshot array (all axes)	243
(?)	snsamp	?snsamp -2	-	Read all encoder amplitudes of the entire snapshot array	244
(!)	create	create c 0.05	-	Create a snapshot array position list for a 50µm dia. circle	245
(!)	snsf2	snsf2 2	-	Generate SnapShot event F2	245
? !	snsv	?snsv 3	-	Read captured ANIN0 voltage in mV of 3 rd snapshot entry	246
? !	snsj	!snsj 1 0.5 0 0	(Y)	Set snapshot jump distances (snapshot mode snsn 9)	247
? !	prehome	!prehome 10 20 1	(Y)	Set prehome positions X Y Z to 10 20 1 (unit depends on dim setting)	248
? !	home	!home 5 5 0	(Y)	Set home positions X Y Z to 5 5 0 (unit depends on dim setting)	248
(!)?	snsstave	snsstave	-	Permanently store the snapshot position array	249
(!)?	dissect	dissect	-	Start a continuous path move along the snsa positions	250

¹ Function has to be enabled by factory; it is not available per default.

**Nikon FL-Turret**

Instruction	Example	Save	Example description	Page	
! ?	configturret	!configturret 1	Y	Configure the Nikon Turret support: see Operating Modes	51
?	tur	?tur	-	Read the FL-Turret connection state (1=connected)	251
! ?	init	!init	-	Initialize the FL-Turret	251
! ?	fil	!fil 1	-	Select filter number 1	252
! ?	shut	!shut 0	-	Open the FL-Turret shutter	252
! ?	er	?er	-	Read the FL-Turret error state	252
! ?	auto	!auto 1	-	Set the FL-Turret autostatus to 1 (on)	253
! ?	cmode	!cmode 1	-	Set the FL-Turret continuous mode to 1 (on)	254
! ?	env	!env 1	-	Enable the 5V	253
! ?	enpower	!enpower 1	-	Enable the 24V	253
!	res	!res	-	Reset the FL-Turret and Turret Controller	254
?	nfltctrver	?nfltctrver	-	Read the FL-Turret controller firmware version	254

Filter Wheel

Instruction	Example	Save	Example description	Page	
! ?	faxis	!faxis a	Y	Specify the A-axis for the MW Filter Wheel instructions	255
(!)?	finit	finit	-	Initialize the MW Filter Wheel (cal for the wheel)	255
(?)	fcount	fcount	-	Read the amount of filter positions (e.g. 6 → filter 1...6)	256
(!)?	filter	filter 1	-	Select filter number 1 (go to 1 st filter)	256

Objective Revolver

Instruction	Example	Save	Example description	Page	
! ?	raxis	!raxis a	Y	Specify the A-axis for the MW Objective Revolver	257
(!)?	rinit	rinit	-	Initialize the MW Objective Revolver (cal for the revolver)	257
(?)	rcount	rcount	-	Read the amount of revolver positions (e.g. 3 → obj 1...3)	258
(!)?	obj	obj 1	-	Select objective number 1 (go to 1 st objective)	258

External Filter Wheel

Instruction	Example	Save	Example description	Page	
! ?	configturret	!configturret 1	Y	Configure the ext. Wheel support: see Operating Modes	51
?	tur	?tur	-	Read the Filter Wheel connection state (1=connected)	259
(!)?	init	init	-	Initialize the MW Filter Wheel (cal for the wheel)	260
(!)?	fil	fil 1	-	Select filter number 1 (go to 1 st filter)	260
! ?	er	?er	-	Read the Filter Wheel error state	261
! ?	auto	!auto 1	-	Set the Filter Wheel autostatus to 1 (on)	261
! ?	enpower	!enpower 1	-	Enable the MotorAmplifier	261
(!)	res	!res	-	Reset the Filter Wheel Controller	262
(?)	nfltctrver	?nfltctrver	-	Read the Filter Wheel Controller firmware version	262
(!)?	filcorr	!filcorr 3 -0.0014	Y	Apply a position correction to filter 3	263
(!)	filsave	filsave	-	Store the filter correction in the Wheel	264

Piezo-Z Controller

Instruction	Example	Save	Example description	Page	
? !	configwsz	!configwsz	Y	Configure the use of W&S Piezo Z-Stage support (RS232)	50
(!)	pzcal	pzcal	-	Calibrate the Piezo-Z axis	266
(!)	pzrm	pzrm	-	Range Measure the Piezo-Z axis	266
(!)	pzmoa	pzmoa 125	-	Move to absolute position (here: 125 nm)	267
(!)	pzmor	pzmor -55	-	Move a distance (here -55 nm)	267
(?)	pzpos	pzpos	-	Read out the position (measuring system position in nm)	267

**Macro Instructions**

Instruction	Example	Save	Example description	Page
(!) initxy	initxy 1	-	Start the macro that executes cal, rm and moc on X+Y	275

For Macro Instructions, please refer to the separate TANGO Macro Functions document or check the short introduction in **chapter 37: Appendix D – Macros (Own Instruction Sequences)**.

6. Error Numbers and their possible Root Cause

0	no error
1	no valid axis name
2	no executable instruction
3	too many characters in command line
4	invalid instruction
5	number is not inside allowed range
6	wrong number of parameters
7	! or ? is missing or not allowed
8	no TVR possible, while axis active
9	no ON or OFF of axis possible, while TVR active
10	function not configured
11	no move instruction possible, while joystick enabled
12	limit switch actuated
13	function not executable, because encoder detected
14	error during calibration (limit switch not released)
15	error during calibration (opposing limit switch actuated)
21	multiple axis moves are forbidden (e.g. during initialization)
22	automatic or manual move is not allowed (e.g. door open or initialization)
27	emergency STOP is active
29	servo amplifiers are disabled (switched OFF)
30	safety circuit out of order
32	move discarded target outside limit
70	wrong CPLD data
71	ETS error
72	parameter is write protected (check lock bits)
73	internal error, e.g. eeprom data corruption
74	closed loop switched off due to parameter change, deviation or enc. error
75	could not enable axis correction, or axis correction was disabled
76	io extension error (output overload on IO1 or Multi-IO connector)
77	io/xPos internal bus communication error
78	HDI input device error
79	xPos module error
80	internal error: HDI ISR not running (2 nd gen. TANGOs: internal DMA error)
81	internal error: Encoder ISR not running
82	overload on motor connector +5V (PCI-E/DT-E: also on +5V of AUX I/O)
83	overload on AUX I/O +5V supply
84	overload on encoder +5V supply
85	overload on AUX I/O +12V supply or AUX mini +24V supply
86	low brake output voltage
87	overload on motor 4 connector +5V
88	overload on a supply output pin (latched overload state), clear by "!err"
89	not executable while in standby mode
90	temperature error
91	encoder error
92	overload on HDI +5V supply
93	overload on CAN 24V supply

Remarks: Error numbers beginning from 100 belong to special devices and the description can be found in the corresponding documentation.

7. Controller Informations

The firmware version may be read by sending the instruction '**version**' to the controller. The instruction '**det**' gives further details of which options and features are enabled. Each controller has its own unique serial number readable with the instruction '**readsn**'. The SN also contains information about the TANGO.

7.1. version (Read detailed Version information)

Syntax: `?version` or `version`

Parameter: `none`, `1` or `2`

Description: Read the TANGO type and firmware version.

Without parameter, the instruction returns the firmware string.

With parameter, the instruction returns:

1: Sending "version 1" returns the TANGO firmware version number only.

2: From TANGO firmware 1.73, sending "version 2" returns the type no. and firmware version of a handling system firmware, which is independent from the controller firmware base. Regular TANGO controllers return 0.00.

Remarks: An exception is the TANGO 3 mini, where "version 2" returns the co-processor firmware version.

Remarks: **readsn** can also be used to identify the TANGO controller type.

Response syntax: Character string including controller type, firmware version and build date separated by a comma, e.g.

TANGO-DT-S, Version 1.57, Apr 17 2012 , 12:12:02

Explanation:

TANGO-DT	Desktop version, PCI card based	
TANGO-DT-S	Desktop version, PCI-S card based	
TANGO-DTe	Desktop version, PCI-E card based	
TANGO-PCI	PCI card	
TANGO-PCI-S	PCI-S card	
TANGO-PCIE	PCI-E card (PCI Express)	
TANGO-MINI	TANGO mini	
TANGO-C	Motorized stage with integrated controller	
TANGO-I	TANGO integrale	
TANGO-MINI3	TANGO 3 mini	
TANGO-Desktop	TANGO Desktop HE	2 nd generation DTe
TANGO-I2	TANGO integrale	2 nd generation
TANGO-3-mini	TANGO 3 mini	2 nd generation
TANGO-PCIE21	PCI-E card (PCI Express)	2 nd generation
Version 1.57	Firmware version number	
Apr 17 2012	Firmware build date	
12:12:02	Firmware build time	

Example:

`?version ==> TANGO-DTe, Version 1.69, Mar 6 2018 , 15:52:19`

`?version 1 ==> 1.69 (Read the TANGO Firmware version only)`

`?version 2 ==> 1.10 (TANGO 3 mini only: Co-Processor Firmware version 1.10)`

`?version 2 ==> 0.00 (System Firmware of Regular TANGOs is 0.00)`

`?version 2 ==> 1.01 (System Firmware is Type 1 (SlideExpress), Version 01)`

7.2. det (Read detailed Configuration)

Syntax: ?det or det
Parameter: none

Description: Read detailed information of the controller configuration.

Response: The response is a decimal integer number. Its bit pattern represents the configuration as described below:

0x0 0 0 0 0 1	Encoder interface only for 1Vpp or TTL
0x0 0 0 0 0 2	Encoder interface only for MR or TTL
0x0 0 0 0 0 4	Encoder interface for TTL (or not configured)
0x0 0 0 0 0 8	Encoder interface Universal for 1Vpp, MR, TTL
0x0 0 0 0 3 0	The number of configured axes (0 to 4, here 3)
0x0 0 0 1 0 0	Display is configured (PROFILER SCD CL @RS232)
0x0 0 0 2 0 0	Speedpoti is configured
0x0 0 0 4 0 0	Hand wheel is configured
0x0 0 0 8 0 0	Snapshot (Trigger in) is configured
0x0 0 1 0 0 0	TVRin is configured
0x0 0 2 0 0 0	Trigger out is configured
0x0 0 8 0 0 0	TVRout is configured
0x0 1 0 0 0 0	Digital extension: I/O1 (24in+8out)
0x0 2 0 0 0 0	Digital extension: Multi I/O (12in+8out)
0x0 4 0 0 0 0	Trackball is configured
0x0 8 0 0 0 0	ETS is connected
0x1 0 0 0 0 0	xPos Module (3 axis extension)
0x2 0 0 0 0 0	Encoder interface Absolute for BiSS-C and SSI

Individual configured options can be identified by applying a logic AND mask to the returned value.

E.g. (val & 0x0800) to identify if Snapshot instructions are available/configured by factory, (val & 0x02000) for Trigger.

Example: Assume the ?det response is 81697, which is 0x13F21 hex. This number means in detail, that the controller is configured for:

```
1 => Built in digital I/O extension with 24in + 8out
3 => TVRin and Trigger out
F => Display, Speedpoti, Hand wheel and Snapshot
2 => 2 axes
1 => 1Vpp encoder
```

7.3. detext (Read Extended detailed Configuration)

Syntax: ?detext or detext
Parameter: none

Description: Reads the detailed information of the controller configuration like 'det', but here as a multi-line description text. Each line is terminated by a [CR].

Response: Multi line reply, containing the configuration number as hex value (bit representation as described with 'det'), followed by the meaning of it as multi line text.

Example: detext => 02832
= MR Encoder
= 3 Axes
= Snapshot
= Trigger out



7.4. readsn (Read Serial Number)

Syntax: ?readsn or readsn
Parameter: none

Description: Reads the serial number of the TANGO controller.

Response: Read the unique controller serial number as an ASCII string. It also contains the TANGO type. The syntax is YYWWTNXXX:

YY year of manufacturing
WW week of manufacturing
T controller type identifier 0-9, A-Z (refer to **Appendix B**)
N in hardware available axes (may differ from ?maxaxis)
XXX index number

Example: ?readsn => 2112**A**3002 (reply of a controller type **A**)

7.5. ver (Read default Version Number)

Syntax: ?ver or ver
Parameter: none

Description: Read the default controller version info. The first digit is the number of configured axes. The second digit is the maximum possible motor current in ampere. To read the TANGO firmware version, please use 'version'.

Response syntax: Vers:LSnm.xx.xxx (single axis Z-controllers as **ES**nm.xx.xxx)

"Vers:LS" Fixed character string (also "Vers:ES" possible)
n Number of configured axes: 1, 2, 3, or 4
m Maximum Motor current: 1=1.25A, 2=2.5A, 3=3.75A
x Fixed numbers

Example: ?ver => Vers:LS32.00.038 (=3 axis 2.5 A)

7.6. iver (Internal Version String for Customers)

Syntax: ?iver or iver (!iver option from Firmware 1.74)
Parameter: none

Description: From TANGO Firmware 1.74, 'iver' can be used to store an own application string, e.g. to identify the application or TANGO. Up to 14 characters are possible and are truncated without notice. The text may include spaces and special characters such as e.g. &,%,\$,#/,!,~,=.

Remarks: Former Firmware Versions only allowed reading of iver, which returned "-----" and for compatibility could hold a T[DD].[WW].[YY]-[NNNN] Day of Week, Week, Year, Number info. The TANGO converts all characters to lower case.

Response syntax: Up to 14 characters

Example: ?iver => ----- (reading the default string)
!iver SCANNER 433 (setting an own ASCII string)
?iver => scanner 433 (reading the ASCII string)
iver => scanner 433 (same as ?iver)

7.7. uptime (Read Controller Up Time)

Syntax: ?uptime or uptime, !uptime
Parameter: none, 1 or -2, or uptime millisecond offset as integer

Description: Returns the power-on time of the controller since it was switched on or resetted. Depending on the parameter, the readout can be in seconds, in hh,mm,ss or in milliseconds:
Parameter:
none = seconds since switched on or reset
1 = milliseconds since switched on or reset
-2 = hours, minutes, and seconds since switched on or reset
-3 = days, hours, minutes, and seconds total operating time*

The milliseconds can be manipulated.
It is possible to to set the milliseconds to zero or a specified positive value.
A negative value will clear the milliseconds offset and return to the true internal time.
The seconds and hh, mm, ss readout are not affected by the millisecond manipulation. They always return the true uptime.

Remarks: * 2nd gen. TANGO controllers support parameter 3, which returns the total operating hours of the controller as days, hours, minutes and seconds.

Response: Time in seconds
 or in milliseconds with optional time offset
 or in hours, minutes and seconds
 Please refer to the examples below.

Example: ?uptime > 4503 (run time in seconds)
 uptime > 4503 (same as ?uptime)

 uptime -2 => 01h 15m 03s (run time in hh,mm,ss)

 uptime -3 => 7d 05h 15m 21s (total time, 2nd generation TANGOs)

 uptime 1 => 45033821 (time in milliseconds)

 !uptime (sets the milliseconds uptime time to 0)
 ?uptime 1 => 2 (a following read e.g. returns 2ms)
 !uptime 1000 (sets the ms uptime time to 1000ms)
 ?uptime 1 => 1002 (a following read e.g. returns 1002ms)
 !uptime -1 (clear/remove the millisecond offset)
 ?uptime 1 => 45033826 (now uptime is back to the original)

7.8. temp (Read Case or Board Temperature)

Syntax: ?temp or temp
Parameter: none (or 1, 2 or 3)

Description: Read the controller temperature.
Remarks: Not all TANGOs provide a temperature sensor, 2nd generation controllers provide two (board/ambient and CPU).

Response: Temperature in [°C] with one decimal place.

Example: temp => 28.5
temp 1 => 43.8 (2nd gen. TANGOs only: CPU temperature)
temp 2 => 28.5 43.8 (2nd gen. TANGOs only: Ambient + CPU)
temp 3 => 51.7 75.3 (2nd gen. TANGOs only: Max since power on)

7.9. maxaxis (Read number of available Axes)

Syntax: ?maxaxis
Parameter: none

Description: Read the number of available (factory configured) axes. 1, 2, 3 or 4 (single axis Z controllers return a 'z').

Response: Number of available axes, 1 to 4 or lower case z.

Example: ?maxaxis => 3 (reply of a 3-axis controller X,Y,Z)
?maxaxis => z (reply of a single axis Z controller)

7.10. maxcur (Read Maximum Motor Current)

Syntax: ?maxcur
Parameter: x, y, z, a or none
Optional parameter 1

Description: Read the maximum possible motor current (amplifier capability) and the maximum current which can be set by **!cur**. The maximum possible current depends on the capability of the motor amplifier (e.g. 1.00/1.25/2.50/3.75A) and a factory-set limitation to protect the motor from overcurrent.

No parameter: Maximum current the power amplifier can deliver.
Parameter 1: Maximum possible Motor current, including additional limitation (by ETS factory entry).

Response: maximum motor current(s) in Ampere [A] (e.g. "1.25" or "1.00")

Examples:
?maxcur read maximum amplifier current of all available axes
?maxcur y read maximum amplifier motor current of Y axis only
?maxcur y 1 read maximum motor current of Y axis only
?maxcur 1 read maximum motor current of all available axes

7.11. etspresent (Read ETS Detect State)

Syntax: ?etspresent
Parameter: none

Description: Check if an ETS was detected by the TANGO (during power-up).

0 = No ETS found at the corresponding address
1 = ETS was found at the corresponding address (is available)

Up to 4 ETS can be controlled by one TANGO.
The ETS numbers are usually assigned as follows:

ETS 0 = XY stage
ETS 1 = Z axis
ETS 2 = Filter or Reflector Wheel
ETS 3 = Objective revolver

Remarks: If more than one ETS is found, the first one (lowest address) is treated as the 'main' ETS, the ETS with higher address only for the there defined axis specific parameters (e.g. axis 3).

Response: ASCII string of 4 characters, 0 or 1
 [ETS#0][ETS#1][ETS#2][ETS#3]

Example: ?etspresent => 0000 (no ETS connected)
 ?etspresent => 1000 (ETS found at address 0, usual case)
 ?etspresent => 1010 (ETS found at address 0 and 2)



7.12. stagesn (Read Connected Devices Serial Number)

Syntax: ?stagesn
 Parameter: none or -1,0,1,2,3

Description: Read the axis or XY-stage serial number(s) from the ETS.
 If the motor axis provides an ETS identification circuit, the serial number of the axis or connected unit (e.g. a microscope stage) is returned.

Call parameter options:

- None: 4 serial numbers are returned, one for each possible ETS address (0,1,2,3)
- -1 : 1 Serial number is returned, of the main ETS (usually also the only connected ETS, recommendet instruction)
- 0~3 : Addresses an individual ETS, usually only ETS#0 is available (which also responds to the -1 parameter)

Response: ASCII string(s) of 8 or 9 characters.
 The syntax is YYMMDDXXX or "-----" if no ETS available.

YY year of manufacturing
 MM month of manufacturing
 DD day of manufacturing
 XX(X) index number

Example: One ETS connected to the XY stage (at ETS address 0)

```
?stagesn      => 140328015 -----
?stagesn -1   => 140328015      (The ETS at address 0 is the "first" ETS)
?stagesn 0    => 140328015      (The ETS at address 0)
?stagesn 1    => -----
```

One ETS connected to the Z axis (here at ETS address 3)

```
?stagesn      => ----- 140328015
?stagesn -1   => 140328015      (The ETS at address 3 is the "first" ETS)
?stagesn 0    => -----
?stagesn 1    => -----
?stagesn 2    => -----
?stagesn 3    => 140328015      (The ETS at address 3)
```

Two ETS connected to the XY stage and the Z axis (here ETS addresses 0 and 1)

```
?stagesn      => 151125014 160714003 -----
?stagesn -1   => 151125014      (The ETS at address 0 is the "first" ETS)
?stagesn 0    => 151125014      (The ETS at address 0 is the "first" ETS)
?stagesn 1    => 160714003      (The ETS at address 1)
?stagesn 2    => -----
```

7.13. etstemp (Read the Optional Temperature Sensors)

Syntax: ?etstemp or etstemp
Parameter: -1,0,1,2,3 ETS address
and one to four sensor address(es) 48, 49, 4a (or 0x48/49/4a)

Availability: On axes with ETS (firmware ≥ 4) and temperature sensor and TANGO firmware ≥ 1.75 . Not available with TANGO-I.

Description: Read the temperature of the optional ETS temperature sensors.

Up to 3 temperature sensors can be connected to an/each ETS. The sensors are identified by their individual address. By default, the addresses are assigned as follows:
48 = Sensor 1 = X axis (usually at the encoder or lead screw)
49 = Sensor 2 = Y axis (usually at the encoder or lead screw)
4a = Sensor 3 (usually at a different position of the stage)
None, one, two or all three sensors can be available.

Each sensor temperature can be read out individually, or several sensors of an ETS at once. It is not possible to read several ETS addresses at once, only per ETS.

etstemp [ETS number] [Sensor addr] [optional 2nd] [opt. 3rd] ..

Remarks: Only available if a temperature sensor is present. Else, error 71 occurs.

Response: Temperature(s) of the specified ETS and Sensor in °C with 2 decimal places

Example: etstemp -1 48 => 27.41 (ETS with lowest address, Sensor 1)
etstemp 0 48 => 27.41 (ETS#0, usually XY-stage, Sensor 1)
etstemp 0 49 => 26.83 (ETS#0, usually XY-stage, Sensor 2)

etstemp 0 48 49 => 27.41 26.83 (ETS#0, Sensor 1+2)
etstemp 0 48 49 4a => 27.41 26.83 23.44 (ETS#0, Sensor 1,2+3)
etstemp 0 48 48 48 => 27.41 27.42 27.42 (read Sensor1 3 times)
etstemp 0 48 49 4a 48 (read Sensor 1,2,3 + Sensor 1 again)

7.14. maxpos (Maximum Position)

Syntax: ?maxpos

Parameter: x, y, z, a or none

Description: The maximum position value which the controller can accept. It depends on the configured **pitch**, **gear** and **motorsteps**.

Remarks: A move instruction must not exceed the maxpos distance, the maximum travel range of the axis is within \pm maxpos.

Response: Maximum position value of the axes (unit depends on 'dim')

Example: ?maxpos => 2600.0000 2600.0000 2600.0000
?maxpos x => 2600.0000 (positioning from -2600mm to +2600mm)

7.15. lockpos (TransportLock Position)

Syntax: ?lockpos

Parameter: x, y, z, a or none

Description: Read the factory set transportlock position, where the axis must be positioned to for the fixation screw/transportation. A value of zero indicates the position is not available.

Remarks: Refer to the **!mol** instruction

Response: Transportlock position

Example:
?lockpos => 50.3815 38.0018 0.0000
?lockpos y => 38.0018 (Y axis transportlock position)
?lockpos z => 0.0000 (Z axis provides no transportlock position)

7.16. cmdinfo (List of Available Instructions)

Syntax: ?cmdinfo or cmdinfo

Parameter: none, 1 or 2
and an optional 1

Availability: 2nd generation TANGOs (e.g. Desktop HE).

Description: Provides the number of instructions
or a multi-line list of available instructions.

The first parameter stands for the interpreter (ipreter),
whoms informations shall be returned.

Parameter1 = 1 or none: TANGO Native instructions
Parameter1 = 2 : Venus instructions

The optional second parameter "1" lists the instructions
of the requested interpreter as multi-line Text, the last
line terminates with "end."

Remarks: The number of instructions might not corrsespond with the
number of listed instructions (might contains less lines).

Response: Number or a multi-line ASCII-Text, last line is "end."

Example: cmdinfo 1 => 500 (amount of TANGO Native instructions)
cmdinfo => 500 (same as cmdinfo 1)

cmdinfo 2 => 241 (amount of Venus-1/-2 instructions)

cmdinfo 1 1 => err (list of TANGO Native instructions)
pos
readsw
...
end.

cmdinfo 2 1 => m (list of Venus instructions)
move
r
rmove
nm
nmove
...
end.

8. Communication Interface Settings

8.1. baud (Baud Rate)

Syntax: !baud or ?baud
Parameter: 1200, 2400, 4800, 9600, 19200, 38400, **57600** or 115200

Description: Set or read the baudrate of the serial COM Port interface(s).
The default baudrate to connect a TANGO is 57600.

When changing the baud rate on a true RS232C interface, the PC COM port also must change its baud rate to maintain communication (close and then re-open the COM Port with the new baud rate).

Then a '**!save**' instruction may be sent to permanently store the new baud rate in the controller.

Some TANGOs (like Desktop HE) provide two RS232 interfaces. When only using the main interface, the baud instruction works identical as with one interface only. The individual baud rates can be set with additional port identifier 1 or 2, refer to examples below.

Remarks: For communication via PCI, PCI-E or USB this instruction has no effect, as communication is managed by the driver at a very high, internally fixed baudrate. In this case it does not matter which baudrate the virtual COM port is opened with, it has no effect on performance.

Response: Current baud rate(s) of the controller

Examples: !baud 57600 Set the baud rate to 57600 [Bd]
?baud Read currently applied baud rate

Examples 2 RS232: !baud 1 57600 Set baud rate of the 1st RS232 interface
!baud 2 115200 Set baud rate of the 2nd RS232 interface
!baud 57600 115200 Set baud rate of both RS232 interfaces
?baud 1 Read baud rate of the 1st RS232 interface
?baud 2 Read baud rate of the 2nd RS232 interface
?baud -1 Read baud rate of both RS232 interfaces

8.2. cts (Enable/Disable RS232 Hardware Handshake)

Syntax: ?cts or !cts
Parameter: 0 or 1

Description: Only supported by TANGO PCI-S/DT-S and PCI-E/DT-E controllers.
Enable or disable RTS/CTS hardware handshake.

0 = no handshake (default)
1 = RTS/CTS handshake

Remarks: The COM port of the PC must be opened in the same hardware handshake mode.

Response: Currently selected cts mode 0 or 1

Examples: ?cts read the current handshake mode
!cts 0 disable RTS/CTS handshake (default, recommended)

8.3. rxtimeout (Receive Timeout)

Syntax: `?rxtimeout` or `!rxtimeout`

Parameter: `5 ... 10000 [ms]`

Availability: 2nd generation TANGOs (e.g. Desktop HE).

Description: Receive timeout after which received incomplete data is Discarded, if no character was received after this time (inter-character timeout). The default is 1000 (1second).

Response: Currently selected rxtimeout (5 ... 10000) ms

Examples: `?rxtimeout` read the current rxtimeout
`!rxtimeout 2000` set the timeout to 2000ms (2 seconds)

9. Communication Interface Settings for Ethernet

The TANGO Desktop HE provides an RJ45 connector for Ethernet communication. It is possible to communicate in an IPv4 network through Telnet Port 23, e.g. via Winsock or the TANGO-DLL. Therefore, **ipaddr**, **netmask** and **gateway** must be specified. Each TANGO Desktop HE has a unique **MAC-48 address**.

9.1. ipaddr (Network IP Address for TANGO)

Syntax: ?ipaddr or !ipaddr
Parameter: 0.0.0.0 to 255.255.255.255
or an optional 1 for reading

Availability: Only with TANGO Desktop HE from Firmware 1.74.

Description: IPv4-Address for network communication. Default = 0.0.0.0
The address is applied/changed immediately, without reset or reboot. By default, the specified address is returned. And, with with parameter '1', the currently used address.

Remarks: When changing the IP-address over Ethernet, the connection is lost (the TANGO discards it) and the client (PC) must reconnect with the new IP-address. A reboot of the TANGO is not required. Communication is also still possible over USB or RS232.

Response: Currently selected IP-address, without leading zeros

Examples: !ipaddr 192.168.1.15 set the TANGO IP-address
?ipaddr read the TANGO IP-address
?ipaddr 1 read the applied TANGO IP-address

9.2. netmask (Network Netmask)

Syntax: ?netmask or !netmask
Parameter: 0.0.0.0 to 255.255.255.255
or an optional 1 for reading

Availability: Only with TANGO Desktop HE from Firmware 1.74.

Description: Netmask for network communication. Default = 255.255.255.0
The address is applied/changed immediately, without reset or reboot. By default, the specified address is returned. And, with with parameter '1', the currently used address.

Response: Currently selected netmask, without leading zeros

Examples: !netmask 255.255.255.0 set the TANGO netmask
?netmask read the TANGO netmask
?netmask 1 read the applied TANGO netmask

9.3. gateway (Network Default Gateway)

Syntax: ?gateway or !gateway
Parameter: 0.0.0.0 to 255.255.255.255
or an optional 1 for reading

Availability: Only with TANGO Desktop HE from Firmware 1.74.

Description: Default Gateway Address of the network.
The factory-default setting is 192.168.1.254
The address is applied/changed immediately, without reset
or reboot. By default, the specified address is returned.
And, with with parameter '1', the currently used address.

Response: Currently selected default gateway, without leading zeros

Examples: !gateway 192.168.1.254 specify the networks default gateway
?gateway read the specified default gateway
?gateway 1 read the applied default gateway

9.4. macaddr (TANGO unique MAC Address for Ethernet)

Syntax: ?macaddr or macaddr
Parameter: none

Availability: Only with TANGO Desktop HE.

Description: Read the unique MAC-48 Address of the TANGO.
Every TANGO Desktop HE has its unique MAC address.

Response: MAC Address, formatted as NN:NN:NN:NN:NN:NN (N=hex number 0-F)

Examples: macaddr (read the MAC address, e.g.: 04:91:62:F0:E0:54)

9.5. disconnect (Network Connection Disconnect and Info)

Syntax: !disconnect or ?disconnect
Parameter: none or an optional 1 for reading

Availability: Only with TANGO Desktop HE from Firmware 1.74.

Description: Forced disconnect of the TANGO (=Server) from the Client (PC).

May be used if the client was not correctly disconnected from
The TANGO and still blocks the TANGO connection for access
through another network-application (then, the instruction is
only possible through another interface, e.g. USB or RS232).

The instruction can also be used to identify the network
connection status and infos about the connected client:

Response: ?disconnect → 0 the client connection is established
?disconnect → 1 there is no connection to a network client
?disconnect 1 returns 0.0.0.0 0 if no client is connected
or the client's IP address and port

Examples: ?disconnect => 0 (client connected)
?disconnect 1 => 192.168.100.105 57311 (client IP + port)
!disconnect (force TANGO to discard client connection)

10. System Instructions

10.1. save (Save Parameters)

Syntax: !save or save

Parameter: none

Description: The save instruction permanently stores the parameter settings (lead screw pitch, current, etc.) in the TANGO controller. These parameters will be applied as default values after each consecutive power-on or reset. Executing a save command always returns the "OK..." string when writing to the internal memory has completed successfully. Which settings are saved can be seen in the **"Brief Description of the TANGO Instruction Set"**. Save is limited to 1 million executions (2nd gen.: 4 million). For 2nd gen TANGOs it is possible to read the save executions count of the user and configuration memory with "?save".

Remarks: Best practice is to send a save instruction only when all axes are idle. At least for PCI-S/DT-S, PCI-E/DT-E controllers with 4 axes, a save should not be executed while the 4th axis is traveling. And for a TANGO 3 mini, a save instruction should not be executed while any axis is traveling in closed loop. The save instruction does not save POS3 parameters, use xsave.

Response: ASCII string "OK...", or "ERR" with error number

Example: save => OK... (The parameters were stored successfully)

10.2. restore (Restore Saved Parameters)

Syntax: !restore, restore or ?restore

Parameter: none or -1

Description: Reload or reset the saved parameters.

When called without parameter (restore, !restore, ?restore)

The controller reloads the parameter settings from its nonvolatile memory, same as it does at power-on or reset. But restore does not affect or restart the entire hardware.

?restore returns "OK..." or "ERR" (like the save instruction), Executing restore without a question mark does not reply. ?err then might be sent once after the restore instruction and will reply the err response (e.g. a 0) after restore has completed.

When called with parameter "-1" (restore -1, !restore -1)

The saved parameters (nonvolatile memory) will be deleted and set to the firmware defaults. The parameters then have to be checked and set to the hardware requirements by the user. Else it may cause damage (due to overcurrent, wrong pitch, limit switch types etc). Software reset is performed automatically.

There is no reply to the restore -1 instruction, ?err polling may be required as described with the software 'reset'.

Response: none, or "OK..." or "ERR" when using ?restore

Example: restore (reload the saved parameter set)
?restore (like restore, but with "OK..."/"ERR" reply)
restore -1 (reset the saved parameters to default)

10.3. reset (Force a Software Reset)

Syntax: !reset or reset
Parameter: none

Description: The controller is forced to perform a software reset. It is a restart similar to power on. Rebooting from reset might take more than 1 second, where the controller is not responding. There is no reply to a software reset.

Remarks: New TANGO controllers (Desktop HE) with built-in USB interface will also disconnect the USB connection during reset. Therefore, when not communicating via newer TANGO DLLs (1.399 or later), the virtual COM port must be disconnected and reconnected after sending the reset command (retry reconnect until successful, then continue as usual).

Wait for reboot after Reset:
For knowing if the controller has rebooted and is ready, data may be polled until it responds again. E.g. send '**?err**' until the controller responds:
Send ?err [wait 0.5s for response]
Send ?err [wait 0.5s for response]
...
Send ?err [wait 0.5s for response]
Send ?err => 0 [Response, controller is ready]

Response: none

Example: reset

10.4. pa (Enable or Disable the Power Amplifiers)

Syntax: !pa or !poweramplifier
 ?pa or ?poweramplifier

Parameter: 0, 1, 2, 3 or 4, the options for read are: none or -1

Description: Switch all motor amplifiers on/off or read amplifier state.
 If switched off, no motor current is flowing (high impedance).
 Amplifier switch off can also be caused by a short circuit,
 the PSE pin functionality or loss of motor supply voltage.
 Then an internal error (error 29) is generated and the status
 LED flashes. ?pa will return 0. After removing the switch-off
 cause, the amplifiers can be switched on again, e.g. by !pa 1.

PARAMETERS FOR THE SET INSTRUCTION (!pa)

- 0 : Amplifiers off
- 1 : Amplifiers on
- 2 : Special Closed Loop switch on instruction, see remarks
- 3 : Similar to 1, but keeps the XY cal/rm limits (caution!)
- 4 : Similar to 2, but keeps the XY cal/rm limits (caution!) 2nd

PARAMETERS FOR THE READ INSTRUCTION (?pa)

- none = read general amplifier state: 1 = ok, 0 = error or off
- 1 = read individual amplifiers : 1 = on, 0 = off

Remarks: To switch off individual axes, use the '**axis -1**' instructions.

 If the amplifiers switched off due to any condition or by the
 "!pa 0" instruction, and the axes were in active closed loop
 state before, it is possible to switch them on again and
 reactivate the closed loop at the current axis positions by
 sending "!pa 2". A **cal** or **rm** sequence is not required and the
 momentary measuring system positions of the axes are applied.
 For axes without encoders, "!pa 2" will behave like "!pa 1".
 "!pa 3" is only for open loop applications and where the X+Y
 axis positions did not change while the amplifiers were off.

 When using !pa 1 (or using !pa 2 without active closed loop),
 the **cal** and **rm** sequence must be executed again.

Response: amplifier state 0 = Amplifiers are off or at least one
 amplifier switched off (by error,PSE,!pa0)
 1 = Amplifiers are on

Example: !pa 0 Switch all amplifiers off

 !pa 1 Switch on all amplifiers, closed loop not recovered
 CAL/RM has to be repeated due to uncertain position.

 !pa 2 Switch on all amplifiers, closed loop is recovered.
 If axes were in closed loop before they switched off,
 they continue at their momentary position and CAL/RM
 is not required.

 !pa 3 Switch on all amplifiers, closed loop not recovered,
 XY CAL/RM state is recovered (→ useful in open loop)

 !pa 4 Only available with 2nd gen. TANGOs from Firmware 1.79

 ?pa Read amplifier state (e.g. returns 1)

 ?pa -1 Read amplifier state of all axes (e.g. returns 1 1 1)

10.5. paswitchoff (Power Amplifier Switchoff Reason)

Syntax: ?paswitchoff or paswitchoff
Parameter: none

Availability: 2nd generation TANGOs (e.g. Desktop HE) from Firmware 1.77
1st generation TANGO 3 mini from Firmware 1.78

Description: If the motor amplifiers switched off (error 29, ?pa = 0), the reason for switching off can be identified by requesting the paswitchoff state. If no internal errors lead to the amplifier switchoff (e.g. a !pa 0 or !axis -1) or in case of normal operation (no error), the return value is 0000. The returned value represents 16 bits as hex value 0-F, without a leading "0x".

ctrsm mode 5 (pa off on closed loop deviation) can lead to a pa switchoff reason in bits 0 to 7:

```
0001 = Closed Loop Deviation in X *
0002 = Closed Loop Deviation in Y *
0004 = Closed Loop Deviation in Z *
0008 = Closed Loop Deviation in A *
0010 = Encoder Error          in X
0020 = Encoder Error          in Y
0040 = Encoder Error          in Z
0080 = Encoder Error          in A
```

* Closed Loop Deviation might also occur in combination with (and then originally caused by) an Encoder Error (Bits 4-7).

Bits 8 to 15 represent internal errors or PSE as switchoff reasons:

```
0100 = 12 Volt error (TANGO intergale2: 3V error)
0200 = Supply voltage below umot min threshold
0400 = ASB overcurrent
0800 = ASB input voltage

1000 = PSE off
2000 = Temperature
4000 = Internal 5V
8000 = Motor voltage
```

Response: 4 digit hex value 0-9, A-F without a leading "0x"

Examples:

```
?pa          ==> 0      (amplifiers off →ask paswitchoff why)
?err         ==> 29
paswitchoff  ==> 0002  (closed loop deviation of Y-axis)

?pa          ==> 0
?err         ==> 29
paswitchoff  ==> 0022  (encoder error Y → closed loop of Y)

?pa          ==> 0
paswitchoff  ==> 0000  (?pa=0 was not caused by an error)
```

10.6. ipreter (Select Instruction Set)

Syntax: !ipreter or ?ipreter

Parameter: 1, 2, (3, 4 or 5)

Description: Select an instruction set for the TANGO (default = 1). The TANGO controllers provide up to 5 different instruction sets (called "interpreter" language). It is recommended to use the default interpreter 1, as it is the native language and supports the most complex instruction set available. Other instruction sets may be used for compatibility to existing applications. They are described in separate manuals.

INTERPRETER NR.

```
-----  
0   Not supported! (old register instruction set)  
  
1   TANGO instruction set (default),  
    as described in this manual  
  
2   VENUS-1 and VENUS-2  
  
3   LUDL MAC5000 **  
  
4   ASI MS-2000 (available with Firmware >= 1.46) **  
  
5   PRIOR ProScanII **  
-----
```

Remarks: If the interpreter should be changed permanently, the setting must be stored after changing the interpreter in the newly selected interpreter's language. Using "save" is valid in interpreter 1 or 2, for other interpreter languages check the syntax of the corresponding save instruction.

To return from the VENUS instruction set (2), please enter the string "1 setipreter" and press enter (or send an ASCII [CR]). For other instruction sets please refer to the corresponding instruction set description.

Switching back and forth between interpreter 1 and 2 is possible "on-the-fly" immediately during normal operation of the TANGO. No restart required.

2nd generation TANGOs only support interpreter 1 and 2.

** The additional interpreters 3, 4 and 5 are supported by the 1st generation TANGOs only (TANGO PCI-E / Desktop E, TANGO 3 mini, intergrale, TANGO-C / mini / pilot).

Response: 1

Example:

```
!ipreter 2      Switch the interpreter to VENUS instruction set  
?ipreter       Always returns 1 because when using this command, the TANGO  
               is in this 1st instruction set. Else, when the TANGO is set  
               to another interpreter, this instruction is not supported  
               and the corresponding interpreter's command must be used,  
               e.g. "getipreter" when in Venus, etc.
```

11. Operating Modes

11.1. autostatus (Set Autostatus Response Behavior)

Syntax: !autostatus or ?autostatus

Parameter: 0, 1, 2, 3 or 4

Description: Select the auto response behavior for completion of move and calibration instructions or instruction acknowledge. The power-up default (1) can be overwritten by **autopreset**. Move instructions !moa,!mor,m,!moc,!mol behave identical. Calibrate instructions are slightly different, ('A','D').

0 : Disable automatic status replies
(Except '!save' instructions will still return either "OK..." or "ERR")

1 : **Default state at power on. Recommended.**
Position reached response after an automatic move (!moa,!mor,m,!moc,!mol) as a 5 character string with e.g. '@' for each configured axis: "@@@@@"
!cal returns an 'A' instead of '@' and !rm returns a 'D'.
Disabling the joystick by "!joy 0" also causes a response.
Please refer to '**statusaxis**' for further explanation of the reply.

2 : Instructions with a leading "!" are immediately acknowledged by the **status message** ("OK..." or "ERR"). Move and Cal/Rm instructions will respond additionally like in autostatus 1 (e.g. "@@@-.", "AAA-.", "DDD-." response).

3 : Similar to the default mode 1, but a simple <CR> (0x0d hex) is returned to indicate that the move is completed. It can be used to improve performance for higher vector throughput, but contains less information e.g. concerning possible errors.

4 : Echoes instructions that have a leading "!" as they were received.
No error information is returned and no status reply after a move.

Example: !autostatus 0 disable autostatus ('**statusaxis**' must be polled to identify if the axis is traveling or stopped)
 !autostatus 1 set autostatus to the default behavior
 ?autostatus read the currently selected autostatus

--- autostatus 0 ---

!moa,!mor,m,a,cal,rm ==> [returns nothing, statusaxis (sa) must be polled]

--- autostatus 1 --- (the default mode after power on)

!moa,!mor,m,!moc,!mol ==> [returns completion: 5 ASCII character string @@@@.]

!cal x[CR]!rm y[CR] ==> [returns completion: 5 ASCII character string AD@@.]

--- autostatus 2 ---

!vel 10 ==> [returns "OK..."]

!vel -10 ==> [returns "ERR 5"]

vel 10 ==> [returns nothing (is executed but no "!" = no reply)]

--- autostatus 3 ---

!moa,!mor,m,a,cal,rm ==> [returns completion only as a <CR> termination]

--- autostatus 4 ---

!moa 10 5 0 ==> [returns just the "!moa 10 5 0" as it was received]

11.2. autopreset (Preset for autostatus)

Syntax: !autopreset or ?autopreset

Parameter: 0, 1, 2, 3 or 4

Availability: From Firmware 1.73

Description: Set or read the predefined power-up setting for **autostatus**. The TANGO will use it as preset value for **autostatus** after power-up or reset. Default = 1.

Remarks: As the **autostatus** setting is volatile and commonly used, e.g. by SwitchBoard or the DLL, it should not be storable. In cases where a certain autostatus mode is required at power-up, autopreset can be used.

Response: Selected autostatus mode for power-up and reset.

Examples:

```
!autopreset 0 Set power-up preset for autostatus to 0 (disabled)
?autopreset Read the autostatus preset value
```

11.3. Extended Mode

Activating Extended Mode provides new instructions for individual cal, rm and joystick velocities, which else are all just defined by vel. It also fixes some bugs with the swact, swpol, swtyp and lim reply.

Calibration in extmode = 0:

!vel --> The velocity for moving towards a limit switch has to be set everytime before starting a **cal** / **rm** move.
!calbspeed --> There is only one velocity for all axes to travel out of the Limit switch. The unit is 1/100 rev/s.

Calibration in extmode = 1:

!vel has no influence on the cal / rm move, also '**calbspeed**' is no longer used. Now the calibrate (**cal**) and range measure (**rm**) velocities can be assigned once and will be used as speed especially for those instructions.

!calvel --> Set velocities for moving towards and out of the cal switch (E0)
!rmvel --> Set velocities for moving towards and out of the rm switch (EE)

Additional differences when in extmode = 1:

If the pitch or gear parameter is changed, all parameters which are in revolutions/s (e.g. vel) are recalculated internally. The axis velocities will remain the same.

joyvel --> The joystick velocity can (and has to be) set independently from **vel** by the **joyvel** instruction.

The **?lim** instruction, when requested without an axis specifier, now returns all limits in a correctly formatted way.

11.3.1 extmode (Switch to Extended Mode)

Syntax: !extmode or ?extmode
Parameter: 0 or 1

Description: This instruction configures the TANGO extended mode. Extended mode offers improved behavior and additional instructions compared to the regular interpreter. For further information please refer to the **Extended Mode** Chapter 11.3.

Remarks: When initializing the controller, the desired Extended Mode should be set after setting **dim** and before setting gear, pitch, vel etc.

0 = default, compatible interpreter mode
1 = extended interpreter mode

Response: currently used extmode, 0 or 1

Examples:
!extmode 1 Set controller behavior to extended mode
?extmode Read extended mode setting

11.4. Scan Mode

By default, with ScanMode deactivated, a single axis move (moa or mor x,y,z,a) causes the specified axis to travel at its own velocity and in case several axes are specified (e.g. moa 10 5 3), up to four axes travel as a vector in order to reach their target positions at the same time. The velocity is recalculated in a way that none of the involved axes exceeds its velocity or acceleration limits.

This means the resulting vector velocity of a multi-axis vector move depends on the axis velocities and travel distances.

Scan Modes 1, 2 and 3 change this behavior:

In some cases, it's required that the resulting vector travel velocity is always the same, independent in which direction or angle the vector is pointing. This "continuous path velocity" (parameter '**scanvel**') is applied in ScanMode 1.

ScanMode 2 limits this behavior to multi-axis move instructions only. It causes single axis moves to use their individual velocity (**vel**), which can be used e.g. to drive the Z axis independently while X and Y still travel as a continuous path vector.

ScanMode 3 entirely disables vector moves. All moves, no matter if single axis or multi-axis, are traveling at their own velocity (**vel**) setting and so may reach their target position at different times (they stop individually). This mode is useful if the system configuration consists of individual axes.

ScanMode 3 might also be of advantage in stop-and-go line scans for image stitching, where X or Y is the scan axis and Z is required to follow a focus map = each position consists of an X position with its individual Z value. One axis might have already settled in its target position then (no more oscillating) when the other axis arrives. This might give an advantage in overall speed compared to the default mode, where the X and Z then would arrive (and oscillate and settle) in their target position at the same time.

11.4.1 scanmode (Scan Mode to change Axis Vector Move Behavior)

Syntax: !scanmode or ?scanmode

Parameter: 0, 1, 2 or 3

Description: This instruction switches the TANGO controller into scan mode, which may be used for continuous path control (modes 1,2) or special requirements of move behavior. Modes 1 and 2 apply a constant vector velocity for automatic moves (moa, mor) which is set by '**scanvel**'.

0 = normal operation (the default TANGO mode)

1 = scan mode 1

2 = scan mode 2

3 = no vector moves (else identical to mode 0)

Scan mode 0: Normal operation (TANGO default)

- Single axis moves travel at their individual vel and accel.
- Vector moves are calculated to reach the target position at the same time without exceeding a velocity or acceleration of any of the involved axes. Scanvel is not used.

Scan mode 1: Resulting move velocities are always scanvel

- The resulting travel velocity of automatic moves is **scanvel**.
- The individual '**vel**' settings are ignored.
- Applies to single axis and vector moves, e.g. "!moa x 10"→scanvel, "!mor 20 20"→x=y=scanvel/sqrt(2)

Scan mode 2: Only vector moves are executed at scanvel

- Similar to scanmode 1, but individually started axes now travel at their original '**vel**' settings. May be useful e.g. when the Z-axis controls the focus.
- The resulting travel velocity of a vector move is **scanvel**.
- The individual '**vel**' settings are used for single axis move, e.g. "!moa z -10"
- Scanvel only applies to vector moves of 2 or more axes, e.g. "!moa 10 20"

Scan mode 3: No vector moves

- Similar to mode 0 (normal operation, not a mode as 1 or 2).
- When using vector moves (move instruct. with several axes), each axis travels at its individual **vel** and **accel** settings.

Response: Scanmode (automatic move mode) as integer

Examples:

!scanmode 1 Set controller into scanmode 1 (always traveling at scanvel)
?scanmode Read controller scanmode

!vel 20 20 10 (example: vel x,y = 20, vel z = 10)

!scanvel 0.1

!scanmode 2

!moa 50 100 → vector move with scanvel (vector velocity is now 0.1mm/s)

!mor z 1.5 → single axis move executed with vel z (this example 10mm/s)

!scanmode 0 Disable scanmode (=default, normal operation)

!scanmode 3 No scanvel, vector moves now let each axis travel at its own vel x,y,z, a setting towards the target
e.g. !mor 10 10 5 starts each axis at its own vel setting

11.4.2 scanvel (Vector Velocity for Scanmode and Dissection)

Syntax: !scanvel or ?scanvel
Parameter: 0.000001 to 1000 [mm/s]

Description: This instruction sets or reads the '**scanmode**' vector velocity in millimeters per second. It is also used for the snapshot dissection mode (**sns** 3) continuous path velocity. There is only one parameter and the unit is always mm/s.

In **scanmode** 1, the resulting vector velocity of a move is always **secvel**, independent if 1, 2, 3 or 4 axes are started. In **scanmode** 2, only vector moves of multiple axes use **scanvel** as vector velocity, while individual axes (e.g. by **mor z 1**) use their own velocity. Used e.g. for XY vector and Z focus.

Remarks: The **secvel** velocity limit will be applied to the individual axes as long as they are not calibrated and range measured (when **cal + rm** are not executed yet).

Response: Currently selected scanmode velocity in [mm/s]

Examples:
!scanvel 0.1 Set scanmode vector velocity to 0.1 mm/s
?scanvel Read scanmode velocity (returns e.g. 0.100000)

11.5. ModuloMode

The Modulo Modes can be used for turntables, swiveling axes, or for endless rotating applications such as pumps, fans, etc. to run at constant **!speed** in linear mode 0, the speed would stop latest at the maxpos limits. Modulo Modes are ment to work with **dim** 3 or 4 (position of 0...<360 or 0...<1). **Dim** 0 and the **usteps** setting can also be used for a custom "unit". One revolution is always related to the turntable. It can be achieved by setting **gear**, or in case of rational numbers, **gear** and **pitch** accordingly. If a measuring system is attached to the turntable, its encperiod calculates as 1/[encoder line count/rev], if it is attached to the motor, the pitch and gear ratio must be taken into account: [lines/rev]*(gear/pitch).

11.5.1 modulomode (Linear or Turntable Modes)

Syntax: !modulomode or ?modulomode

Parameter: x, y, z, a or none
0, 1, 2, 3 or 4

Description: The Modulo mode sets the specified axes from the default linear into a turntable mode, where the position remains within one revolution of the motor or of the turntable.

- 0 : Modulo Mode off (default mode, e.g. for linear axes)
Required for most applications.
- 1 : Travel shortest distance to target position
automatically decides to travel forward or backward
This mode is also made for endless rotation with **speed**
- 2 : Only travel in positive direction (forward)
If the target position is below the current position, the axis travels once around to reach it (e.g. 359°->358°)
- 3 : Only travel in negative direction (backward)
If the target position is above the current position, the axis travels once around to reach it (e.g. 358°->359°)
- 4 : Do not travel over Zero
e.g. for swiveling axes <360° with limited operation range or as a cable tear-off protection
the axis remains within one revolution or the limits, travels forward and backward

Modes 1,2 and 3 ignore the upper and lower limits of the axis. While mode 4 uses the limits (**cal,rm,lim**) in order to narrow the possible operating range.

It is possible to switch between the modes (especially 1,2,3) during operation (typ. before a move instruction), to achieve the momentarily required behavior.

Remarks: In Modulo Mode, Closed Loop acts weaker at the zero position.

Response: Currently selected modulo mode(s)

Examples:

```
!modulomode 0 0 1 (set Z axis to modulo mode 1, X and Y to linear, A unchanged)
!modulomode a 4 (set A axis to modulo mode 4)
?modulomode => 0 0 1 4 (returns modulo mode of all axes, here: of 4 axes)
?modulomode z => 1 (returns modulo mode of Z axis, here: e.g. 1)
```

11.6. External Display Mode

TANGO controllers with dual interface (USB and RS232) can be configured to support the external position display "PROFILER SCD CL". This display unit connects to the TANGO through RS232.

The TANGO encoder- or motor-position is displayed, same as of a "?pos" request. If the TANGO uses position correction, the corrected position is shown.

With display enabled (by "**!configdisplay 1**"), the TANGO sends position and status data over its RS232 interface. The RS232 then can't be used for communication with the PC anymore; the PC must be connected via USB.

11.6.1 configdisplay (Configure External Display)

Syntax: !configdisplay or ?configdisplay
Parameter: 0 or 1

Description: This instruction enables or disables the external position display "PROFILER SCD CL".

0: disable external display (normal RS232 operation)
1: enable external display (RS232 occupied by display)

Remarks: Only available if TANGO has two interfaces (USB and RS232, or PCI-E and RS232), e.g. TANGO DT-E/PCI-E, TANGO 3 mini or Desktop HE. TANGO firmware 1.67 or higher is required.

Response: Currently selected configuration (0 or 1)

Examples: !configdisplay 0
 ?configdisplay

11.7. Other External Devices on RS232

11.7.1 configwsz (Configure W&S Piezo-Z Stage)

Syntax: !configwsz or ?configwsz
Parameter: 0 or 1

Description: This instruction enables or disables the external W&S Piezo-Z Controller, connected via RS232.

0: disable (normal RS232 operation)
1: enable (RS232 occupied by Piezo-Z Controller)

Then, the "pz" instructions are available for controlling the Piezo-Z stage: pzcal, pzrm, pzmoa, pzmor, pzpos. Refer to chapter "**Piezo-Z Controller Instructions**".

Remarks: Only available if TANGO has two interfaces (USB and RS232, or PCI-E and RS232), e.g. TANGO DT-E/PCI-E, TANGO 3 mini or Desktop HE. TANGO firmware 1.73 or higher is required.

Response: Currently selected configuration (0 or 1)

Examples: !configwsz 1
 ?configwsz

11.7.2 configturret (Configure Nikon FL-Turret)

Syntax: !configturret or ?configturret

Parameter: 0 or 1

Description: This instruction enables or disables the external Nikon FL-Turret, connected via RS232 over an adapter.

Remarks: It is also used for the external Märzhäuser Filter Wheel with integrated controller, if connected to the TANGO via RS232. Then, the FL-Turret instructions are used in a slightly different way, like the MW Filter Wheel. Refer to the comparison chart in chapter 31: "**External MW Filter Wheel Instructions**".

0: disable (normal RS232 operation)

1: enable (RS232 occupied by Nikon FL-Turret)

Then, the **Nikon FL-Turret instructions** become available.

Remarks: Only available if TANGO has two interfaces (USB and RS232, or PCI-E and RS232), e.g. TANGO DT-E/PCI-E, TANGO 3 mini or Desktop HE. TANGO firmware 1.74 or higher is required.

Response: Currently selected configuration (0 or 1)

Examples: !configturret 1
?configturret

12. Controller States and Error Messages

12.1. statusaxis (Read State of Axis)

Syntax: ?statusaxis or statusaxis, ?sa or sa

Parameter: x, y, z, a or none

Description: Statusaxis (sa) returns the state of each axis. Similar to the 'autostatus 1' response for move instructions, but with an additional '-' after the dot (.- instead of .). It can be used for polling move states when in 'autostatus 0' mode, where no automatic response is generated.

Every response except of 'M' means the axis has stopped for some reason and may be ready for a new move instruction.

It is recommended to check the returned ASCII character for != 'M' (not equal to 'M', 0x4D hex) or == 'M' only.

Remarks: Statusaxis (sa) reports similar to the **autostatus** reply. It does not report manual moves from the HDI (e.g. joystick), Only move, go, cal/rm or speed instructions cause 'M' replies. This is, because manual HDI moves will be interrupted by those Instructions and no waiting for HDI (joystick) is required.

Hint: The '**sta**' instruction contains much more details about the axis states. It is available from Firmware 1.73 and higher.

Response: 6 ASCII characters: [STATUS X][STATUS Y][STATUS Z][STATUS A].- or with specified axis x,y,z,a: 1 ASCII character

J => Axis is ready and may also be controlled manually (joystick enabled)

@ => Axis is not moving and ready, joystick (HDI) is disabled

M => Axis is moving

- => Axis is not available in hardware

For the 'statusaxis'/'sa' instructions, the following states have lower priority and might be superseded when the joystick is globally enabled (?joy is not 0) by the above listed 'J'.

Then the following stzates only appear in an **autostatus 1** reply of a move:

S => Limit switches are actuated and prevent further automatic move

A => ok response after cal instruction

D => ok response after rm instruction

E => error response, move aborted or not executed (e.g. **cal** or **rm** error, or stop input active)

T => Timeout occurred (refer to '**caltimeout**' instruction)

Example: For a 3-axis controller

```
?statusaxis => JJJ-.- (same as "sa"-responses shown below)
sa           => JJJ-.- (all axes idle, no running move, joystick on )
sa           => @@@-.- (all axes idle, no running move, joystick off)
sa           => JMJ-.- (Y axis is traveling , joystick on )
sa           => MMM-.- (all 3 axes are traveling)
sa y        => M      (Y axis is traveling)
```

Example for idle 4-axis controller, joystick enabled: sa => JJJJ.-

Example for idle 3-axis controller, joystick enabled: sa => JJJ-.-

Example for idle 2-axis controller, joystick enabled: sa => JJ--.-

Example for idle 1-axis controller, joystick enabled: sa => J---.-



12.2. sta (Read Detailed State of Axis)

Syntax: ?sta or sta

Parameter: x, y, z, a or none

Description: Sta returns a detailed state of the axes as 32bit HEX values.

Remarks: Available only form TANGO Firmware versions 1.73 and higher.

Response: 32bit HEX number(s) 00000000 to FFFFFFFF,
amount (1 to 4) depending on axis count or requested axis.

```

00000001 !axis is set to 0 or 1 (motor current is on)
00000002 !axis is set to 1      (enabled) (axis -1= no 1 or 2)
00000004 motor power amplifier is on
00000008 motor power amplifier error

00000010 corresponds to statusaxis 'M' state of the axis
00000020 the axis travels due to HDI deflection (e.g.joystick)
00000040 cal is running
00000080 rm is running

00000100 cal already executed ('A' in statuslimit)
00000200 rm already executed ('D' in statuslimit)
00000400 lower limit switch E0 actuated (1 in readsw)
00000800 upper limit switch EE actuated (1 in readsw)

00001000 axis move waits for snapshot signal (sns 6)
00002000 calrequired prevents axis move, no cal/rm yet
00004000 1D position correction active
00008000 2D position correction active (@ Z reply: 2D+z)

00010000 encoder is active (?enc)
00020000 encoder was activated, even if enc currently disabled
00040000 reserved
00080000 encoder error (encerr)

00100000 closed loop is on
00200000 closed loop is active, regulating
00400000 closed loop is in target window (set by twi)
00800000 closed loop is in lock-in range (set by ctrs)

01000000 stop signal is active
02000000 HDI is enabled for this axis (joy+joydir)
04000000 Thermal compensation temperature is updatet, no error
04000000 Thermal compensation is applied, was activated by cal

10000000 Macro execution (macro is running)      2nd gen. TANGOs
20000000 Cal Learn data for encoder (callrnpos)  Firmw. ≥ 1.782
40000000 Cal Learn data for motor   (callrnposmot) Fw. ≥ 1.782
80000000 reserved

```

```

Example: sta x => 02030307  axis is not traveling, no closed loop, no errors
                | | | |
                | | | +- axis is on (!axis x 1, !pal)
                | | +--- cal and rm are executed
                | +----- encoder is active (and was/is active)
                +----- HDI is enabled (joy+joydir)

```

```

sta  => 02030307 02030307 00000007 (reply of a 3 axis TANGO)
sta z => 00000007

```

12.3. calst (Read Calibration State of Axis)

Syntax: ?calst or calst
Parameter: x, y, z, a or none

Availability: From TANGO Firmware 1.70 and higher.

Description: Calst returns the calibration state of one or all axes. Similar to the '**statuslimit**' instruction, it contains the information if the cal or rm routines were executed or not. But In a more easy readable way, as a sum of bits.

0 : Neither Cal nor Rm executed yet
1 : Cal executed, Rm not
2 : Rm executed, Cal not
3 : Cal and Rm executed (=1+2)

It is recommended to check the return value bitwise (by &1,&2) to allow addition of further states for future extensions of this instruction.

Remarks: May also be used to identify if secvel is released due to executed cal+rm, but therefore better use "**?secvel -1**".

Response: Decimal numbers with containing the bit representation of the cal and rm executed states. One value per axis.

Example: calst => 3 3 1 (CAL+RM executed for X and Y, Z only CAL)
calst z => 1 (CAL executed for Z, RM not)

12.4. calresult (Read the Result of the last Cal Instruction)

Syntax: ?calresult, calresult or !calresult
Parameter: x, y, z, a or none

Availability: 2nd generation TANGOs (e.g. Desktop HE) from Firmware 1.77.

Description: Returns the result of the last **cal** instruction (not for rm). Useful if cal failed (returned an 'E') to identify the reason.

0 : no result (cal not or not yet executed)
1 : cal was successful
2 : cal failed, no specific error available
3 : cal failed: caltimeout reached
4 : cal failed: internal timeout
5 : cal failed: aborted by abort instruction (!a)
6 : cal failed: cal routine was stopped
7 : cal failed: autopitch execution failed
10: cal failed: internal encoder claim timeout
11: cal failed: encoder was not activated
20: cal failed: encoder reference not found
21: cal failed: encoder reference fine detection failed
3n: cal failed: calibration on reference mark failed

The result is resetted by the next cal instruction or by !calresult (x,y,z,a, or no axis to reset all results).

Response: Decimal numbers 0 to 255, one per axis.

Example: calresult x ==> 0 (cal not yet executed in X)

12.5. corrst (Read Position Correction State)

Syntax: ?corrst or corrst
Parameter: x, y, z, a or none

Description: Read the state of position correction.
Bits 0 and 1 are for 1D correction (usual per axis correction)
While bit 2 is a general information that any correction is currently active. Then bit 5 can be checked if it is 2D or 1D correction. Bits 3, 4 and 5 are for 2D correction available from Firmware 1.73.
When 1D correction data is available and requested (Bits 0+1), a cal instruction activates it (Bit 2).

Bit 0 (1) = 1D correction data available
Bit 1 (2) = correction activation requested (by '!corr 1')
Bit 2 (4) = correction is active (1D and/or 2D, 2D+z)
Bit 3 (8) = 2D correction data available (X,Y)
Bit 4 (16)= 2D correction data available (Z) replied by Z axis
Bit 5 (32)= 2D correction is active XY, 2D+z reports on Z axis

Response: Bit coded integer number 0...63 per axis

Example: corrst => 7 3 0 (X: 1D active, Y: 1D available, Z: no data)
corrst x => 7 (X: Bit 0,1,2 are 1 = 1D correction active)

12.6. status (Read the Controller Error State)

Syntax: ?status or status
Parameter: none

Description: The ?status instruction responds with the current state of the controller. Which is either 'OK...' or an 'ERR' with the error number. The error number description can be found in chapter **Error Numbers**. Also refer to '**err**' and '**help**' instructions.

Response: OK... or ERR with error number

Example: ?status => ERR 4
 ?status => OK...

12.7. err (Read Error Number)

Syntax: ?err or err, !err
Parameter: none

Description: The 'err' instruction returns the controller error state or 0, if no error occurred. The error state reflects the error of the previously sent instruction or an internal error. The 'err' or '?err' read instruction does not change the error state (the error state remains). The error state can be cleared to zero by sending '!err', except it is a permanent error as e.g. error 29.

Response: Error number as decimal value
 Refer to Chapter 5: **Error Numbers**

Remarks: Errors can be caused by instructions, e.g. if there is a typo or if the parameters are not accepted etc. Those error numbers are typically in the range of 1 to 10. Each instruction overwrites the error state, so 'err' only corresponds to the previously executed instruction. If the previously executed instruction returned no error, the 'err' response is either 0 or if an internal error state is active, the internal error is returned. Those error numbers are typically 20 and above. Also refer to the '**help**' instruction.

Example: err => 0
 ?err => 0 (same as err)

 ?err => 5
 !err (clears the error state to 0 if not a permanent error)
 ?err => 0

12.8. help (Read Error Number with Description String)

Syntax: ?help or help
Parameter: none or any error number

Description: In addition to '**err**', help returns an describing text about the momentary error state or about a specified error number. It contains the error state with appended error description. By reading help, the error state is not changed or cleared to zero. Please also refer to the '**err**' instruction.

Called without a parameter:

It returns the controller's error state with description

Called with a parameter (error number):

It returns this error with its corresponding description

Response: Error number as decimal value, error description as ASCII text

Example: help => ERROR 0,no error (text for actual err)
 help => ERROR 5,number outside range (text for actual err)
 help 29 => ERROR 29,servo amplifier off (text for err no. 29)

12.9. cmderr (Command Error List)

Syntax: ?cmderr, cmderr or !cmderr
Parameter: none

Availability: 2nd generation TANGOs (e.g. Desktop HE).

Description: Provides a multi-line list of up to 15 recent instructions that produced an error. Each line stands for an error that was returned by the instruction. The last line terminates with "end."

It can be used to check, if an instruction or parameter was not accepted due to availability, syntax, parameters or !/?.

Sending '!cmderr' clears the error list, discards all entries.

The error lines start with the oldest entry and each error line consists of 4 informations:

1. Time that passed since the error occurred [hh:mm:ss:ms]
2. Error number caused by the instruction (refer to ?**err**)
3. The instruction with '!'/ '?' or in "" if not supported/typo
4. Axis x/y/z/a, if available

The sent parameters are not contained in the list.

Response: Multi-line ASCII-Text, last line is "end."

Example: cmderr => 00:01:30.947 err: 4, cmd unknown: "posx"
 00:01:22.619 err: 6, cmd: ?pos x
 00:01:15.455 err: 6, cmd: ?pos
 00:01:08.898 err: 5, cmd: !vel
 end.

 !cmderr (Clear the cmderr list)

 cmderr => end. (No command error, returns only "end.")

12.10. service (Print Service Information to Terminal)

Syntax: ?service or service
Parameter: none

Description: Returns a multi-line parameter and state list of the TANGO Controller. It may be used for debugging or in case of service requests. Either a terminal program or SwitchBoard version 1.19 and above can be used.

Response: Many lines of text including e.g. serial number, parameters, states etc. Each line terminated by a [CR]. From TANGO firmware 1.60C/1.61 (September 02, 2015) and later, the last line sends the string "END_SERVICE_PRINT." indicating the end.

Example: service

12.11. pci (Is PCI Bus)

Syntax: ?pci or pci
Parameter: none

Description: Check if the TANGO controller is used as PCI/PCI-E card (plugged into a PC slot).

0 = Controller is a desktop version
1 = Controller is a PCI or PCI-E card, plugged in the PCI(-E) slot of a computer (here: no RS232 or USB communication)

Response: 0 or 1

Example: pci => 0 (e.g. a TANGO Desktop)

12.12. isvel (Read Actual Velocities)

Syntax: ?isvel or isvel
Parameter: x, y, z, a or none

Description: Read the actual velocity(ies) at which the axis is currently traveling. Unlike '?vel' or '?speed' this instruction returns the currently traveled (true) speed of the axes, even when controlled by a HDI device.

Optional read-resolution: As an option to read the value with higher precision, the number of required decimal places can be specified with the query "?isvel [0...16 decimal places]". If no precision is defined, the default resolution is 3 decimal places.

Response: Actual axis velocity in [mm/s]
with default 3 or specified 0 - 16 fractional digits

Example:
?isvel Read actual velocity of all axes
?isvel y Read actual velocity of the Y axis (e.g returns 10.000)
?isvel 4 Read actual velocity of all axes with 4 fractional digits
?isvel y 6 Read actual velocity of the Y axis with 6 decimal places
isvel Same as ?isvel



12.13. iscur (Read Actual Motor Current)

Syntax: ?iscur or iscur

Parameter: x, y, z, a or none

Description: Read the momentarily applied motor current, which includes current reduction or switched off states (by **axis -1**).

Remarks: It is not a measured value.

Response: Applied motor current in [A] with 2 fractional digits

Example:

?iscur Read applied motor current of all axes

?iscur y Read applied motor current of the Y axis (e.g returns 1.00)

iscur Same as ?iscur



13. General Adjustments

With the following instructions the parameters of the controller are widely scalable to the given mechanic construction and to customer requirements. The controller is adaptable to the requested requirements.

13.1. dim (Unit for Positions and Velocities)

Syntax: !dim or ?dim
Parameter: x, y, z, a or none
0 to 10

Description: The dim instruction sets the unit (here "dimension") of the input and output parameters related to length, e.g. position or move instructions. Dim 9 and dim 10 also sets the velocity parameters to mm/s (e.g. '**vel**', '**speed**'), which else are in motor revolutions per second. Dim 9 and 10 are improvements of dim 2 and 1, which then behave as if dim 2 or 1 would had a pitch and gear of 1. As most axes no longer have a 1mm lead screw, using dim 9 or 10 simplifies setting vel and speed to the correct values. Dim 10 is available from Firmware 1.73.

```
0 = Micro steps **
1 = µm
2 = mm (the default: velocities in motor revolutions/s)
3 = 360° (position is displayed in 0...<360°) *,***
4 = revolutions *
5 = cm
6 = m
7 = inch
8 = mil (1/1000 inch)
9 = mm (difference to dim 2: all velocity units in mm/s)
10 = µm (difference to dim 1: all velocity units in mm/s)
```

Remarks: * **For dim modes 3 (=360°) and 4 (=revolutions) it is recommended to set the 'pitch' to 1 mm.**

** In dim mode 0, the amount of microsteps per revolution can be specified by the **usteps** instruction. This provides compatibility to existing software (which e.g. might require 40000, 50000, 51200 or 54000 steps/rev) as well as giving flexibility in defining own requirements (e.g. 360 steps/rev). As the internal resolution of the TANGO is not affected, the full resolution can still be accessed by using fractional ustep values (e.g. "**!moa** 39000.22" or "**!mor** 178.63"). While reading back the position will not contain fractional digits.

*** In dim mode 3, the position is displayed within 0...<360°, but in case of **modulomode** = 0, the true position might be several times 360° greater. Which might cause multiple turns in absolute positioning in dim=3 and **modulomode**=0.

Response: Current dim settings (integer value between 0 and 10)

Examples:
!dim 4 1 set dim unit for X to [revolutions] and for Y to [µm]
!dim z 9 set dim unit for Z to [mm and mm/s]
!dim 2 2 2 set dim unit for axes X, Y and Z to [mm]
?dim read dim unit for all axes
?dim a read dim unit of A-axis only

13.2. pitch (Spindle Pitch)

Syntax: `!pitch` or `?pitch`
Parameter: `x, y, z, a` or none
0.0001 to 72 [mm/rev] (from firmware 1.77 up to 100 mm/rev)

Description: This instruction sets or reads the lead screw pitch which defines the axis travel distance in millimeter per motor (or gear) revolution.

Optional read-resolution: The pitch parameter can be read with more fractional digits than the default 4 decimal places. Therefore, the number of required decimal places can be sent with the query `"?pitch [0...16 decimal places]"`. See examples.

Remarks: If pitch is an infinite number due to a 1/x function, the '**gear**' parameter can be used instead or in combination.

Response: currently used spindle pitch in [mm per motor revolution]

Examples:

```
!pitch 4 1    set lead screw pitch X=4[mm] and Y=1[mm]
!pitch z 28.895  set lead screw pitch Z=28.895[mm]
?pitch        read lead screw pitch of all axes (e.g. returns 1.0000 1.0000)
?pitch a      read lead screw pitch of A-axis only
?pitch 9      read lead screw pitch of all axes with 9 decimal places
?pitch y 6    read pitch of Y-axis with 6 decimal places (1.000000)
```

13.3. gear (Gear Ratio)

Syntax: `!gear` or `?gear`
Parameter: `x, y, z, a` or none
0.001 to 1000

Description: This instruction sets or reads the axis gear ratio. The value defines how many motor revolutions must be made to achieve one revolution at the gear output. If there is no gearbox mounted to the axis, gear should be left at its default value of 1.

Optional read-resolution: The gear parameter can be read with more fractional digits than the default 3 decimal places. Therefore, the number of required decimal places can be sent with the query `"?gear [0...16 decimal places]"`. See examples.

Remarks: If the gear value is an infinite number due to a 1/x function, '**pitch**' can be used instead or in combination with gear.

Response: currently used gear ratio(s)

Examples:

```
!gear 10    set gear ratio X=1:10 (motor makes 10 turns and the axis one)
!gear 4 1 1  set gear ratio X=1:4, Y and Z=1:1
!gear z 12.5  set gear ratio Z=1:12.5
?gear        read gear ratio of all axes
?gear a      read gear ratio of A-axis only (e.g. returns 1.000)
?gear 9      read gear ratio of all axes with 9 decimal places
?gear z 10   read gear ratio of Z-axis only with 10 decimal places
```

13.4. motorsteps (Motor Steps Per Revolution)

Syntax: !motorsteps or ?motorsteps

Parameter: x, y, z, a or none
4 to 65532 as multiples of 4

Description: This instruction sets the steps per revolution of the motor, which can be found in the datasheet. Common motors have 200 steps per revolution (1.8° full step). This is the TANGO default value. Other motors may have e.g. 400, 500 or 24 steps per revolution. It is essential for operation to have this parameter set according to the datasheet. The motor steps parameter must be a multiple of 4 in the range of 4 to 65532.

Response: Selected motorsteps of the stepper motor(s)

Examples:

!motorsteps 200 200 400	set motor steps for X and Y to 200 and Z to 400
!motorsteps x 500	set motor steps for X to 500
?motorsteps	read motorsteps of all axes
?motorsteps a	read motorsteps of A-axis only

13.5. accel (Acceleration)

Syntax: !accel or ?accel
Parameter: x, y, z, a or none
0.0001 to 20 [m/s²]

Description: This instruction sets or reads the acceleration which is used for all moves, the speed instruction and manual control by HDI devices. The acceleration is also used for deceleration.

Optional read-resolution: Accel can be read with a higher resolution than the default 2 decimal places. To read accel with more (or less) decimal places, the number [0 to 10] can be specified with "?accel [0...10]". Values greater 10 are accepted but reduced to 10. See examples below.

Remarks: In case of a stop event, '**stopaccel**' is used instead.

Response: Currently used acceleration in m/s²
with default 2 or specified 0 - 10 fractional digits

Examples:

```
!accel 0.5      set acceleration X=0.5[m/s2], other axes are not affected
!accel 1 0.123456 set acceleration X=1.0[m/s2] and Y=0.123456[m/s2]
!accel z 0.2    set acceleration Z=0.2[m/s2], other axes are not affected
?accel         => 1.00 0.12 0.20          (read acceleration of all axes)
?accel y      => 0.12                    (read Z axis acceleration)
?accel 6      => 1.000000 0.123456 0.200000 (read accel with 6 dec. places)
?accel y 4    => 0.1235                  (read Y accel with 4 dec. places)
?accel y 10   => 0.1234560000
?accel y 16   => 0.1234560000
```

13.6. accelfunc (Acceleration Ramp Function)

Syntax: !accelfunc or ?accelfunc

Parameter: x, y, z, a or none
0, 1 or 2

Description: Select the acceleration ramp type for automatic moves (e.g. m, moa, mor, moc, mol, moe, cal, rm).

- 0 = constant acceleration and deceleration
- 1 = s-curve acceleration and deceleration
- 2 = reserved, currently behaves as 1 (s-curve)

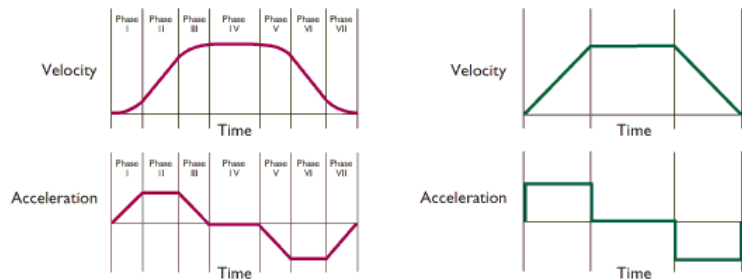

s-curve accel (1)

constant accel (0)

Remarks: For both, constant (0) and s-curve (1) acceleration, the acceleration time at the same accel is identical. Also, the position where the acceleration ramp ends is identical.

s-curve might be used to introduce less shake in the system, but for smaller step sizes of about <1mm the linear acceleration might be better, as the s-curve has a twice as high acceleration in the ramp center.

The acceleration ramp for **go**, **speed**, **a** and manual control via HDI always remains constant accelerated (0). The deceleration ramp is same as acceleration ramp.

Response: Currently used acceleration type

Examples:

```
!accelfunc 1      set accel type X to s-curve, other axes are not affected
!accelfunc x 1    set accel type X to s-curve, other axes are not affected
!accelfunc 1 1 0  set accel type in X and Y to s-curve, Z to constant
?accelfunc        read acceleration ramp type of all axes
?accelfunc z      read acceleration ramp type of Z axis only
```

13.7. stopaccel (Emergency Stop Deceleration)

Syntax: !stopaccel or ?stopaccel

Parameter: x, y, z, a or none
0.001 to 200 m/s²

Description: This instruction sets the deceleration for emergency stop conditions. It will be used by:

- abort instructions
- active stop input
- a '**cal**' or '**rm**' move (at the limit switch)
- when detecting an unexpected limit switch

Optional read-resolution: As an option to read the parameter with higher precision, the number of required decimal places can be specified with the query "?stopaccel [0...10 decimal places]". If no precision is defined, the default resolution is 2 decimal places.

Response: Deceleration for stop conditions in [m/s²]
with default 2 or specified 0 - 10 fractional digits

Examples:

```
!stopaccel 1 1 2 Set the stop deceleration for X and Y to 1 and Z to 2 [m/s2]  
!stopaccel x 1.5 Set the X stop deceleration to 1.5[m/s2]  
?stopaccel Returns the stop deceleration of all axes  
?stopaccel z Returns the stop deceleration of Z axis only (e.g. 1.50)  
?stopaccel 6 Returns stop deceleration of all axes with 6 fractional digits  
?stopaccel z 9 Returns stop deceleration of Z axis with 9 fractional digits
```

13.8. vel (Velocity)

Syntax:	!vel or ?vel
Parameter:	x, y, z, a or none 0.000001 to 200 [rev/s] (or up to 3000 [mm/s] at dim 9 and 10)
Description:	Velocity for automatic moves, cal**, rm** and HDI** (Remarks) The velocity unit is motor revolutions per second, except of dim 9 and 10, which both provide mm/s. Optional read-resolution: As an option to read the parameter with higher precision, the number of required decimal places can be specified with the query "?vel [0...16 decimal places] ". If no precision is defined, the default resolution is 3 decimal places.
Remarks: **	If extmode =0 (default), vel is also used for <ul style="list-style-type: none">• the HDI (joystick) velocity• the cal and rm instructions extmode =1 provides separate parameters (joyvel, calvel, rmvel). Vel can be used to change the travel velocity during a go instruction. In such case, setting vel to zero will also end a running go instruction (e.g. !vel z 0, !vel 0 0 0, etc.) The velfac instruction can be used in addition to vel, but is not necessary or recommended. When changing the vel during a move (moa, mor, limmove, etc.), the new velocity will be applied on the next move, the running move will still complete at the previous velocities where it was started with. The joystick velocities and a running "go" move will apply the new vel immediately, even while moving.
Response:	Currently selected velocity in rev/s, or mm/s at dim 9+10 with default 3 or specified 0 - 16 fractional digits
Examples:	<pre>!vel 1.5 15 set velocity X=1.5[revolution/s] and Y=15[revolution/s] !vel y 0.123456 set velocity Z=0.123456 [revolution/s] ?vel read velocity of all axes ?vel x read velocity of X axis only ?vel 6 => 1.500000 0.123456 10.000000 ?vel y 4 => 0.1235</pre>

13.9. velfac (Velocity Factor)

Syntax: !velfac or ?velfac

Parameter: x, y, z, a or none
0.01 to 1.00

Description: This instruction sets or reads the velocity factor, which is used for all consecutive automatic moves. It is internally multiplied to the velocity (**vel**) and affects the positioning instructions moa, mor, moc, moe, m, cal, rm. It does not affect instructions like go or speed.

Remarks: Velfac is just for backward compatibility and not required anymore, as the **vel** resolution is high enough to achieve the full spectrum of velocities.

Response: Velocity factor (0.01 to 1.00) with 2 decimal places

Examples:

```
?velfac          read velocity factor of all axes, e.g. 1.00 1.00 1.00
?velfac z       read velocity factor of Z axis only, e.g. 1.00
!velfac x 0.1   set velocity factor of X axis to 1/10 of specified velocity
!velfac 1 1 1   set velocity factor of X,Y,Z to specified velocity (default)
```

13.10. secvel (Secure Velocity)

Syntax: !secvel or ?secvel
Parameter: x, y, z, a or none
0.000001 to 100 [mm/s] or -1 for reading the secvel state

Description: The secure speed limitation is intended to prevent mechanical damage when the controller does not know the mechanical limits of the axis, e.g. before cal and rm is executed. This is required because the mechanical space behind the hardware limit switches often is not sufficient to stop the axis under all velocities once they get actuated.

The travel speed is limited to a maximum of secvel as long as the axis is not calibrated and range measured ('cal'+ 'rm', refer to Remarks section below). The unit is always mm/s and does not depend on the 'dim' setting.

Setting secvel to higher values may be used at own risk.

The limitation affects all move and speed instructions as well as manual control e.g. by joystick.

Optional read resolution: As an option to read the parameter with higher precision, the number of required decimal places can be specified with the query "?secvel [0..16 decimal places]". If no precision is defined, the default resolution is 2 decimal places.

Remarks: Axes without any limit switches do not apply secvel at all. (E0 and EE switches must be disabled by 'swact' then.)

Axes with only one limit switch (E0/cal) release secvel after cal was executed. (EE/rm switch must be disabled by 'swact'.)

Axes with both limit switches (or when both limit switches are enabled by 'swact') require both 'cal' and 'rm' to release the secvel.

A time saving alternate to the **rm** move would be using the "virtual rm" (**vr**m) or having a factory defined axis length stored in the axis on request.

Response: Currently used secure velocity in [mm/s]
with default 2 or specified 0 - 16 fractional digits

Examples:

```
!secvel 100 100 100 => Set maximum possible secvel velocity for X Y Z
!secvel y 14.5      => Set maximum possible secvel velocity for Y to 14.5 mm/s
?secvel            => 10.00 10.00 10.00 (X Y Z response of a 3-axis controller)
?secvel x         => 10.00
?secvel -1        => 0 0 1 1 (read secvel active state = secvel active in Z+A)
?secvel x -1      => 0          (read secvel active state of X only = not active)

!secvel y 0.0001
?secvel y         => 0.00      (the default readout is not sufficient here)
?secvel y 5       => 0.00010   (read secvel with additional decimal places)

!secvel 0.123456
?secvel x         => 0.12
?secvel x 5       => 0.12346
?secvel 6         => 0.123456 10.000000 10.000000 10.000000
```

13.11. cur (Motor Current)

Syntax: !cur or ?cur
Parameter: x, y, z, a or none
0.03 to [maximum current]

Description: This instruction sets or reads the motor current. The maximum current is limited by hardware or additionally by factory settings (ETS) and may be checked using '**maxcur**' instruction.

If the specified motor current exceeds the maximum current, it is automatically limited to this maximum value and the error state **E5** is set (err --> 5).

Remarks: Please check the motor datasheet first in order not to damage the motor by overcurrent/overtemperature. If setting the motor current too low for the application the axis can lose steps. In open loop systems (no encoder feedback) this can cause loss of position; it mostly happens at very low velocities. It can lead to mechanical damage, because the position information is incorrect and with it the reference for the axis position limits. At least for open loop systems it is required to ensure the axis travels correctly under all required velocities and load situations.

If current reduction is active, the momentarily applied motor currents can be checked any time via the **iscur** instruction.

Response: Motor current in Ampere (e.g. 1.00)

Examples:
!cur 1.1 set X motor current to 1.1[A]
!cur 0.7 2.4 set motor current for X=0.7[A] and Y=2.4[A]
!cur z 0.3 set Z motor current to 0.3[A]
?cur read motor current of all axes
?cur x read motor current of X axis only

13.12. reduction (Motor Current Reduction Factor)

Syntax: !reduction or ?reduction

Parameter: x, y, z, a or none
0 to 1.00

Description: Motor current reduction factor when idle, used to reduce the dissipated heat from the motor.
When the axis is idle (stopped), the motor current (**cur**) is reduced by this factor.
Floating point numbers from 0 to 1.00 represent 0 to 100% of the motor current. Reduction is disabled when set to 1.

Recommendations:

1.0 = Disabled (default), best performance is achieved
0.7 = 70% as a good compromise, heat about 1/2 reduced
0.5 = 50% greatly reduced heat to 1/4
0.3 = 30% lowest recommended**
0 = 0% no torque, in open loop position might be lost

** below 30% (from reduction 0.29), the closed loop stops working (is prevented for not stalling the motor due to weak force). Also, when using a **motor brake**, the brake will be activated each time the reduction falls below 30%.

Remarks: The current reduction can be delayed by the '**curdelay**' instruction, so it won't apply always and immediately, But only when the axes are standing still for a longer time. Also, without adding a delay, reduction might have an impact on vector throughput, as it takes some extra time to increase the current ahead of each move or joystick deflection. The decrease and increase rate is 1% (0.01) per 160µs. When reduction is active and a move instruction or joystick deflection is executed, the axis current is first ramped up to 100%. This causes a response delay of e.g. 30%-->100% = 70*160µs = 11.2ms.

While reducing, the axis might slightly waggle, depending on mechanical load. This is also the case in **closed loop**: Reduction might cause slight position deviation after completing a move. And in case of ctr=1 "until target only", the deviation will remain. This behavior is improved from Firmware 1.75, but only if **curdelay** is set to zero (0).

In systems with encoders: Reducing the current to less than 0.3 (30%) will disable the permanent **closed loop** while reduction is active (axis is stopped + **curdelay** has expired).

To check for an active motor current reduction, the currently applied motor currents can be read via the **iscur** instruction.

As reduction reduces torque, it is not recommended for Z-axes.

Response: Reduction factor(s) [0.00 to 1.00]

Examples:

```
!reduction 0.7 0.7 1 Set reduction for X+Y to 70%, disable reduction in Z
!reduction x 0.5 Set X idle current reduction factor to 50% (0.5*cur)
?reduction Read idle current reduction factor of all axes
?reduction x Read idle current reduction factor of X axis
```

13.13. curdelay (Delay for Current Reduction)

Syntax: !curdelay or ?curdelay

Parameter: x, y, z, a or none
0 to 65000 [ms]

Description: At the end of each move, the axis enters idle state. If the motor current '**reduction**' is set to a value less than 1, this reduction will take effect after the curdelay time. Default=0.

Remarks: A delay might be necessary in cases of
- long time exposure (to avoid waggle)
- high vector throughput (to avoid reduction between the move)
- heat reduction when not operating (long, like a screensaver)

Response: Selected delay time for the current reduction in [ms]

Examples:

```
!curdelay 100 450 Set delay for motor current reduction X=100[ms] and Y=450[ms]
!curdelay z 15000 Set delay for motor current reduction Z=15 seconds
!curdelay 0 0 Set immediate reduction for X and Y axis
?curdelay Read motor current reduction delay of all axes
?curdelay x Read motor current reduction delay of X axis only
```

13.14. ecomove (EcoMove Current Level)

Syntax: !ecomove or ?ecomove

Parameter: x, y, z, a or none
0 to 70

Description: EcoMove reduces the motor current while the axis travels at constant velocity. It can be used to greatly reduce the dissipated heat of the motor.

Compared to '**reduction**', which reduces heat when the motor is idle, ecomove reduced heat when the motor is running.

The ecomove parameter works in a different way than reduction: Greater values = greater power saving, which means an eco level of 0 is 100% current and a level of 30 is 70% current.

0 = Full motor current (default)

70 = Maximum power saving level (low motor heating and force)

Remarks: The reduction is applied after finishing the acceleration and is increased to full current again before decelerating. So in applications that travel small steps, and therefore do not reach the constant velocity, ecomove has no effect. It is mostly intended and useful for long distances or slow speeds, where the constant velocity is reached.

Response: Ecomove level

```
Examples: !ecomove 0 0 0 0 (disable ecomove for all axes / 0%)
!ecomove x 25 (reduce X current by 25% when moving)
?ecomove (return all ecomove levels)
```

13.15. axis (Enable, Disable, Switch Off Axis)

Syntax: !axis or ?axis

Parameter: x, y, z, a or none
-1, 0, 1

Description: This instruction enables, disables and switches off axes. A disabled axis still powers the motor with its current, while a switched off axis loses its torque.

1 = axis enabled (default, move possible)
0 = axis disabled (amplifier and motor current remain on)
-1 = axis power stage off, no torque

Response: Axis enable state

Examples:

```
!axis 1 1 1 1    enable all axes
!axis 1 0 1 0    disable Y and A axis, enable X and Z
!axis y -1       switch off Y axis: power stage Y off
?axis x          read axis state of X axis only
?axis            read axis state of all axes
```

13.16. axisdir (Axis Direction)

Syntax: !axisdir or ?axisdir
Parameter: x, y, z, a or none
 0 or 1

Description: Travel direction of the axes.

0 = Normal axis direrction
1 = Reversed axis direrction

Remarks: Changing the axis direction should only be used once as a general setup of the hardware direction, and not be used during normal operation. After changing the axis direction and storing it in the TANGO by **save**, the TANGO should be resetted or at least the axis newly calibrated with cal.

The hardware limit switches CAL and RM will automatically be reassigned when switching the axis direction as well as the settings of swact, swpol, swtyp and **readsw**. Only **swin** will not adapt to the new E0/EE assignments, as it is hard-coded.

Only **in center referencing mode** (**caldir** ≥ 2), **swdir** must be changed also when changing the axisdir.

Closed loop will be deactivated when changing the direction and must be re-enabled by cal or reset/power-on.

If the axis is position corrected by factory (mapped), the axis direction is an essential part of the mapping process and must not be changed by the customer. If the direction of a position corrected axis is changed by the customer, the axis will no longer meet their specifications (position accuracy).

Response: Axis direction

Examples:

```
!axisdir 0 1 0 1    Set reversed travel directions to Y and A axis
!axisdir z 1       Set reversed travel direction for Z axis
?axisdir           Read axis direction of all axes
?axisdir x         Read axis direction of the X axis
```

Example for changing the axisdir **in a center referencing mode**:

The settings before the axisdir change are...

```
?caldir x         ==> 2     (a cernter referencing mode)
?axisdir x        ==> 0     (axisdir is normal)
?swdir x          ==> 0     (swdir is normal)
```

Then apply the required changes for center referencing...

```
!axisdir x 1       (set the axis direction change as usual, then...)
                   in center referencing mode, this also requires to:
!swdir x 1         (swamp the assignment of the limit switches E0-EE)
!caldir x 3        (and change the caldir direction towards the center)
```

13.17. motortable (Motor Correction Table)

Syntax: !motortable or ?motortable
Parameter: x, y, z, a or none
0 or number specified by factory

Description: Activates a pre-defined motor correction table, used to reduce resonances, vibration and open-loop positioning error. The motor must be measured for the specific application by factory. Then a table with unique number is added to the firmware and can be selected hereby. Using a wrong motortable will lead to increased vibrations and position error.

0 = No correction by pre-defined tables (default)

Response: Currently used motortable(s)

Examples:

```
!motortable 1 1 2 0    Select motortable 1 for X and Y, 2 for Z and none for A
!motortable x 0       Disable motor correction table for x
?motortable           Read the currently used tables for all axes
```

13.18. usteps (Microstep Resolution)

Syntax: !usteps or ?usteps
Parameter: 360 ... 1638400

Description: This instruction is used in conjunction with the unit '**dim 0**'. As '**!dim 0**' switches the axis unit to microsteps, the "usteps" instruction can be used to select the appropriate number of microsteps that make one revolution of the motor.

Setting usteps to 360 will result in e.g. "!mor 360" causing one revolution of the X-axis motor.

One value applies to all axes that have '**dim 0**' selected.

Remarks: The usteps instruction does not change the resolution of the motor. It only allows to select what number will cause one revolution when the axis is set to '**dim 0**' microsteps mode.

The '**dim 0**' is intended for backward-compatibility to existing software packages that might require positioning in microsteps instead of metric or imperial units.

Older software written for e.g. 40000 or 51200 microsteps per revolution can be used to control the TANGO controller.

As the usteps instruction does not change the physical resolution of the motor (typ. 819200 for a 200 steps motor), positioning instructions such as "moa", "mor", "go" can be executed with fractional values also, e.g. "!mor 12007.3". But the '**?pos**' instruction will always only return integer when in dim 0.

Response: Currently used **dim 0** microstepping resolution in [steps/rev]

Examples:

```
!usteps 51200        51200 is the count of microsteps for one revolution in dim 0.
?usteps              Read the microstep resolution
```

13.19. resolution (Position Number Format)

Syntax: !resolution or ?resolution
Parameter: 0, 1, ... 6

Description: This instruction sets the readout resolution of position returning instructions for the units **dim 1, 2, 9 and 10**. It affects the amount of returned fractional digits, as listed below. The number corresponds to resolution of mm. In case of μm dim units the fractional digits are 3 less. One value applies to all axes, the default is 4 (100 nm).

Value	Resolution dim 2+9	Resolution dim 1+10
0	= 1mm	0.1 μm
1	= 0.1mm	0.1 μm
2	= 0.01mm	0.1 μm
3	= 0.001mm	0.1 μm
4 (default)	= 0.0001mm	0.1 μm
5	= 0.00001mm	0.01 μm
6	= 0.000001mm	0.001 μm

Affected instructions are: ?pos, ?lim, ?maxpos, ?posclr, ?distance, ?twi, ?ctrs, ?ctrdiff, ?caliboffset, ?rmoffset, ?calpos, ?calzeropos, ?trigd, ?snsa, ?snsp.

The resolution should be set to an appropriate value to meet the applications requirements.

If e.g. the positioning is within 10 nanometers and/or the closed loop window "twi" is set below or has decimal places below the default 100nm resolution 4, it is important to set the resolution to 5 (=10nm).

Remarks: The resolution setting only affects the position readout, not the internal resolution of the TANGO. In addition, some instructions have an individual readout Parameter to increase their resolution when reading (e.g. "?twi 6"). If an individual resolution is available or not specified (e.g. "?twi" instead of "?twi 6"), the here configured resolution is applied.

Response: Responded fractional digits of the '**pos**' and other position returning instructions (0 to 6).

Examples:

```
!resolution 5      Set position read resolution to 10 nm (5 decimal places if mm)
                   e.g. "?pos x" returns 0.00000 in dim 2+9 and 0.00 in dim 1+10.
?resolution        Read the fractional digits resolution for position values

!dim 9
!resolution 4      (set resolution to the default, 100nm resolution)
?pos x             => 12.3457
?twi x             => 0.0001
?twi x 6           => 0.000050

!resolution 6      (set 1nm resolution, "6 fractional digits below the mm")
?pos x             => 12.345678
?twi x             => 0.000050

!dim 1
?pos x             => 12345.678 (at resolution 6, when using  $\mu\text{m}$  dim)
```

13.20. backlash (Mechanical Backlash Compensation)

Syntax: `!backlash` or `?backlash`
Parameter: `x, y, z, a` or none
`-100.0 ... 100.0 [µm]`

Description: Compensates mechanical backlash of the individual axes. Unit is always micrometer [µm], independent from dim.

0 = Backlash compensation off

Remarks: Backlash compensation is not applied in **closed loop mode**. Backlash compensation does not affect the axis performance. Backlash compensation is also applied in HDI mode, e.g. when using the joystick. Due to compensation the manual control is greatly improved when using high magnifications.

Backlash Info: Mechanical backlash becomes visible when traveling to the same position from both directions, forward and backward. The backlash value is half the amount of this deviation.

Response: Axis backlash in micrometer [µm]

Examples:

<code>!backlash 12.7 21.3 0</code>	Set backlash for X to 12.7µm, Y=21.3µm and Z=none
<code>!backlash x 0</code>	Disable backlash compensation for X
<code>?backlash</code>	Read the backlash compensation value of all axes
<code>?backlash z</code>	Read the backlash compensation value of Z axis only

13.21. blsmooth (Backlash Smoothing)

Syntax: `!blsmooth` or `?blsmooth`
Parameter: `x, y, z, a` or none
`0, 1` or `2`

Availability: 2nd generation TANGOs (e.g. Desktop HE) from Firmware 1.74.

Description: Softens the impact of the backlash compensation. Only applies to open loop axes (no encoders) with assigned **backlash** compensation value. Activating blsmooth could avoid shaking that is introduced by the backlash compensation. Backlash-shaking can occur on the first move when changing the travel direction and might become visible with stop&go scanning applications. The backlash usually causes twice the acceleration/velocity of the axis while traveling out of the backlash distance (usually a few micrometers). Blsmooth stretches the backlash compensation over a move (moa, mor, m, moe) to reduce the acceleration or speed increase. It is applied internally and lowers the impact by a factor of 1:1 until 1:32.

0 = blsmooth off (default)
1 = stretch the backlash within the acceleration ramp
2 = stretch the backlash up to half the travel distance max.

Response: Blsmooth mode of the axis or axes.

Examples:

<code>!blsmooth 1 1</code>	Set backlash smoothing to 1 for X+Y axis
<code>?blsmooth z</code>	Read the backlash smoothing mode of the Z-axis

13.22. precmode (Precision Move Mode)

Syntax: !precmode or ?precmode

Parameter: x, y, z, a or none
0, 1, 2, 3 or 4, 5, 6

Availability: 2nd generation TANGOs (e.g. Desktop HE) from Firmware 1.77.

Description: Set the Precision Move mode (default 0 = OFF).
The Precision Move can be used to eliminate backlash or stick-slip effects of an axis by always approaching the target position from one direction or always by precdist.
- It applies to move instructions moa, mor, m, moc, mol, moe
- It works in open loop and closed loop
- It works independent from the backlash compensation

The approaching distance is set by "**!precdist**".
The sign of the precdist value defines the approaching direction of the Precision Move (positive or negative).

0 = precision move off (default)
1 = precision move when traveling in opposite direction
2 = precision move when traveling in opposite direction or longer than precdist
3 = precision move always, any move approaches by precdist
4,5,6 = like 1,2,3, but with 1/8 acceleration to prevent shake

Remarks: A useful **precdist** must be set.

Response: Precision Move mode of the axis or axes.

Examples:

!precmode 3 3 Set the Precision Move mode for X+Y to 3
?precmode z Read the Precision Move mode of the Z-axis

13.23. precdist (Precision Move Distance)

Syntax: !precdist or ?precdist

Parameter: x, y, z, a or none
-4mm ... 0 ... +4mm (unit depends on **dim**)

Availability: 2nd generation TANGOs (e.g. Desktop HE) from Firmware 1.77.

Description: Set the Precision Move distance for the selected **precmode**.
Move instructions approach the target position under certain situations (precmode 1,2,4,5) or always (precmode 3,6) from the here specified distance (=value) and direction (=sign).

The 'precdist' approaching distance is used to eliminate backlash effects or to overcome stick-slip effects of an axis.
The sign of the precdist value defines the approaching direction of the Precision Move (positive or negative).

Response: Precision Move distance of the axis or axes according to the selected **dim**, decimal places according to resolution or as optionally specified with the ?precdist instruction.

Examples:

!precdist 0.005 0.005 0.002 Set the distance for X,Y to 5 and Z to 2 μ m
?precdist z ==> 0.0020 Read the distance of Z
?precdist z 6 ==> 0.002000 Read the distance of Z with 6 digits (\rightarrow 1nm)

13.24. lock (Select Parameters to Lock)

Syntax: ?lock or !lock
Parameter: 0 to 15, 0 or 1

Description: Select write protection for TANGO parameters (lock state).
Either bitwise: !lock [bit number] [0 or 1]
or multi bits : !lock [bit field of 0s and 1s]
After selecting the parameters to lock, these have to be
applied to the desired axes by '**lockaxis**'.

Response: Specified lock bit state or entire lock bit field, LSB first.
The bit positions represent the following parameters:

Bit Nr.	Parameter
0:	Pitch
1:	Gear
2:	Cur
3:	MotorSteps
4:	SwPol
5:	SwTyp
6:	SwDir
7:	EncType,EncTTL
8:	EncPeriod
9:	AxisDir
10:	MotorTable
11:	BackLash
12:	Anglecorr
13:	CalLrnPos
14:	CalibOffset
15:	RmOffset

Example: !lock 111 => Set lock bits 0 1 and 2, leave others unaffected
 !lock 2 0 => Clear lock condition for parameter 2 (=current)
 !lock 0 1 => Set lock bit for parameter 0 (pitch)
 ?lock => Read lock bit field (e.g. "0000000000000000")
 ?lock 5 => Read lock bit #5 state

13.25. lockaxis (Apply the Parameter Lock to Axes)

Syntax: ?lockaxis or !lockaxis
Parameter: x, y, z, a or none

Description: Apply the parameter lock, selected by the '**lock**' instruction,
to the specified axes. If the '**lock**' lockbits or lockaxis are
zero, nothing will be locked.

Response: Axes to which the lock bits are currently applied.

Example: !lockaxis y 1 => Apply lock bits to Y axis
 !lockaxis 1 1 => Apply lock bits to X and Y axis
 ?lockaxis x => Read if lock bits are applied to the X axis
 ?lockaxis => Read all axes (returns e.g. "1 1 0 0")

13.26. lockstate (Read all internal Lock States)

Syntax: ?lockstate

Parameter: x, y, z, a or none

Description: Set/read the internal parameter write protection (lock) state caused by the ETS (factory) and user lock+lockaxis settings. The bit positions represent the following parameters:

Bit Nr.	Parameter
0:	Pitch
1:	Gear
2:	Cur
3:	MotorSteps
4:	SwPol
5:	SwTyp
6:	SwDir
7:	EncTTL, EncType
8:	EncPeriod
9:	AxisDir
10:	MotorTable
11:	BackLash
12:	Anglecorr
13:	CalLrnPos
14:	CalibOffset
15:	RmOffset
16:	CalDir
17:	EncRes, EncForm
18:	PosShift
19:	RefDir
20:	EncDir

Response: Lock state as ASCII string of 16 or more bits of 0s and 1s, length depending on firmware version (max. 32), LSB first

Example: ?lockstate => Read lock state of all axes
?lockstate x => Lock state of X axis e.g. "1100000000000000"

13.27. stout (Select Status Signal Output)

Syntax: !stout or ?stout

Parameter: 0 ... 4 or 5

Description: Makes the state of the TANGO Status LED available to the optional AUX I/O connector:

- 0 = AUX I/O not used, Status-LED only (default)
- 1 = AUX I/O Pin 5 (TAKT_OUT) *not always supported*
- 2 = AUX I/O Pin 6 (VR_OUT)
- 3 = AUX I/O Pin 7 (SHÜTTER_OUT)
- 4 = AUX I/O Pin 8 (TRIGGER_OUT)
- 5 = PLED Connector (Onboard) *TANGO Desktop HE only*

Remarks: To turn off the original TANGO Status LED(s), the '**noled**' instruction may be used.

Response: Selected status output mode 0 to 5

Example: !stout 0 => Only use TANGO Status LED (default)
?stout => Read status output mode

13.28. noled (Force Status LED Off)

Syntax: !noled or ?noled
Parameter: 0 or 1

Description: Permanently force off the TANGO Status LED.
Forcing the LED off may be required in low light applications where no external light source is wanted.

0 = Normal operation, Status LED on (default)
1 = Status LED permanently off

Remarks: Forcing the TANGO Status LED(s) off only affects the TANGO Status LED(s). It does not affect the optional status output signal that can be selected by '**stout**'.

Response: Status LED mode

Example: !noled 1 => Force Status-LED permanently off
 !noled 0 => Status-LED normal operation (default)
 ?noled => Read status output mode (returns 0 or 1)

13.29. updelay (Power Up Delay)

Syntax: !updelay or ?updelay
Parameter: -5000 to 5000

Description: Delay time of the TANGO controller on power up in [ms].

This parameter is meant for fixing problems of TANGO PCI/PCI-E card versions with external power supply or long PCI reset times of the computer mainboard.

Applications: a) Master-Slave Power Switch for the external power supply
 The Status LED would then blink due to error 29, and this can be fixed by a longer wait. Which is usually no problem because the TANGO will still be booted faster than Windows.

In this case:

Use negative delay values to wait for valid motor voltage. The TANGO will boot as soon as the voltage is present and only wait the maximum time if the power is not delivered.

b) No communication to the PCI / PCI-E TANGO due to long mainboard reset time.

In this case:

Use positive values to wait a fixed time (e.g. when the mainboard generates a very long reset signal, it causes the PCI/PCI-E card to start as a Desktop version. So the virtual PCI COM port is not accessible.)

Positive values: The controller waits for the specified time.

Negative values: The controller waits for valid motor voltage for a maximum of this time or shorter.

Response: Power up delay time in [ms]

Example: !updelay -2000 => Wait max. 2s for valid motor voltage level
 !updelay 2500 => Wait 2.5s extra on power up
 ?updelay => Read the power up delay, e.g. default -1000

13.30. configexpwr (Configure External Power Required)

Syntax: `!configexpwr` or `?configexpwr`

Parameter: 0 or 1

Availability: Only with the 2nd generation TANGO PCI-E from Firmware 1.77.

Description: Option to only switch on the motor amplifiers when an external power supply is available.

This could be required or desired if e.g. the internal PC 12V supply is too weak to drive the motor currents, or one wants to ensure that the external power (and possibly a higher than 12V voltage due to required motor speed, CAN module etc.) is present.

However, when `configexpwr` is set, an external power supply higher than the internal PC 12V must be present or the amplifiers switch off (err 29).

The default setting is 0 (disabled).

Remarks: Depending on the external supply, a longer (negative) **updelay** could be required to ensure the voltage becomes present at power-up without causing an error 29.

Response: 0 or 1

Example: `!configexpwr 1` => Enable the external power required option
`?configexpwr` => Read the state

14. Limit Switch Instructions (Hardware and Software)

The axis limits are usually set by executing **cal** and **rm**. They can also be specified or later be narrowed by the **lim** instruction. There is an option to set circular (round) limits via **clim**, e.g. for petri dishes or wafers.

If limits should not be set at cal and rm, this can be configured by **nosetlimit**.

If limits should be ignored, this can be set by **limctr**.

The **limmode**, only available with the latest TANGO controller family, can be used to specify a behavior when the target position of a move is outside a limit.

Swtyp and **swpol** configure the electrical switching characteristic of a limit switch. Each switch can be configured individually.

Swact can be used to disable a switch, e.g. in case the switch is not present as it often is the case in focusing axes (Z). If the switch is disabled by **swact=0**, A rm (or cal) instruction is not executed to a disabled switch and the **secvel** limit might be released even after cal (e.g., if the rm switch is set disabled).

Swdir can be used to swap the assignment of the upper and lower switch per axis. It is not necessary if the axis direction is changed by **axisdir**. Then, the TANGO automatically exchanges the assignment. **Swdir** is only required if there is a wrong wiring in the axis where the E0 and EE switches are soldered to the wrong side / wrong pin of the motor connector.

Readsw can be used to read or poll the actuation state of the limit switches (1=actuated).

Swin is similar to **readsw**. It can be used to read the logic level of the limit switch inputs. It is a bit faster in case of polling and it offers using not required limit switch pins as digital 5V inputs, e.g. to read a state or button via unused switch wires through the motor cable.

Statuslimit shows the limit's state: If cal or rm was already executed or if a limit was modified by the **!lim** instruction.

Calst is similar to **statuslimit**, but easier to read. It only contains the cal+rm state.

The calibration state affects if the **secvel** velocity limit is applied or not. To find out if the **secvel** is currently applied or not, use **"?secvel -1"**.

14.1. lim (Software Limits)

Syntax: !lim or ?lim
Parameter: x, y, z, a (or none <- not recommended)
+-maximum position range (unit depends on 'dim')

Description: This instruction sets or reads the software position limits. Software limits can be used to narrow the positioning range of axes, limiting all move instructions and manual control. The software limits must be within the maximum positioning range as set by 'cal', 'rm' (or 'vrm') or, when none of the calibration routines are used, the maximum position range of the axes (e.g. +-2.6 meters). Setting the software limits outside of these limitations will not extend the positioning range and the axes still will stop at those maximum limits. Setting the software limits do not remove the **sevel** velocity limitations. Therefore 'cal', 'rm' or 'vrm' are required. The upper and lower software limits must be sent together in a single "!lim" instruction. The unit depends on 'dim' setting.

Remarks: It is recommended to read the limits axis by axis ('?lim x' etc.), because the '?lim' instruction for all axes has a formatting error of sending additional ',' and [CR] after the X-axis values. If **Extended Mode** is enabled (extmode = 1), the '?lim' instruction returns the limits as a correctly formatted string -> refer to the example below. 2nd generation TANGOs like TANGO Desktop HE do not have this wrong behavior, even in extmode 0.

By default (**nosetlimit** = 0), the soft limits are overwritten by the 'cal', 'rm' and 'vrm' instructions. Which (re-)set the soft limits to the mechanical limit switch positions.
-> For setting own software limits, use the '!lim' instruction after 'cal' or 'cal'+ 'rm' (or 'cal'+ 'vrm') was executed.

If the specified limit range is set below or above the current axis position, it is only possible to travel towards this limit range, not away from it.
Further, if both limits are set to the same position, it is only possible to travel there (or stay there).

From Firmware 1.78 it is possible to recall saved limit positions. It is described in: "**lim (To Save and Recall Software Limits)**"

Response: Currently used software limits [lower] [upper]

Examples:

```
!lim -2000 2000 -2000 2000 0 50    set the software limits for X, Y and Z axes
!lim 0 200 20 80                  set the software limits for X and Y only
!lim z 0 315                       set the software limits for Z to 0 ... 315
!lim z 45.37                       set the lower software limit of Z to 45.37
?lim y                             read upper and lower software limits of Y

?lim                               read all upper and lower software limits
                                only recommended in extmode=1, as shown:
```

?lim response example for 3 axes, without and with **extmode** enabled:

```
--> extmode=0: -2600 2600, [CR]-2600 2600, -800 800[CR] (mimic a faulty behavior)
--> extmode=1: -2600 2600 -2600 2600 -800 800[CR]      (also all 2nd gen. TANGOs)
```

14.2. lim (To Save and Recall Software Limits)

Syntax: !`lim` or ?`lim`
Parameter: `x`, `y`, `z`, `a` or none
 1 -1 or 0 -1 or 1

Availability: From TANGO Firmware 1.78.

Description: Additional function of "`lim`", to store limits positions in the TANGO and recall them when required.
 Usually, it makes no sense to have soft limits activated after power on or reset, because the origin (`cal`) position is unknown. This is the reason why limits are not kept. But there are cases, where stored limits can be recalled if required.

The new functionality does not interfere with existing applications, as the required parameter values are not legal for the `lim` instruction (upper limit below the lower limit).

The principle is that you set limits by "`!lim`" as usual. When sending a "`save`" instruction afterwards, only the limits that were set by "`lim`" before are stored. After save, they can be recalled. If "`lim`" is not used before a save or save is not executed yet, the saved limits remain untouched.

```
!lim z -10 20 (set a limit for Z)
save          (save this limit)

!lim  1 -1 recall the saved limit values for all axes
!lim z 1 -1 recall the saved limit values for the Z-axis

!lim  0 -1 reset all  limits to ±maxpos (max travel range)
!lim z 0 -1 reset the Z-limits to ±maxpos (max travel range)
           The saved limits will also be resetted if "save"
           is sent afterwards.

?lim  1      read the currently saved limits
?lim z 1 -1  read the currently saved limit for Z
```

Example 1:

```
!lim z -0.1 24.8 (set the limits for Z)
!save           (only the limits that were set by "!lim" are saved, here: Z)
!reset         (reset isn't required, save already takes the new saved limits)

?lim z        ==> -2600.0000 2600.0000
!lim z 1 -1   (the saved Z-limits are restored and applied)
?lim z        ==> -0.1 24.8
!lim z -9.999 9.999 (overwrite the Z-limit)
?lim z        ==> -9.9990 9.9990
!lim z 1 -1   (again apply the saved Z-limit)
?lim z        ==> -0.1000 24.8000
```

Example 2:

```
!lim z 0 -1   (reset the limits of Z)
?lim z        ==> -2600.0000 2600.0000 (the Z-limits are resetted here, but..)
?lim z 1      ==> -0.1000 24.8000     (the saved Z-limit is not resetted yet)
!save        (execute "save" to overwrite the saved Z-limit by the resetted limit)
?lim z 1      ==> -2600.0000 2600.0000 (now also the saved Z-limit is resetted)
A reset is not required, the save instruction already takes the new limits or
resetted limits to the saved limit positions.
```

14.3. clim (Circular Software Limit)

Syntax: !clim or ?clim
Parameter: center position x,y and radius
 or only radius
 (units depend on '**dim**')

Description: This instruction provides circular movement range limitations. The limit can be specified either with XY center position or just with the radius. Then the current XY axis positions will be used as center. The units depend on '**dim**', the x and y axes must have the same dim setting.

*!clim 0 disables circular limits
?clim 1 queries the state (active=1, inactive=0)*

*!clim [centerPosX] [CenterPosY] [Radius] or
!clim [Radius] set the circular limit.*

Applications: E.g. round shaped samples like Petri dishes, wafers, etc. to avoid collisions with the rim or external components or to stay within a round inspection area.

Response: Circular limits [X] [Y] [radius] or active state [0,1]

Examples:
!clim 50 70 10 Set circular limit of radius 10 at center position X=50,Y=70
!clim 9.5 Set circular limit of radius 9.5 around the current position
!clim 0 Disable circular limits
?clim Read circular limit positions and radius (cenx ceny radius)
?clim 1 Query if circular limits are enabled (1) or disabled (0)

14.4. limctr (Enable or Disable Limit Control)

Syntax: !limctr or ?limctr
Parameter: x, y, z, a or none
0 or 1

Description: This instruction enables or disables the limit control or returns the current state of it.

0 = disabled
1 = enabled (default from power on)

Attention: Setting limctr to 0 can cause mechanical damage to the axis! If limit controls are disabled, the controller ignores any limits set by **cal**, **rm** or **lim**. Actuating the limit switches is still recognized (as long as they are not deactivated by the **swact** instruction).

Remarks: Some TANGO controllers or Firmware versions have limit control enabled by default from power on and do not allow storing the disabled state permanently by the save instruction.

Response: Limit control state

Example:
!limctr z 0 disable Z limit control, Z axis limits are ignored
!limctr 1 1 1 enable X, Y and Z limit control
?limctr a read limit control state of A axis only
?limctr read limit control state of all axes

14.5. nosetlimit (Do not set Limits by Cal/Rm)

Syntax: !nosetlimit or ?nosetlimit
Parameter: x, y, z, a or none
0 or 1

Description: Enables or disables setting of software limits (**lim**) by the calibration (**cal**) and range measure (**rm**) functions. The default is nosetlimit=0 which means that the software limits are set from !cal and !rm to the axes end-positions.

Response: 0 = set software limits to !cal and !rm positions (default)
1 = do not change software limits after !cal or !rm

Examples:
!nosetlimit 1 1 X and Y axis do not take software limits after !cal and !rm
!nosetlimit y 1 Y axis is does not set software limits of !cal and !rm move
?nosetlimit read nosetlimit state of all axes
?nosetlimit a read nosetlimit state of A axis only

14.6. limmode (Limit Monitoring Mode)

Syntax: !limmode or ?limmode

Parameter: 0, 1 or 2

Availability: 2nd generation TANGOs (e.g. Desktop HE).

Description: Behavior when exceeding a position limit (?lim). In case an automatic move moa,mor,m,moc,mol,moe target position exceeds a position limit, it is truncated to the limit position without notice. Only '?pos' can be used to check if the desired Position was reached. This is the default (0).

Limmode offers two additional ways how to handle a move that exceeds a position limit: mode 1 and 2.

Mode 0 is the regular behavior of a TANGO controller. The axis travel will be limited without notice.

Mode 1 will not execute moves and vector moves, if at least one axis would exceed its position limit. The @@@ reply will contain an 'E 'for the not moved axes (discarded move). In addition, error state 32 will be set (?err).

Mode 2 maintains the regular behavior, but an 'L' will be sent in the @@@ response for a limited axis. No error state is set: In mode 2, the behavior is like default mode 0, except the 'L' return.

One parameter applies to all axes.

Response: 0, 1 or 2

Examples: !limmode 0 Set limit mode to default
?limmode => 0 Read limit mode

```
!limmode 1  
!lim x 0 50  
!moa 75 10 => EE@@.  
?err       => 32  
?pos x     => 0.0000
```

```
!limmode 2  
!lim x 0 50  
!moa 75 10 => L@@@.  
?err       => 0  
?pos x     => 50.0000
```

```
!limmode 0  
!lim x 0 50  
!moa 75 10 => @@@@.  
?err       => 0  
?pos x     => 50.0000
```

14.7. swtyp (Type of Limit Switch)

Syntax: !swtyp or ?swtyp

Parameter: x, y, z or a (specifying an axis is recommended)
0 or 1, 0 or 1, 0 or 1

Description: Set or read the limit switch type, per axis only.
Assigns a pull-up or pull-down resistor to the switch input.
The sequence is always:

```
!swtyp [SWITCH_E0] [SWITCH_REF**] [SWITCH_EE]
```

0 = PNP: applies a pull-down resistor to the switch input

1 = NPN: applies a pull-up resistor (default)

Remarks: ** The REF switch is not used by the TANGO controller.

It is recommended to set each axis individually by using the axis parameter x, y, z or a.

Using no axis parameter will apply the the values to all axes!

Please note that the E0 and EE switches are reassigned by a change of the **axisdir** instruction.

A complete setup for a limit switch is: swtyp, swpol, swact.

Response: Currently selected limit switch type

Examples:

```
!swtyp z 0 0 1 set Z axis limit switches E0=PNP, REF(don't care), EE=NPN
```

```
?swtyp y read E0, EE switch types of Y axis (returns e.g. 1 0 1)
```

```
?swtyp not recommended,
```

```
in extmode=0 returns e.g. 1 1 11 1 11 1 1
```

```
in extmode=1 returns e.g. 1 1 1 1 1 1 1 1 1
```

```
!swtyp 1 0 1 set limit switches to NPN type for all axes at once  
(not recommended)
```

14.8. swpol (Polarity of Limit Switch)

Syntax: !swpol or ?swpol

Parameter: x, y, z or a (specifying an axis is recommended)
0 or 1, 0 or 1, 0 or 1

Description: Set or read the active polarity of the limit switches, per axis only. The sequence is always:

```
!swpol [SWITCH_E0] [SWITCH_REF**] [SWITCH_EE]
```

0 = switch has active low signal

1 = switch has active high signal

Remarks: ** The REF switch is not used by the TANGO controller.

It is recommended to set each axis individually by using the axis parameter x, y, z or a.

Using no axis parameter will apply the the values to all axes!

Please note that the E0 and EE switches are reassigned by a change of the **axisdir** instruction.

The **swin** instruction is not affected by the polarity setting, as it returns the TTL logic level and not the actuation state.

A complete setup for a limit switch is: swtyp, swpol, swact.

Response: Polarity of the limit switches

Examples:

```
!swpol y 1 1 1 set polarity of Y limit switches (E0 REF EE) to active high
```

```
!swpol z 0 0 0 set polarity of Y limit switches (E0 REF EE) to active low
```

```
?swpol x read limit switch polarity of the X axis (returns e.g. 0 0 0)
```

```
!swpol 1 0 1 set polarity of limit switches for all axes at once  
(not recommended)
```

14.9. swact (Enable or Disable Limit Switches)

Syntax: !swact or ?swact

Parameter: x, y, z or a (specifying an axis is recommended)
0 or 1, 0 or 1, 0 or 1

Description: Enable or disable the limit switches, per axis only.
The sequence is always:

```
!swact [SWITCH_E0] [SWITCH_REF**] [SWITCH_EE]
```

0 = switch is disabled (actuation state is ignored)
1 = switch is enabled

Remarks: ** The REF switch is not used by the TANGO controller.

It is recommended to set each axis individually by using the axis parameter x, y, z or a.
Using no axis parameter will apply the the values to all axes!

Please note that the E0 and EE switches are reassigned by a change of the **axisdir** instruction.

The **swin** instruction is not affected and can still be used to read the TTL logic level of the inputs.

A complete setup for a limit switch is: swtyp, swpol, swact.

Secvel velocity: If all switches of an axis are set to inactive, **secvel** will not be applied (no velocity limitation at all). If EE (**rm**) switch is set to inactive, the **secvel** limitation will be released after the cal. If both switches E0+EE are activated, **cal+rm** must be executed in order to release the secure velocity.

Response: Limit switch enable states [E0] [REF] [EE] (e.g. 1 0 1)

Examples:

```
!swact z 1 0 1 set Z limit switches E0=enabled REF=disabled EE=enabled
```

```
?swact a read limit switches enable state of A axis only (e.g. 1 0 1)
```

```
!swact 1 0 1 enable cal and rm limit switches for all axes at once  
(not recommended)
```



14.10. swdir (Swap Assignment of Cal and Rm Switch)

Syntax: !swdir or ?swdir
Parameter: x, y, z, a or none
0 or 1

Description: Swap the cal (E0) and rm (EE) switch assignment.

0 = switches are not swapped (default)
1 = switches are swapped

In opposite to the '**axisdir**' instruction, which swaps motor direction and limit switch assignment, swdir only swaps the limit switches E0<->EE without changing the axis direction. This may become necessary due to wiring of the axis and depends on the axis hardware. It is independent of axisdir, which works with and without a swapped swdir.

Attention: **Swapping the switches to the wrong assignment may result in mechanical damage!**
swdir should only be used to compensate false wiring of the stage limit switches or in case of center referencing mode, where when changing the axisdir, also swdir must be changed.

Response: Current state of endswith assignment(s)

Examples:

```
!swdir 1 1 0 Swap E0<->EE switch assignment in X and Y, not in Z
!swdir x 1 Swap E0<->EE switch assignment in X (E0 switch is now EE etc.)
?swdir Read switch assignment of all axes
?swdir z Read switch assignment of Z axis only
```

14.11. readsw (Read Status of Limit Switches)

Syntax: ?readsw or readsw

Parameter: x,y,z,a or none

Description: Readsw returns the actuation state of the limit switches. The switch assignment (E0 and EE) depends on **axisdir** and is reassigned automatically when the axis direction is reversed. Disabled switches (**swact** set to 0) are read as inactive (0).

0 = limit switch is currently not actuated or is disabled
1 = limit switch is currently actuated (axis is in switch)

The switch state is only valid when **swtyp**, **swpol** are set correctly and the switch is activated by **swact**.

Sequence of the returned 12 ASCII characters is:

Axis: X Y Z A X Y Z A X Y Z A
Switch: [E0][E0][E0][E0][Ref][Ref][Ref][Ref][EE][EE][EE][EE]

E0 = lower limit switch (!cal instruction)

Ref = Reference switch (only in center-ref mode, else 0)

EE = upper limit switch (!rm instruction)

Remarks: From Firmware 1.73 it is possible to read single axis states. Order when reading a single axis is: [E0] [EE]

Center Reference: If axes are set to center reference mode (caldir \geq 3, one limit switch in the center of the axis), the corresponding [Ref] character is used to indicate the center switch state. The [E0] and [EE] characters then will only be used if the center reference configuration also provides optional limit switches. Usually those are not present and [E0] and [EE] then are 0, using readsw with axis specifier is useless.

Response: Actuation state of limit switches as 12 character ASCII string or, when called with axis, the [E0] and [EE] state of the axis

Examples: readsw => 000000001000 (read all actuation states)
readsw x => 0 1 (read actuation states of X-axis)

14.12. swin (Read Limit Switch Input Level)

Syntax: ?swin or swin
Parameter: none or 0...7

Description: This instruction reads the limit switch signal directly. The response is a string of 8 characters, either 0 or 1. Optionally, a single switch can be read.

0 = limit switch input signal is TTL low
1 = limit switch input signal is TTL high

Unlike the '**readsw**' instruction, swin reflects the TTL input levels of the motor connector limit switch inputs. Even disabled switches are represented with their current TTL input signal level. Swin is not affected by the swpol polarity, axisdir and swdir setting (does not change the E0<->EE switches or invert the logic levels).

END1 are the switches for X, END2 = Y, END3 = Z, END4 = A.

Sequence of the 8 ASCII characters is: Motor connector signals
[END10] [END1END] [END20] [END2END] [END30] [END4END] [END40] [END4END]
(0 1 2 3 4 5 6 7 index)

Response: Limit switch input TTL level as 1 or 8 ASCII character(s) 0/1

Examples: swin => 11111111 (read all 8 limit switch signal levels)
swin 1 => 1 (read motor connector signal END1END)

14.13. statuslimit (Cal / Rm / Lim Status)

Syntax: ?statuslimit or statuslimit

Parameter: none

Description: Read the status of the soft- and hardware limits concerning the **cal**, **rm** and **lim** instructions. It can be used to check if the axes were already calibrated (cal) or range measured (rm) and if a software limit was set by the **!lim** instruction.

The status information is arranged in 4 groups.

The ASCII character string positions are:

```
0 ... 3: Group 1 => cal state of axes x,y,z,a: '-' or 'A'
4 ... 7: Group 2 => rm state of axes x,y,z,a: '-' or 'D'
8 ... 11: Group 3 => lower lim state of x,y,z,a: '-' or 'L'
12 ... 15: Group 4 => upper lim state of x,y,z,a: '-' or 'L'
```

The characters represent the state with 4 possible characters:

- => cal or rm not performed, limit not set/modified since power on

A => axis is calibrated (!cal), lower limit was set by cal (e.g.=0)

D => axis is range measured (!rm), and upper limit was set by rm

L => software limit has been modified by the !lim instruction

STRING: "-----" up to max. "AAAADDDLLLLLLLLL"

AXIS : xyzaxyzaxyzaxyza

LIMIT : CAL RM LIM-LIM+

Remarks: For a more simple cal+rm information, refer to '**calst**'.
For a more detailed state information '**sta**' can be used.

Response: ASCII string of 16 characters

Example: Assume '?statuslimit' returns the string "AA-A---D-LL-L--L"

This means in detail:

```
[ 0] A -> X-axis is calibrated
[ 1] A -> Y-axis is calibrated
[ 2] - -> Z-axis is not calibrated
[ 3] A -> A-axis is calibrated
[ 4] - -> X-axis is not range measured
[ 5] - -> Y-axis is not range measured
[ 6] - -> Z-axis is not range measured
[ 7] D -> A-axis is range measured
[ 8] - -> X-axis lower software limit is not modified
[ 9] L -> Y-axis lower software limit is modified by !lim
[10] L -> Z-axis lower software limit is modified by !lim
[11] - -> A-axis lower software limit is not modified
[12] L -> X-axis upper software limit is modified by !lim
[13] - -> Y-axis upper software limit is not modified
[14] - -> Z-axis upper software limit is not modified
[15] L -> A-axis upper software limit is modified by !lim
```

15. Calibration and Range Measure Instructions

After power on or **reset** of the TANGO, a calibration (instruction **!cal**), followed by a range measure (instruction **!rm**), should be executed to set the axis origin, the hardware position limits, releasing the '**secvel**' velocity limit and enabling the encoders and position correction.

The only exception are axes with absolute encoders, which do not require cal/rm.

Range Measure options

If the axis length is known from ETS axlen, range measure (rm) is not required. Also, to save time, a virtual range measure (**vrn**) can be executed instead of traveling to the RM/EE limit switch with rm. Caution must be taken, as vrn does not check if the there specified axis length is correct.

However, the rm instruction can be executed to measure the true, full available axis length and get a more accurate MR encoder calibration.

Shifting the limits and zero position

The cal/rm instructions set the axis position limits close to the limit switch positions. If a position limit must be further away from the limit switch or must be adjusted to a certain position, **!caliboffset** and **!rmoffset** can be used to specify individual distances. Then, the zero position and limits are set at those positions. As those position offsets (distances) are only used at the end of a cal or rm instruction, the rmooffset is not applied with **!vrn** or with the ETS-specified axis length when only using cal.

Timeouts

Long axes and/or slow velocities may exceed the default calibration timeout of 40 seconds. Therefore, the timeout can be changed by the **caltimeout** instruction.

Modes

Please also refer to the optional **extmode** enhancements (here: calvel velocities instead of vel) and **calmode**, **caldir** or **encref/callrn** options for calibration.

Encoders with reference mark

It is possible to calibrate to the reference mark of an encoder. With **calmode** set to 0 and **encref** to 1, the cal instruction continues with **encrefvel** out of the limit switch until the encoder reference mark is reached.

Before Firmware 1.74, the axis origin (true zero and start of the position correction) remained at the cal switch position. A simple **!pos 0** instruction was executed at the precise reference mark position.

From Firmware 1.74, the true axis position is set to zero at the reference mark position. Similar to **caliboffset**, the **posshift** value can be used to travel away from the reference mark position (**caliboffset** is only applied after releasing the limit switch, before and not after traveling to the reference mark).

Also, from Firmware 1.74 it is possible to use the reference mark **to calibrate** (cal) **without a limit switch**. Therefore, disable the CAL/E0 switch (**!swact**).

This option is only recommended for turntable applications, where the axis will not run into a mechanical limit. Depending on **extmode**, vel or calvel is used to find the reference mark instead of **encrefvel**, as it replaces the cal instruction and therefore might travel a longer distance to it. The search direction is mainly forward (plus some wiggling), but can be forced with **modulomodes 2** and **3**. In turntable applications without limit switches and only a reference mark, e.g. filter wheels or objective revolvers, both limit switches should be disabled. The **secvel** limit then is never applied, but it is still used for the reference find velocity (useful in **extmode=0**, where vel is used for cal and not calvel).

States

Checking **statuslimit**, **calst** or **sta** tells if a **!cal** or **!rm** was performed or not.

15.1. cal (Perform Calibration to lower Limit Switch)

Syntax: !cal or cal

Parameter: x, y, z, a or none (or a bitmask 1...15 from Firmware ≥ 1.73)

Description: This instruction moves either the specified or all axes towards lower positions until the limit switch E0 is detected. By default, cal defines the reference position of the axis and enables encoders, closed loop and axis correction.

From Firmware 1.73 it is possible to easily calibrate any combination of axes by using axis bits (1=X,2=Y,4=Z,8=A). But a certain sequence/order of the axes can not be specified.

Depending on the '**calmode**' setting, this position is used as origin (position 0) and, if '**nosetlimit**' = 0 (default), also as the new lower software limit.

If the E0 switch is disabled (**swact**), or the axis is disabled (**axis**) cal of the axis will be skipped (returns '@', not 'A'). From Firmware 1.74, there is an exception for cal with E0 disabled: The cal instruction can use the encoder reference. Refer to information provided under **Calibration and Range Measure Instructions**.

The CAL velocities depend on the setting of '**extmode**':

Extmode=0 (mostly the default setting):

- travels towards switch with the axis velocity **vel**, (secvel)
- travels out of switch with '**calbspeed**'

Extmode=1:

- travels towards switch with '**calvel**' parameter 1
- travels out of switch with '**calvel**' parameter 2

The movement stops slightly after traveling out of the switch. If required, this gap can be increased by '**caliboffset**'.

Remarks: After cal, the calibration state can be read by '**statuslimit**', '**calst**' or '**sta**'.

If cal failed, 2nd generation TANGOs from firmware 1.77 offer requesting the '**calresult**' (0=no info, 1=success, >1=error).

For higher accuracy, cal can use an encoder reference mark, encoder period or motor period: Refer to '**encref**' options.

Response: Depends on **autostatus** settings.

For the default **autostatus mode 1**, a reply is as follows:

Like **!moa**, **!mor** etc., but instead of an '@' it returns an

'A' after a successful calibration or
'E' if an error occurred (cal was unsuccessful)
'T' if a timeout occurred (cal was unsuccessful)
'-' the axis is not present

Examples: cal calibrate all enabled axes => "AAA-."
cal y start calibration of the Y axis => "@A@-."
cal 5 calibrate the X and Z axis (from Firmware 1.73)
Firmware before 1.73 would require disabling axes:
"!axis 1 0 1" / "!cal" / "!axis 1 1 1" => "A@A-."

15.2. rm (Perform Range Measure to upper Limit Switch)

Syntax: !rm or rm

Parameter: x, y, z, a or none (or a bitmask 1...15 from Firmware ≥ 1.73)

Description: This instruction moves either the specified or all axes towards higher positions until the limitswitch EE is detected.

From Firmware 1.73 it is possible to easily range measure any combination of axes by using axis bits (1=X,2=Y,4=Z,8=A).

If the EE switch is disabled (**swact**), or the axis is disabled (**axis**) cal of the axis will be skipped (returns '@', not 'A').

The behavior of RM depends on the setting of **'extmode'**:

Extmode=0 (mostly the default setting):

- travels towards switch with the axis velocity **'vel'**, **secvel**
- travels out of switch with **'calbspeed'**

Extmode=1:

- travels towards switch with **'rmvel'** parameter 1
- travels out of switch with **'rmvel'** parameter 2

The movement stops slightly after traveling out of the switch. If required, this gap can be increased by **'rmoffset'**.

if **'nosetlimit'** is set to 0 (default), rm also sets the rm-position as the new upper software limit.

Options: If the axis travel distance is known or should be limited, a "virtual range measure" (**vr**m) can be used where the axis does not travel but directly sets the upper hardware limit at the specified position(s). Or, if a new cal calibration is executed, the rm distance can be kept by the **keeprm**, in order to save time required for the rm.

Remarks: After rm, the range measure state can be read by **'statuslimit'**, **'calst'** or **'sta'**.

Response: Depends on **autostatus** settings. For the default **autostatus mode 1**, a reply is as follows:

Like **!moa, !mor** etc., but instead of an '@' it returns an

'D' after a successful rangemeasure or
'E' if an error occurred (rm was unsuccessful)
'T' if a timeout occurred (rm was unsuccessful)
'-' if the axis is not present (e.g. 4th axis)

Examples: rm range measure all enabled axes => "DDD-."
rm y start range measure of the Y axis => "@D@-."
rm 5 range measure the X and Z axis (from Firmware 1.73)
(To do this with older firmware, it requires
a sequence with disabling of axes:
"!axis 1 0 1" / "!rm" / "!axis 1 1 1" => "D@D-."
or sending "rm x" and "rm z" after each other)

15.3. vrm (Virtual Range Measure)

Syntax: !vrm or vrm

Parameter: x, y, z, a or none
Axis length(s) in user **dim**

Description: Can replace the need of an **rm** move, by just defining the axis length without axis travel (time saving).

Same as with the **rm** instruction the

- **secvel** is released
- corresponding **statuslimit** 'D' entry is set
- hardware limit is set (the internal axis end position)

Vrm requires that **!cal** was performed on the axis. **
Vrm does not return any **autostatus** reply (like the @@@-),
It returns immediately.

Warning: Specifying a wrong axis length can cause mechanical damage.

Remarks: Check **?err** response or **statuslimit** for 'D' entries to make sure the vrm position parameter(s) were accepted and executed.

** If axes are not **calibrated**, the vrm function causes error 2.

Axes with MR encoders (nanoScale) should perform a true **rm** for high accuracy calibration of the encoder signals.

Vrm can also be used before executing an **rm** move in order to travel fast (without **secvel** limitation) near the **rm** limit switch → then **rm** can be executed (caution: velocity might be high now) to get the real maximum hardware travel range and/or to allow the above mentioned encoder calibration which is performed during a **rm** (refer to Sequence example3).

Response: None

Examples:
vrm 75 50 virtual range measure (define axis lengths of X=75, Y=50)
vrm y 150 virtual range measure for Y axis (define Y=150)

Sequence example1:
cal x
cal y
cal z
?statuslimit => "AAA-----"
vrm 300 300 20
?statuslimit => "AAA-DDD-----"

Sequence example2:
cal x
cal y
!moa 10 10
!pos 0 0 (the lower limit is now at position -10 -10)
vrm 300 300 (the upper limit is set to 290 290)

Sequence example3:
cal x (calibrate the X axis)
!vel 40 (set X velocity to e.g. 40mm/s)
vrm 300 (virtually set X **rm** for e.g. a 300mm axis)
!moa 300 (move to end of X travel range without **secvel**)
!vel 10 (slow down for executing **rm**)
!rm x (perform true hardware **rm** from here =time saving)

15.4. calmode (Closed Loop and Calibration Behavior)

Syntax: !calmode or ?calmode

Parameter: x, y, z, a or none
0, 1, 2, 3, 4 or 5

Description: The calmode reads or sets the calibration and closed loop behavior at power-up. Typically, mode 0 or 2 is selected.

The calmode is a general behavior that should be selected once - because switching during operation, especially between mode 1 or 3 against other modes causes unpredictable behavior if the TANGO is not restarted afterwards (off/on or Reset).

- 0 : **cal** instruction sets the zero position (**default**) and the Closed loop is enabled after cal
- 1 : the zero position is set at power-up and remains, a cal instruction doesn't set or modify the zero position* Closed loop is enabled from power-up
- 2 : **cal** instruction sets the zero position as mode 0, but the Closed loop is enabled from power-up
This is especially useful or required, if the axis is driven by e.g. a bowden wire or Uhing® drive.
Depending on the encperiod size, the axis will more or less wiggle for activating closed loop (MR: about 1mm).
- 3 : the axis is used only to readout a measuring system.
Requirements are:
 - the encoder must be a TTL or 1Vpp type, no analog MR
 - encmask must be enabled
 - encpos must be enabled (for reading ?pos)
 - encdir must be set to the required counting direction
 - axis amplifier should be switched off (e.g. !axis z -1)
(it might be possible to use the motor independently, but at least a cal will set both, the motor and encoder positions to zero. The pos at encpos=0 belongs to the motor, the pos at encpos=1 to the encoder)
- 4 : performs an automatic **cal** move after power-up.
Caution! The axes will move without notice immediately after reset or after switching on the TANGO controller. It is not possible to communicate with the TANGO while the cal move is running. It is also not possible to stop the axes by sending an abort instruction. Only the STOP input or the PSE input can stop the axis. If no axis is connected, the TANGO will respond only after the caltimeout (typ. 60 or 40 seconds) has expired.

Mode 4 is useful in standalone applications (without a PC), where the zero position must be set automatically At power up and/or the position correction of the axis.

The cal is executed axis by axis, starting with X.

The TANGO will not respond to any instruction while the cal moves are executed. If no axis is connected, the cal will consume all the caltimeout of the corresponding axis/axes.

The Status LED indicates a running cal at power-up: The LED goes shortly dark about every 2.5 seconds while cal is running.

The cal is executed at the vel or secvel velocity, depending on which is set to the lowest velocity. In extmode=1, the calvel will be used instead of vel.

The cal will not release **secvel**, the secvel velocity limit will only be released if an axlen is specified in the ETS. Else a **rm** instruction would be required afterwards.

5 : restores the position at power-up (in open loop only). Except the restore, the behavior is like in calmode 0.

The TANGO will remember the axis position(s) at which the power was switched off and restore it at power-up. Work can continue at the state and position where the TANGO was switched off before.

If cal/rm was executed, the TANGO will restore those too, release the **secvel** limits and apply position correction. But if wanted, cal/rm can be repeated any time.

If own "!lim" position limits were stored by !lim+save, 1st gen. TANGOs from firmware 1.79 and 2nd gen. TANGOs from firmware 1.80 will also restore the saved limits. Older TANGO firmware will not restore those limits.

Only open loop is supported, closed loop or encoders will not be restored. Soft limits (set by !lim) are also not restored.

Caution! The position relies on the last known position where the TANGO was switched off. If the axes are displaced while the TANGO is switched off, the position information is invalid, and so might be the axis limits. Which in worst case can cause damage. So please ensure that the axes remain at their positions during power off when using the calmode 5 functionality.

If the TANGO is switched off while the axes are traveling, the restored positions might not be correct.

Remarks:

For activating the closed loop, **'encmask'** of the corresponding axes must be set to 1. If encmask is not set or no encoder is present (signal amplitude very low), the calmode only affects the axis zero position behavior.

The activation of encoders in calmode 1 and 2 causes a slight axis travel (wiggle). For MR encoders this is about 1mm, while 1Vpp and TTL systems travel a much shorter distance. From TANGO firmware 1.80 and higher, the initial wiggle direction can be changed if required, e.g. with Z-axes to avoid damage of the optics (that the first move is "up"). The instruction is **'encsearchdir'**.

Calmode 0 is the default setting for most applications, calmode 2 is similar but often useful for axes with encoders, to have closed loop active from power on without requiring a cal for it.



- * In calmode 1, the position offset between the CAL switch and the axis position (which remains from the power-up position) can be read out by using '?calzeropos', after a **cal** move was executed.

If the closed loop is set to disabled (ctr = 0), calmode 2 or 1 will still activate the encoder, if present, so the user can use their position with encpos, or decide to enable the closed loop (ctr) later on. MR encoder signals get calibrated.

Response: Calmode of the axes (0...5)

Examples:

```
!calmode 0 0 0 Calmode behavior of axes X,Y,Z set to default operation
!calmode z 2 Set Z axis to enter closed loop instantly after power-up
?calmode Read calmode of all axes
?calmode y Read calmode of Y axis only
```

15.5. calrequired (Calibration Required)

Syntax: !calrequired or ?calrequired
Parameter: x, y, z, a or none
0 or 1

Description: The calibration required mode offers a mechanism to prevent axis travel until the **!cal** instruction is executed. It can be used to e.g. prevent collisions until the axis is in a known position.

0 = The axis can travel even without !cal (default)
1 = The axis is halted until a !cal is executed

Remarks: An internal calrequired state can be applied automatically in certain caldir modes and absolute encoder settings. Then, the calrequired setting is internally overwritten by it. The internal cal required state set by this instruction or certain other operation modes can be read in an '**?sta**' bit.

Response: Calrequired setting of the axes (0 or 1)

Examples:

```
!calrequired 0 0 0      No cal required to enable X,Y,Z axis move (default)
!calrequired z 1       Cal required to enable axis move in Z
?calrequired           Read calrequired mode of all axes
?calrequired y        Read calrequired mode of Y axis only
```

15.6. caltimeout (Calibration Timeout)

Syntax: !caltimeout or ?caltimeout
Parameter: x, y, z, a or none
1 to 120 (seconds), from firmware 1.77 up to 600 seconds

Description: This instruction specifies the timeout for calibration (**cal**) and range measure (**rm**) instructions. It can be set for each axis individually, depending on axis length and velocities. The default value is 60 seconds for X and Y, 40 for Z and A.

From firmware 1.77 it is also possible to read the remaining time until the timeout expires during a cal or rm routine or the time that remained after cal or rm has completed. It can be used to adjust caltimeout values for a certain application.

Remarks: For long axes (over 350mm) the default timeout of 40...60s becomes insufficient and must be increased, as the typical cal, rm travel velocity is 10mm/s and the cal, rm routines mpower some additional time around the limit switch.

Response: Calibration+RangeMeasure timeout in seconds

Examples:

```
!caltimeout 60 60 60   set the cal/rm timeout for X,Y,Z to 60 seconds
!caltimeout x 40       set the cal/rm timeout for X to 40 seconds
?caltimeout           read timeout of all axes
?caltimeout z         read timeout of Z axis only
?caltimeout -1        read the remaining times      (from firmware 1.77)
?caltimeout x -1      read the remaining time of X (from firmware 1.77)
```

15.7. caliboffset (Calibration Offset)

Syntax: !caliboffset or ?caliboffset

Parameter: x, y, z, a or none
Position (-0.1 ... 100mm, unit depends on 'dim')

Description: This instruction specifies a calibration position offset. When executing a 'cal' instruction, the axis travels this extra distance away from the limit switch E0 and sets the origin (axis zero position) and the lower pos limit there. The unit depends on the current 'dim' settings. Valid position range is -0.1 to 100mm equivalent. The default value is 0. Negative values can be used to lower the safety gap of 0.1mm, which is always internally added for more space to the switch so that the hardware limit switch will never be activated.

Remarks: When calibrating to a reference mark (**encref=1**), a possible caliboffset will be applied as usual after releasing the CAL switch. And from there, the reference signal search starts. This might be an unwanted behavior, as it could skip the ref signal. To specify a distance for setting the zero position away from the **ref signal** position, don't use caliboffset. From Firmware 1.74, the **posshift** setting can be used for it.

If the cal position is learned for higher repeatability, a change of caliboffset requires a new cal learn procedure.

Response: Position offset which is traveled out of the CAL/E0 switch

Examples:

```
!caliboffset 10 5.5 0.1 set the calibration offset for X, Y and Z axis
!caliboffset x 0.05    set the calibration offset for X axis to 0.05
?caliboffset          read the calibration offset of all axes
?caliboffset y        read the calibration offset of Y axis only
```

15.8. rmosffset (Range Measure Position Offset)

Syntax: !rmosffset or ?rmosffset

Parameter: x, y, z, a or none
Position (-0.1 ... 100mm, unit depends on 'dim')

Description: Similar to caliboffset, this instruction specifies an extra position offset for the 'rm' instruction. The axis travels this extra distance away from the upper limit switch EE and sets upper limit position there. The unit depends on the current 'dim' settings. Valid position range is -0.1 to 100mm equivalent. The default value is 0. Negative values can be used to lower the safety gap of 0.1mm which is added by default to allow more space to the switch.

Response: Position offset which is traveled out of the RM/EE switch

Examples:

```
!rmosffset 1 1 1    set the range measure offset to 1 (mm at dim 2 or 9) for X,Y,Z
!rmosffset z 0.1    set the range measure offset to 0.1 (mm at dim 2 or 9) for Z
?rmosffset          read range measure position offset of all axes
?rmosffset z        read range measure position offset of Z axis only
```

15.9. keeprm (Keep Range Measure Information)

Syntax: !keeprm or ?keeprm

Parameter: x, y, z, a or none
0 or 1

Availability: From TANGO Firmware 1.74.

Description: Sets or reads the keeprm enable state.
Keeprm remembers the axis length after a cal+rm sequence and restores it, when a cal is executed. This way, no new **rm** is required, and secvel will not be applied.
The default setting is disabled (0).

Response: Current keeprm setting(s), 0 or 1

Examples:

```
?keeprm => 0 0 0 read keeprm enable state of all axes
?keeprm x => 0 read keeprm enable state of X axis only
!keeprm y 1 enable keeprm for Y-axis
!keeprm 1 1 0 enable keeprm for X&Y-axis, disable for Z
```

15.10. caldir (Calibration Direction)

Syntax: !caldir or ?caldir
Parameter: x, y, z, a or none
0, 1, ... 7

Availability: From TANGO Firmware 1.73 and higher.

Description: Behavior of the calibration '**cal**' function.
Mode 0 is the default mode, where the axis calibrates towards the lower limit switch E0. Mode 1 is currently not supported, while modes 2 to 7 are used to configure different center reference modes:

- Three behaviors are available, where the cal instruction stops at the limit switch, or where it travels to the axis center or where it travels to the lower end (pos 0) of the axis. Mode 2+3, 4+5, 6+7.
- Those 3 behaviors are available for the two possible configurations of the center reference, if the signal is "active at higher" or "active at lower" positions. When changing the axisdir, this "higher/lower" setting must also be changed 2↔3, 4↔5, 6↔7 (and the swdir).

Caldir Modes are:

0 = Default behavior, cal calibrates to lower limit (E0)
(1 = NOT SUPPORTED! Cal calibrates positive to upper limit)

2 = Center Reference, signal active at lower positions
3 = Center Reference, signal active at upper positions
→ cal stops directly at the reference position

4 = Center Reference, signal active at lower positions
5 = Center Reference, signal active at upper positions
→ cal stops at the exact center position

6 = Center Reference, signal active at lower positions
7 = Center Reference, signal active at upper positions
→ cal stops at the lower position of the axis, pos 0

Remarks: Caldir cannot be changed while CAL or RM is running.

**Center Reference:

Center Reference requires additional configurations which must be set by factory. Wrong configuration will lead to damage of the axis.
In Center Reference mode, an E0 signal is expected that masks about the upper or lower half of the travel range.

For Center Reference, the position shift from the axis zero position to the position where the center ref cal function completes must be specified by **posshift** or in the ETS.

From Firmware 1.74, the caldir mode for Center Reference can be changed by the user, even if it is set by factory: The user can change the behavior between 2, 4 and 6 or between 3, 5 and 7 with "!caldir".

Response: Current behavior of the cal function (0 to 7).



Examples:

```
?caldir          read caldir of all axes
?caldir x        read caldir of X axis only
!caldir y 0      set Y caldir to default calibration behavior (lower limit)
!caldir z 1      CALDIR 1 NOT SUPPORTED! (here: calibrate Z to upper limit)
!caldir 2 2 0    set X and Y to Center Referencing mode, Z to default
```

15.11. calbspeed (Calibration Speed for Retraction)

Syntax: !calbspeed or ?calbspeed
Parameter: x, y, z, a or -1
0.1 to 8000 [*0.01 revolutions/s]

Description: **(Available in EXTMODE=0 only, else use calvel/rmvel)**
Set or read the cal/rm calibration speed which is used for traveling out of the limit switches E0 and EE.

Remarks: RESTRICTIONS APPLY DUE TO BACKWARDCOMPATIBILITY. See examples. Setting the calbspeed without specifying an axis will set all axes to this one value. It is recommended to access axes individually. Refer to examples below. Calbspeed is only available in **extmode=0**. For improved behavior and flexibility please refer to the **calvel**, **rmvel** instructions, which become available with **extmode=1** and replace the calbspeed and vel.

Response: Currently used calibration back speed [in 1/100 motor rev/s]

Examples:
!calbspeed 50 50 *ILLEGAL INSTRUCTION!*
!calbspeed 15 *COMPATIBILITY RESTRICTIONS! 0.15 [revolutions/s] for all axes!*
?calbspeed *COMPATIBILITY RESTRICTIONS! Returns one parameter!*

?calbspeed -1 read the the limit switch retraction speed of all axes
!calbspeed z 20 set the limit switch retraction speed for Z only (recommended)
?calbspeed x read the limit switch retraction speed for X (recommended)

15.12. calrefspeed (Reference Signal Calibration Speed)

Syntax: !calrefspeed or ?calrefspeed
Parameter: x, y, z, a or -1
0.1 to 8000 [*0.01 revolution/s]

Description: Reference mark calibration speed. This speed is used when searching the encoder reference mark. The default value is 32 (0.32 rev/s). There is only one value for all axes. (Formerly intended for the reference switch.)

Remarks: RESTRICTIONS APPLY DUE TO BACKWARDCOMPATIBILITY. See examples. **It is recommended to use the new instruction 'encrefvel'.**

Response: Currently used calrefspeed [in 1/100 motor rev/s]

Examples:
!calrefspeed 5 5 *ILLEGAL INSTRUCTION!*
!calrefspeed 15 *COMPATIBILITY RESTRICTIONS! 0.15 [revolutions/s] for all axes!*
?calrefspeed *COMPATIBILITY RESTRICTIONS! Returns one parameter!*

?calrefspeed -1 read the the referencing speed of all axes
!calrefspeed z 20 set the referencing speed for Z only (recommended)
?calrefspeed x read the referencing speed for X (recommended)

15.13. calpos (Calibration Position read from Encoder)

Syntax: `!calpos` or `?calpos`
Parameter: `x, y, z, a` or none
none or 0 (0 ... 100mm possible, unit depends on **dim**)

Availability: Only for axes with encoders.

Description: Used in combination with an encoder to measure calibration position accuracy (repeatability of the origin). During calibration the encoder signal period, where the limit switch E0 was released and the origin (pos=0) was set, is stored. This position value within an encoder period can be read with `?calpos`. The position may also be set to another value (usually to 0). The unit depends on the setting of '**dim**'. Valid range is 0 to 100mm equivalent.

Remarks: In case there is no encoder, or the encoder period is smaller than the deviation range, `calposmot` possibly can be used.

Response: A position within the range of one encoder signal period

Examples:
`?calpos y` read calibration position of Y axis (e.g. returns 0.0000)
`?calpos` read calibration position of all axes
`!calpos 0 0 0` set calibration positions to zero (X, Y and Z)
`!calpos y 0` set calibration position of Y axis to zero

15.14. calposmot (Calibration Position read from Motor)

Syntax: `!calposmot` or `?calposmot`
Parameter: `x, y, z, a` or none
none or 0 (0 ... 16383 possible)

Availability: From TANGO Firmware 1.73.

Description: Like `calpos`, `calposmot` is used to measure calibration position accuracy (repeatability of the origin), but without the need of an encoder or in case of open loop applications. During calibration the motor current signal period, where the limit switch E0 was released and the origin (pos=0) was set, is stored. This position value within an motor current sine period can be read with `?calposmot`. The position may also be set to another value (usually to 0).

Remarks: The motor current signal period range depends on lead screw pitch, gear setting and the motorsteps. It can be calculated as $(\text{pitch}/\text{gear}) * (4/\text{motorsteps})$ [mm]
E.g. a 4mm pitch and 200 steps 1.8° motor have 80µm period.

Response: A position within the range of one motor current signal period
0 ... 16383

Examples:
`?calposmot y` read cal position of Y axis motor period (e.g. returns 5193)
`?calposmot` read cal position of all axes
`!calposmot 0 0 0` set cal positions to zero (X, Y and Z)
`!calposmot y 0` set cal position of Y axis to zero

15.15. calabspos (Calibration Position from Absolute Encoder)

Syntax: !calabspos or ?calabspos

Parameter: x, y, z, a or none

Availability: 2nd generation TANGOs (e.g. Desktop HE), with absolute encoder.

Description: Returns the absolute position of the encoder where the cal routine has completed (and usually defines the zero position). If the axis provides a lower limit switch (E0/CAL), the '!cal' instruction can be used to once determine the posshift value for zero alignment (posshift = -calabspos).

Remarks: If no E0/Cal switch is available, the absolute position can be determined by manually shifting the axis to the lowest position (maintain some 1/10mm gap to the mechanical limit) and read the local '?abspos' there.

Response: RAW position of the absolute encoder at the cal position (0). The unit depends on **dim**.

Examples:

```
cal 3           => AA@@.
Calabspos      => 438.1338 35.7331 0 0
calabspos y    => 35.7331
```

15.16. calzeropos (Position at CAL)

Syntax: ?calzeropos

Parameter: x, y, z, a or none

Description: In **calmode 1**, the axis position is not set to zero by the **cal** instruction. In order to determine the "zero" position after **cal**, calzeropos can be read.

Remarks: CalModes other than 1 (0,2) set the position to zero after executing cal. So the returned position is zero in this cases.

Response: Position at which the **cal** instruction completed. The unit depends on **dim**.

Examples:

Assuming calmode set to "!calmode 2 1 0 0" and cal already executed on all axes:

```
?calzeropos y    -153.1433
?calzeropos      0.0000 -153.1433 0.0000 0.0000
?calzeropos x    0.0000
```

Assuming all axes traveled +10 mm after the cal instruction:

```
?calzeropos y    -153.1433    (this axis is in calmode 1)
?pos y           -143.1433    => -143.1433 - (-153.1433) = 10.0000

?calzeropos x    0.0000    (this axis is in calmode 2)
?pos x           10.0000    => 10.0000 - 0.0000 = 10.0000

?calzeropos z    0.0000    (this axis is in calmode 0)
?pos z           10.0000    => 10.0000 - 0.0000 = 10.0000
```

15.17. calvel (Calibration Velocities for CAL Instruction)

Syntax: !calvel or ?calvel

Parameter: x, y, z or a, read is also possible without axis parameter
one or two velocities (depending on dim)

Description: **This instruction is accessible in EXTMODE=1 only.**
If **extmode=1**, this instruction replaces the **calbspeed**
and **vel** parameters for the calibration (!cal) instruction:

Parameter 1 : speed towards cal limit switch (find)
Parameter 2 : speed out of cal limit switch (slow release)

Velocity unit: [motor rev/s] for dim = 0 ... 8
[mm/s] for dim = 9 and 10

The travel speed towards the limit switch should not be faster than 10mm/s to prevent mechanical damage (axis must be able to stop within a short distance after a limit switch event).
The travel speed out of the limit switch should be low for achieving high position accuracy, e.g. 0.5mm/s

Remarks: calvel can be set per axis only, with x,y,z,a specified
When extmode=0 (default), the calvel towards the limit switch is set/specified by the !vel instruction.

Response: Two velocities (towards and out of limit switch) per axis

Examples:

```
!calvel x 10 0.5 cal in X travels towards E0 limit switch at a velocity of 10  
                  and out of the limit switch at a velocity of 0.5  
!calvel x 10     set the velocity towards the switch only  
?calvel         read cal velocities of all axes (xvel1 xvel2 yvel1 yvel2 etc.)  
?calvel y      read cal velocities of Y axis only (e.g. returns 10.000 0.500)  
!calvel 10 0.5 NOT SUPPORTED! The set (!calvel) instruction is per axis only
```

15.18. rmvel (Range Measure Velocities for RM Instruction)

Syntax: !rmvel or ?rmvel
Parameter: x, y, z or a, read is also possible without axis parameter
one or two velocities (depending on dim)

Description: **This instruction is accessible in EXTMODE=1 only.**
If **extmode=1**, this instruction replaces the **calbspeed** and **vel** parameters for the range measure (!rm) instruction:

Parameter 1 : speed towards rm limit switch (find)
Parameter 2 : speed out of rm limit switch (slow release)

Velocity unit: [motor rev/s] for dim = 0 ... 8
[mm/s] for dim = 9 and 10

The travel speed towards the limit switch should not be faster than 10mm/s to prevent mechanical damage (axis must be able to stop within a short distance after a limit switch event).
The travel speed out of the limit switch should be low for achieving high position accuracy, e.g. 0.5mm/s

Remarks: rmvel can be set per axis only, with x,y,z,a specified
When extmode=0 (default) the rmvel is taken from vel.

Response: Two velocities (towards and out of limit switch) per axis

Examples:
!rmvel x 10 0.5 in X, rm travels towards EE at a velocity of 10, out with 0.5
!rmvel x 10 set the velocity towards the switch only
?rmvel read cal velocities of all axes (xvel1 xvel2 yvel1 yvel2 etc.)
?rmvel y read cal velocities of Y axis only (e.g. returns 10.000 0.500)
!rmvel 10 0.5 NOT SUPPORTED! The set (!rmvel) instruction is per axis only

15.19. autopitch (Measure Pitch after CAL Instruction)

Syntax: !autopitch or ?autopitch
Parameter: x, y, z, a or none
0 or 1

Description: Measures and sets the axis pitch each time when executing a cal instruction. Used for drives with unknown pitch values.

Remarks: Only works if encoders are present.
Not recommended for drives with known pitch, e.g. lead screw.
TANGO Desktop HE does not save the autopatch setting anymore.

Response: Autopitch enabled (1) or disabled (0, default)

Examples:
!autopitch 1 1 0 Measure and readjust pitch after each cal instruction X and Y
!autopitch y 1 Measure and readjust pitch after each cal instruction in Y
?autopitch read mpower u setting of all axes
?autopitch x read mpower u setting of X axis

Pitch adjusting sequence for X: !autopitch x 1
!cal x
[wait for "A@@" reply]
!autopitch x 0
?pitch x
!save

15.20. refdir (Direction for Searching the Reference Switch)

Syntax: !refdir or ?refdir
Parameter: x, y, z, a or none
0 or 1

Description: DUMMY INSTRUCTION. The additional REF switch is not supported by TANGO controllers. Only CAL and RM switches are used.

Specifies or reads the direction in which the !ref instruction searches the [REF] reference switch. The !ref instruction is not available.

Response: 0 = search in negative direction (default)
1 = search in positive direction

Examples:
!refdir y 1 set the Y-axis reference switch search to positive direction
!refdir 1 1 0 set the reference switch search direction of X, Y and Z axis
?refdir read reference switch search directions of all axes
?refdir x read reference switch search direction of X axis only

15.21. posshift (Position Shift for Zero Alignment)

Syntax: !posshift or ?posshift
Parameter: x, y, z, a or none
position values (depending on dim within ± maxpos)

Availability: From TANGO Firmware 1.73 and higher.

Description: Position shift to align the zero position of the axis.
Used for
- Center Reference Modes **caldir** 2-7 for distance to zero.
- axes with absolute encoders, where the encoder position must be shifted to the axes zero position.
- an offset option for axes that CAL to a reference mark in **encref** mode 1 (as caliboffset does not apply there).

Remarks: Posshift must (or should) be stored in the ETS by factory. This internal posshift value here, if written to the TANGO, can only be used for **Center Reference Modes**. Then it defines the distance from 0 to the center reference, e.g. 37.9833mm (always a positive value) or for **Calibrating to a Reference Mark** (encref=1). But it is always recommended to write it to the ETS.

Absolute Encoders

In case of Absolute Encoders, it is mandatory to have the posshift in the ETS, so it is ensured being safely attached to the axis of the specific, individual measuring system. The value entered is the absolute position of the measuring system at the axis zero position.

Response: Shift position for Center Reference or Absolute Encoders.
The unit depends on '**dim**'.

Examples: !posshift 438.1338 35.7331 0 0
!posshift y 35.7331
?posshift => 438.1338 35.7331 0.0000 0.0000
?posshift x => 438.1338

16. Move Instructions

The move instructions cause the TANGO to move axes to certain positions, over a certain distance or to travel at a constant, specified velocity.

The instructions can be executed for individual or for several axes at once.

Positioning (*moa*, *mor*, *m*, *moc*, *moe*, *mol*) is based on the velocity (*vel*) and on the acceleration (*accel*, *accelfunc*) settings.

If executed for 2 or more axes at once, a vector move is started where the axes travel synchronously and reach their target at the same time. This vector move behavior can be changed by the *scanmode* setting.

Moa and *mor* are similar instructions. **Moa** travels based on absolute coordinates, defined by the axis origin or the user-defined **!pos**, while **mor** travels distances relative to the current position.

The **'m'** instruction can be used to achieve high vector throughput with little communication overhead (often combined with **autostatus=3**). The relative distances must be preset - either by the last **mor** or a **distance** instruction.

A special case of positioning is available with the **go** instruction. It does not move as a vector, here each axis travels at its own velocity and *accel* settings. Also, it only provides linear acceleration (*accelfunc* does not apply).

The advantage of the **go** instruction is that it can be overwritten at any time with no need to abort the currently executed move. It will smoothly change directions. Target applications are e.g. focusing via a slidebar or tracking a mouse cursor position or a touchscreen.

The third option for axis travel is a **speed** move. Here velocities are specified instead of positions. The addressed axes travel at those velocities until stopped, aborted or reaching a position limit. As with **go**, the speed instruction is also not executed as a vector and does not use the *accelfunc*. Speed requires the joystick to be enabled (**joy** and **joydir**).

Remarks on relative positioning:

Due to internal resolution, a sequence of many consecutive relative moves may lead to (minor) absolute position deviation. Executing an absolute move at times is recommended.

Also, if HDI is enabled, minor changes in position may occur due to the connected device (Joystick, ERGODRIVE). Which can also accumulate position error when only using relative moves. It is recommended to deactivate the HDI when using relative moves (by instructions **joy** or **joydir**).

Autostatus 1 reply after an automatic move has completed:

In default **autostatus=1**, there is an ASCII-reply when all moves have completed. It differs a bit from what **?statusaxis** returns (when polling the move state).

The auto reply is triggered when all move instructions or **cal**, **rm** have ended. The reply is also sent if an axis is still traveling due to a speed instruction. The information about the 4 axes in sequence XYZA and a terminating dot ".". A reply for a 4 axis TANGO might look like this: @@@@. Possible characters are:

'-' = this axis is not configured or available → e.g. @@--. For a 2 axis TANGO
'@' = this axis is at the desired position and idle
'M' = this axis is not idle (possibly still traveling due to speed instruction)
'A' = this axis has successfully completed a **cal** instruction (reply of **!cal**)
'D' = this axis has successfully completed a **rm** instruction (reply of **!rm**)
'S' = this axis was stopped by a hardware limit switch E0 or EE
'E' = this axis was stopped by an error, a stop signal, abort or in **limmode 1**
'L' = this axis move was cut by a position limit (in **limmode 2** only)

16.1. moa (Move Absolute)

Syntax:	!moa or moa
Parameter:	x, y, z, a or none position values within \pm maxpos
Description:	Move one or more axes to the specified position(s). The position unit depends on dim settings.
Response:	5 ASCII characters, representing axes 1-4 and terminating '.'. Example: "@@@-." Depends on autostatus settings, which per default is set to 1. Each axis responses a '@' after successfully completing the move, or e.g. an 'E' if an error occurred, 'S' being stopped by a limit switch. TANGO Desktop HE (in limmode 2) might also reply an 'L' when the target position was truncated by a software limit. For further information on possible response characters, please refer to move instructions , autostatus and statusaxis .
Examples:	
moa 10 0 20	axes X,Y,Z travel to the specified positions (vector move)
moa 10 0.5	axes X and Y travel to the specified positions (vector move)
moa x 10.2	X-axis travels to position (e.g. 10.2mm if dim=2)
moa 10.2	same as "moa x 10.2"
moa y 34.5	Y-axis travels to position (e.g. 34.5mm if dim=2)

16.2. mor (Move Relative)

Syntax:	!mor or mor
Parameter:	x, y, z, a or none distance values within \pm maxpos
Description:	Move one or more axes relative to the current position. The position unit depends on dim settings.
Response:	5 ASCII characters, representing axes 1-4 and terminating '.'. Example: "@@@-." Depends on autostatus settings, which per default is set to 1. Each axis responses a '@' after successfully completing the move, or e.g. an 'E' if an error occurred or an 'S' for being stopped by a limit switch. TANGO Desktop HE (in limmode 2) might also reply an 'L' when the target position was truncated by a software limit. For further information on possible response characters, please refer to move instructions , autostatus and statusaxis .
Examples:	
mor 10 0 -20	axes X,Y,Z travel the specified distances (vector move)
mor 10 0.5	axes X and Y travel the specified distances (vector move)
mor x 10.2	X-axis travels the specified distance (e.g. 10.2mm if dim=2)
mor 10.2	same as "mor x 10.2"
mor y -34.5	Y-axis travels e.g. (if dim=2) 34.5mm backwards

16.3. m (Move Relative Shortcut)

Syntax: !m or m
Parameter: none

Description: Similar to **mor**, the **m** command can be used to move one or more axes relative to their current position. It is useful to speed up communication especially for consecutive identical vectors. With the **m** command, the positions are defined by a preceding **distance** or **mor** command. **M** will move all enabled axes if their **distance** is not set to zero.

Response: 5 ASCII characters, representing axes 1-4 and terminating '. '
Example: "@@@-."
Depends on **autostatus** settings, which per default is set to 1. Each axis responses a '@' or 'J' after successfully completing the move, or e.g. an 'E' if an error occurred, 'S' for switch. For further information on possible response characters, please refer to **move instructions**, **autostatus** and **statusaxis**.

To maximize performance, **autostatus** mode 3 can be set, where the position reached response string consists of only a [CR] ([CR] = 0x0d hex, or '\r').

Example: Positioning sequence involving moa,mor,m

```
!moa 1 2 3 4      will move to 1 2 3 4
!mor 1 1 1 1      will move to 2 3 4 5      (mor sets distance)
m                will move to 3 4 5 6      m continues until:
!distance 1 2 0 0 (specify m distance)
m                will move to 4 6 5 6
m                will move to 5 8 5 6
m                will move to 6 10 5 6
m                will move to 7 12 5 6
.
.
.
```

16.4. distance (Distance for m)

Syntax: !distance or ?distance
Parameter: x, y, z, a or none
Distance (within ±maxpos)

Description: Sets the travel distance for '**m**' instructions.
The unit depends on the '**dim**' settings.

Remarks: The distance value is also set by each '**mor**' instruction or by a relative move of the '**moe**' instruction.

Distances must be defined for all axes, axes that shall not move have to be set to distance = 0.

Response: Currently used value for distance (unit depends on '**dim**')

Examples:

```
?distance          read distance values of all axes
?distance z        read distance value of Z axis only
!distance 10 20 0  set X and Y distance
!distance 1 2 0.5  set X, Y and Z distance
!distance y 20.2   set Y distance only, other axes keep their distance values
```

16.5. moc (Move to Center)

Syntax: !moc, moc or ?moc
Parameter: x, y, z, a or none (or a bitmask 1...15 from Firmware ≥ 1.73)

Description: The specified or all enabled axes travel to the center position between their lower and upper software limit. It is recommended to first execute the **!cal** and **!rm** instructions.

Remarks: From Firmware 1.73 it is possible to
- directly read the moc center position(s) by '?moc'
- execute !moc with a bitmask: specified axes XYZA= 1,2,4,8

Response: 5 ASCII characters, representing axes 1-4 and terminating '. '
Example: "@@@-." Depends on **autostatus** settings (default=1). Each axis responses an '@' after successfully completing the move, or e.g. an 'E' if an error occurred, 'S' for switch. For further information on possible response characters, please refer to **move instructions**, **autostatus** and **statusaxis**.

Examples:
moc all axes travel to their center position
moc y Y-axis travels to the center position
moc 5 X(1) and Z(4) travel to their center positions (Firmw. 1.73)
?moc x => 25.0000 read center position of the X-axis (Firmware 1.73 or higher)

16.6. mol (Move to LockPos)

Syntax: !mol or mol
Parameter: x, y, z, a or none

Description: The specified or all enabled axes travel to the transportlock position. This special move instruction may be used to position the microscope stage or axes to their transport position, where the fixation screw is inserted.

Requirements: 1) The axes must be calibrated (by **!cal**)
2) The lock position must be stored in the ETS or virtual ETS

Remarks: The factory defined lock positions can be read by **lockpos**. If the position value is greater 0, a lock position is available.

Response: 5 ASCII characters, representing axes 1-4 and terminating '. '
Example: "@@@-." Depends on **autostatus** settings, which per default is set to 1. Each axis responses a '@' or 'J' after successfully completing the move, or e.g. an 'E' if an error occurred, 'S' for switch. For further information on possible response characters, please refer to **move instructions**, **autostatus** and **statusaxis**.

Examples:
mol all axes travel to their transportlock position (if available)
mol y Y-axis travels to to the transportlock position (if available)

16.7. go (Go To Position)

Syntax: !go or go
Parameter: x, y, z, a or none
position values within \pm maxpos

Description: Intended for tracking a position that changes randomly while the axes are still traveling, e.g. by a mouse or touchscreen. Similar to 'moa', it executes a move to an absolute position. For non-interrupted positioning, 'moa' should always be used. The differences to a regular 'moa' instruction are:

- Go can be overwritten any time by another go position, even while traveling
- The velocity can be changed while traveling (**vel**)
- The move can be ended (at the normal acceleration) by sending a go instruction without position value, (or by setting vel=0 or **speed**=0)
"go" stops all axes, "go y" only the Y axis etc.
- Go is not a vector move, each axis travels at its own velocity (**vel**) and acceleration (**accel**)
- It only supports linear acceleration (no s-curve)
- It might introduce more shake or backlash than moa
- Positioning might take longer than moa (throughput)
- No "@@@" **autostatus** reply on completion (see Remarks)

The unit of the position values depends on **dim**.

Remarks: Use TANGO Firmware 1.68/1.60S3 from March 2017 or higher.
In order to check for a completed go move, please poll the **statusaxis** (short: **sa**) state, which should **not** be '**M**' then.
Snapshot Mode **snsn** 6 is ignored by the go instruction.
The go instruction does not work properly in **modulo modes**.

Response: None.

Examples:

```
go 10.7 14 axes X and Y travel to the specified positions (no vector)
go x 10.2 the X-axis travels to position 10.2 ([mm] assume dim=2)
go 10.2 same as "go x 10.2"
go 10.1 -0.5 0 axes X, Y, Z travel to the specified positions (no vector)
go (or !speed 0 0 0) stops the go instruction for X, Y and Z axis (using accel)
go z (or !speed z 0) stops the go instruction for Z axis only
go 10 100
go 2 11.5 => change in direction while axis is already traveling
```

Sequence examples:

```
!vel z 10
go z 100 => starts an absolute move in Z at a velocity of 10
!vel z 1 => changes the velocity of Z to 1 while still traveling
!vel z 0.1 => changes the velocity of Z to 1 while still traveling
go 0.5 5.2 100.15 => start absolute move for X, Y and Z axis
!vel y 40 => changes the velocity of Y to 40 while still traveling
!vel 20 15 40 => changes velocities of X, Y and Z while still traveling
go 10 100 => starts an absolute move in two axes (X, Y), now...
"go x" or "!vel x 0" or "!vel 0" will end the X move at the default acceleration
"go y" or "!vel y 0" will end the Y move at the default acceleration
"go" or "!vel 0 0" will end the two axis move
```

16.8. speed (Speed Move)

Syntax: !speed or ?speed

Parameter: x, y, z, a or none
+-100 [rev/s], or as [mm/s] in dim 9 and 10 only

Description: Lets axes travel (or motors spin) at the specified velocities. A speed move is stopped by setting the speed to zero, by abort (**a**) and when reaching a software- (**lim**) or hardware-limit. Speed uses the acceleration set by **accel** and only provides linear acceleration.

Remarks: **Joydir** must be enabled for the corresponding axes to allow execution of the speed instructions, while the **joy** setting doesn't affect speed. Alternatively the **sp** instruction can be used instead of speed, which does not depend on joydir.

For endless rotation please refer to **modulomode=1** or **!zero**.

Setting speed to zero also stops a running **go** instruction.

Unless **dim 9** or **10** is used, the unit of speed is always in motor revolutions per second.

Example: If dim is < 9 at a 4mm pitch, to achieve 1mm/s, the !speed must be set to 0.25

Response: Currently executed speed in [rev/s], or [mm/s] at dim=9+10 with default 3 or specified 0 - 16 fractional digits
Speed does not generate an **autostatus** reply.

Examples:

```
!speed 29.3 0.01 start speed move for X=29.3[rev/s] and Y=0.01[rev/s]
!speed 10 start speed move for X-axis to 10[revolutions/s]
!speed y 0.001 start speed move for Y-axis
!speed 0 0 0 0 stop speed move for all axes (or stops a go instruction)
!speed 0 stop speed move for X-axis (or stops a go instruction in X)
!speed z 0 stop speed move for Z-axis (or stops a go instruction in Z)
?speed read the currently executed speed of all axes
?speed z read the currently executed speed of Z-axis only, e.g. 0.000
?speed 5 read the currently executed speeds with 5 fractional digits
?speed z 6 read the currently executed Z speed with 6 fractional digits
```

16.9. sp (Speed Move)

Syntax: !sp, sp or ?sp

Parameter: x, y, z, a or none
+-100 [rev/s], or as [mm/s] in dim 9 and 10 only

Availability: All TANGO types from Firmware 1.75

Description: The same as the **speed** instruction, with improvements:
- operates independently of joydir setting
- does not require an '!' for setting the speed

Response: Currently executed speed in [rev/s], or [mm/s] at dim=9+10 with default 3 or specified 0 - 16 fractional digits

Examples:

```
sp 29.3 0.01 start speed move for X=29.3[rev/s] and Y=0.01[rev/s]
sp y 0 stop a speed move (or a !go instruction) on the Y-axis
?sp z read the currently executed speed of Z-axis only, e.g. 0.000
?sp 6 read the currently executed speeds with 6 fractional digits
```



16.10. moe (Move Extended)

Syntax: !moe or moe
Parameter: Bit-mask followed by the there specified amount of target positions and distances in order X->A

Availability: 2nd generation TANGOs (e.g. Desktop HE).

Description: Flexible move instruction, combines absolute and relative moves on any combination of axes. It is possible to move e.g. only X and A in one instruction (and as a vector) or Y and Z and as well A relative, etc. All sorts of variations on up to 4 axes. The only restriction is that each axis (bit) can only be set as either abs or rel.

The moe instruction relies on the flag bits sent with moe:

Bits 0...3 = Axes for absolute move: 1=X, 2=Y, 4=Z, 8=A
Bits 4...7 = Axes for relative move: 16=X, 32=Y, 64=Z, 128=A

With this mask, 'moe' then is executed as:

"moe [Sum of Bits] [position(s) or distance(s)]" or
"moe x[Bits as hex] [position(s) or distance(s)]"

The two options (integer and hex) exist, as a hex number might be easier to understand than an integer sum.

Some examples of abs/rel combinations:

RELATIVE (axes for mor)				ABSOLUTE (axes for moa)					
A	Z	Y	X	A	Z	Y	X	Flag	bit sum for
128	64	32	16	8	4	2	1		
x80	x40	x20	x10	x08	x04	x02	x01		
0	0	0	0	0	0	0	0	= 0	no axis
0	0	0	0	0	0	0	1	= 1	absolute X
0	0	0	0	0	0	1	0	= 2	absolute Y
0	0	0	0	0	0	1	1	= 3	absolute X + Y
0	0	0	0	0	1	0	1	= 5	absolute X + Z
0	0	0	0	0	1	1	0	= 6	absolute Y + Z
0	0	0	0	1	1	0	0	= 12	absolute Z + A
0	0	0	0	1	1	1	0	= 13	absolute Y,Z,A
0	1	0	0	0	0	0	0	= 64	relative Z
0	1	0	0	0	0	0	1	= 65	relative Z, absolute X

Response: For further information on possible response characters, please refer to **move instructions**, **autostatus** and **statusaxis**.

Examples: moe 5 3.3 7.5 (1+ 4 : X and Z absolute to 3.3 and 7.5)
moe 65 10 0.5 (1+64 : X absolute to 10, Z relative by 0.5)
moe x41 10 0.5 (x01|x40: X absolute to 10, Z relative by 0.5)
moe 48 0.5 1.5 (16+32 : X and Y relative by 0.5 and 1.5)

16.11. a (Abort a currently running Move or Speed)

Syntax: !a or a or [hex 0x03]
Parameter: x, y, z, a or none
 -1 or none

Description: Aborts automatic moves (moa,mor,moc,go,...), cal/rm and speed instructions of all axes or of a specified axis and sets them into position reached state. The stop is performed with high acceleration of **stopaccel**. PCI-E and DT-E from Firmware 1.66, others from 1.68, support the optional parameter "-1", where the axis stops at regular **accel** acceleration (see examples).

Most TANGO controllers also provide the "Ctrl+C" (hex 0x03) special character stop, which bypasses the parser (faster response, independent of running instructions) to stop all axes and clear the input buffer.

Remarks: Abort might fail in special cases of closed loop errors. In such case, **closed loop** has to be deactivated as well.

HDI (joystick etc.) movement cannot be stopped by abort. The HDI must be disabled e.g. by setting **joy** or **joydir** to 0.

Accelfunc is not used, abort always stops with constant accel.

Response: Depends on the instruction being executed (moa,speed,go etc.) and **autostatus**. If a move is aborted in default **autostatus=1** and all axes stopped, the aborted axes auto response is 'E'.

The '**?err**' error state is not changed by the 'a' instruction and remains in the previous state.

Example: a (abort move of all axes , with **stopaccel**)
 a y (abort move of Y axis only, with **stopaccel**)
 a -1 (abort move of all axes , with **accel**)
 a z -1 (abort move of Z axis only, with **accel**)

16.12. delay (Set the Delay Time for Consecutive Moves)

Syntax: ?delay or !delay

Parameter: 0 to 10000 [ms]

Description: This instruction inserts a delay time before executing a move (delayed start). One value applies to all axes. Applies to: moa,mor,moc,mol,moe,m and snapshot mode 7, not to the go instruction. Also refer to "**!pause**".

Response: Delay time in [ms]

Examples:

!delay 500 Delay the start of a move instruction by 0.5 seconds

?delay Read the delay time

16.13. pause (Set the Pause after Position Reached)

Syntax: ?pause use or !pause

Parameter: 0 to 10000 [ms]

Description: Complementary to **delay**, this instruction adds a pause time after the axes have reached their target positions. In **autostatus=1** mode the "@@@" reply is delayed by this time. It may be used to insert an automatic settling time after moa,mor,moc,moe,m. One value applies to all axes.

Response: Pause time in [ms]

Examples:

!pause 10 Delay the **autostatus** response of a move by 10 milliseconds

?pause Read the pause time

16.14. block (Block the command interpreter)

Syntax: !block or block
Parameter: none or 1...8, optional 1 or 2 additional parameters

Availability: 2nd generation TANGOs (e.g. Desktop HE) from Firmware 1.77.

Description: Blocks the command interpreter, so the instructions that are sent after "block" will not be executed until the requested event occurred.
This enables the user or application to send sequences of instructions to the TANGO, which are executed one after the other. For example, cal, block, rm - which will wait until cal has completed and then execute rm afterwards. Which else would not be possible without waiting.

The block instruction can wait for several events or axes:

Type	Function / Option
none	= blocks until all axes are idle (incl. Cal/Rm)
1	= blocks until all (or the specified) axes are idle
2	= wait for a HDI key (option value = 1, 2, 4) **
3	= wait for IO pin (option value = +-1...5) *** (positive=wait for high, negative=wait for low)
4	= wait for a trigger event (for trigcount to increment)
5	= wait for a snapshot event (for snsc to increment)
6	= wait for reaching a certain trigcount value
7	= wait for reaching a certain snsc value
8	= wait for a time in milliseconds

*** AUX-IO: 1/-1 = Takt In
2/-2 = V/R In
3/-3 = Stop
4/-4 = SnapShot
5/-5 = TrIn I Motor Connector

Several block commands can be sent, example to first wait until axes have reached and then wait for the HDI F1 key.

Remarks: The TANGO input buffer can hold a maximum of 2048 characters. The sequence must not exceed the TANGO input buffer size. As the block instruction blocks the command interpreter, an active block cannot be aborted by an instruction (as "!a"). Only

- an optional timeout value or
** - pressing HDI F3 or
- disabling the PSE (PSE=Off)
can abort a block instruction. In those cases, the entire input buffer gets discarded so the sequence will end and not be continued.

Response: none

Examples:

block → wait endless until all axes are idle (XYZA)
block 1 → wait endless until all axes are idle (XYZA)
= same as without parameter
block 1 15 → wait endless until all axes are idle (XYZA)
block 1 5 → wait endless until the X and Z axes are idle (1+4)



```

block 1 4 60000 → wait max. 60 seconds for Z to become idle
block 2 1 → wait endless for the HDI F1 key to be pressed
block 2 1 10000 → wait max. 10 seconds for the HDI F1 key to be pressed
block 3 -1 → wait endless until the "Takt In" pin goes low
block 3 1 5000 → wait max. 5 seconds for the "Takt In" pin to go high
block 4 → wait until the trigger counter increases (trigcount)
block 5 → wait until the snapshot counter increases (snsc)
block 6 100 → wait until 100 trigger events counted (trigcount >= 100)
block 7 20 → wait until 20 snapshot events counted (snsc >= 20)
block 7 20 5000 → wait max. 5 seconds for snsc to reach 20
block 8 500 → just wait for half a second

```

```

Example Sequences:  1.          2.          3.
                    -----+-----+-----
                    cal      | block 2 1 | cal
                    block   | moa z 10  | block 1 3
                    rm      |          | moa 10 10

```

16.15. pos (Read or Set Position)

Syntax: !p s or ?pos
Parameter: x, y, z, a or none
 Position (within \pm maxpos)

Description: This instruction either reads or sets the axis position.
 If set, this defines a new absolute position of the axis.
 The unit depends on the selected dimension (**dim**).

From Firmware 1.73, 'pos' can also be sent without '?' to return a position.

Remarks: Even axes with encoders return the motor position by default.
 Returning the encoder position can be achieved by setting the
 corresponding '**encpos**' to 1.

The effect of manipulating positions with '!pos' can be removed by the instruction '**posclr**'. Also, the difference (offset) from the original zero position can be read by it.

Response: Axis position(s) (depends on **dim**, also **enc** and **encpos** state)

Examples: ?pos Read all axis positions
 ?pos z Read Z axis position only
 !pos 100 200 Set the current X and Y axis positions
 !pos x 0 Set the current X position to zero
 !pos -0.1 Set the current X position to -0.1 (unit depends on dim)
 !pos y 2000 Set the current Y position to 2000 (unit depends on dim)

16.16. posclr (Clear Position Offset)

Syntax: !posclr or ?posclr
Parameter: x, y, z, a or none

Description: Remove or read the position offset to the axis origin,
 which was added by a **!pos** instruction.

The axis position can be redefined by '!pos'. To return to the original absolute position, posclr offers reading or clearing the changes/shifts made by !pos.

Response: Position offsets (depending on **dim**)

Examples: !posclr x (reset X to original position)
 !posclr (reset all positions to original position)
 ?posclr (read position offset of all axes)

 ?pos => 1.0000 **2.0000** 3.0000
 !pos y 8 (here a position offset of 8-2=6 is added to Y)
 ?pos => 1.0000 **8.0000** 3.0000
 ?posclr => 0.0000 **6.0000** 0.0000
 !posclr (here the !pos set position offsets are removed)
 ?pos => 1.0000 **2.0000** 0.0000

16.17. zero (Set Internal Position to Zero)

Syntax: `!zero` or `zero`

Parameter: `x, y, z, a` or none

Description: Unlike "`!pos 0`", the "`!zero`" instruction also resets the internal position counter to zero. It can be used in applications where axes exceed the position limits, e.g. filter wheels (in such case a "`!pos 0`" instruction is not sufficient, as internal limits will apply). In order to ensure the reference point remains at the same position, the zero instruction should be executed after completing one or several complete revolutions.

Remarks: For rotational axes '`modulomode`' can be used. In these modes, setting the axes to zero is not required.

Response: none.

Examples:

```
!zero          Set all internal positions to zero  
!zero z       Set Z axis position to zero
```

16.18. clearpos (Set Internal Position to Zero)

Syntax: `!clearpos` or `clearpos`

Parameter: `x, y, z, a` or none

Description: For compatibility with Lstep controllers. Functionality is almost the same as with the '`zero`' instruction. The only difference is that the `clearpos` instruction is not executed when in closed loop.

Response: none.

Examples:

```
!clearpos     Set all internal positions to zero  
!clearpos x  Set X axis position to zero
```

16.19. limmove (Endless Move between the Axis Limits)

Syntax: !limmove or ?limmove

Parameter: x, y, z, a or none
0, 1, -1 or none

Description: Start an endless move between the axis limits. The limits can be defined by !lim, CAL/RM or the switches. Used e.g. for warmup, long-term testing and diagnosis. It is recommended to execute a CAL and RM before starting the limmove, so the axis travels within the travel range. If CAL and RM are not executed, the limit move constantly keeps traveling into, and from to, both limit switches of the axis.

The axis travels at the axis velocity (vel) or is limited by secvel, if CAL+RM are not executed.

0 = stops the limmove of an individual axis
1 = starts the limmove of an individual axis
-1 = starts the limmove of all axes (caution!) **
** (up to firmware 1.76, all axes started when executing "!limmove" without parameter. For safety, this was changed from firmware 1.77 to the parameter -1)

Diagnostic option:

When using limmove for long-term testing of axes, and CAL and RM were executed before, the axis will not travel into the limit switches. But if, especially in open loop axes, the motor stalls during the long-term test, it will lead to unrecognized position shift. This can be identified by checking, how often the limit switch was actuated. Usually never (0), this can indicate a loss of position if the number of actuation times increases.

"?limmove 1" requests the number of E0 and EE actuations of all axes since limmove was started.

Warning: The axis must be checked for possible collisions. Especially the Z-axis.

Remarks: Also refer to randmove for endless random move. Limmove and Randmove are similar functions, except limmove always travels the full range at the full velocity while randmove travels random steps at random velocities. Limmove and Randmove cannot be mixed. The TANGO either executes limit moves or random moves. The limmove can also be aborted by the abort (a) instruction.

Response: State of the limmove (1=active, 0=inactive)
or number of limit switch events during limmove as pairs of E0 and EE event counts.

Examples:

```
!limmove -1      (Start endless limit move for all axes)
!limmove 1 1     (Start endless limit move for X and Y)
!limmove 0 0 1   (Start endless limit move for Z, end the move for X and Y)
!limmove z 1     (Start endless limit move for Z)
!limmove y 0     (End limit move in Y)
?limmove        → 1 1 0      (Read limit move state for all axes)
?limmove x      → 1          (Read limit move state of X axis)
?limmove 1      → 0 83 0 0 0 0 (X-EE switch 83x actuated since started)
```

16.20. randmove (Endless Random Move of the Axis)

Syntax: !randmove or ? randmove

Parameter: x, y, z, a or none
0, 1, -1 or none

Description: Start an endless random move between the axis limits. The limits can be defined by !lim, CAL/RM or the switches. Used e.g. for endurance / long-term testing. The axis travels to random positions within the position range, and at a random velocity between 50% and 100% of the axis velocity (vel) or is limited by secvel, if CAL and RM are not executed.

It is important to execute a CAL and RM before starting the randmove, so the axis travels within the travel range. If the axis limits are not known (CAL and RM not executed), the random move applies the full theoretical travel range of the TANGO for random positions, which is mostly useless.

0 = stops the randmove of an individual axis
1 = starts the randmove of an individual axis
-1 = starts the randmove of all axes (caution!) **
** (up to firmware 1.76, all axes started when executing "!randmove" without parameter. For safety, this was changed from firmware 1.77 to the parameter -1)

Diagnostic option:

When using randmove for long-term testing of axes, and CAL and RM were executed before, the axis will not travel into the limit switches. But if, especially in open loop axes, the motor stalls during the long-term test, it will lead to unrecognized position shift. This can be identified by checking, how often the limit switch was actuated. Usually never (0), this can indicate a loss of position if the number of actuation times increases.

"?randmove 1" requests the number of E0 and EE actuations of all axes since randmove was started.

Warning: The axis must be checked for possible collisions. Especially the Z-axis.

Remarks: Also refer to limmove for endless limit move. Limmove and Randmove are similar functions, except limmove always travels the full range at the full velocity while randmove travels random steps at random velocities. Limmove and Randmove cannot be mixed. The TANGO either executes limit moves or random moves. The randmove can also be aborted by the abort (a) instruction.

Response: State of the randmove (1=active, 0=inactive)
or number of limit switch events during limmove as pairs of E0 and EE event counts.

Examples:

```
!randmove -1      (Start endless random move for all axes)
!randmove 0 0 1  (Start endless random move for Z, end the move for X and Y)
!randmove y 1    (Start random move in Y)
?randmove        → 1 1 0      (Read random move state for all axes)
?randmove x      → 1          (Read random move state of X axis)
?randmove 1      → 0 83 0 0 0 0 (X-EE switch 83x actuated since started)
```

17. HDI Instructions (Joystick, Trackball, ERGODRIVE)

The HDI (human device interface) provides manual control of the axes. The HDI accepts hot plugging of the devices. It is possible to unplug, plug in, or exchange the input devices during operation of the TANGO controller.

The HDI velocities are limited to the **secvel** velocity as long as no **cal** and **rm** sequence has been executed. The axis travel will stop at either the hardware limit switches or the software limits (defined by the **lim** instruction). The Joystick velocities and the maximum velocities for the ERGODRIVE are either taken from the current axis velocity **vel** or, if **extmode** is enabled (1), from the independent **joyvel**. Joyvel also limits the maximum velocity of all HDI devices.

The HDI can be disabled and enabled with the global "**joy**" and/or the individual "**joydir**" instruction. Joydir sets axes individually and can also reverse them. Since firmware 1.77, disabling the HDI (**joy**=0) can also be done by "**!joy -1**", which avoids the @@@ reply that the backward-compatible "**!joy 0**" can cause.

A disabled HDI (**joy**=0) still returns the key states through **key** and **key1**.

keymode enables selection of different **keyspeed** velocities by pressing the function keys F1-F4 of the joystick. Please refer to **keymode** for further information.

The function keys F1-F4 have several functions assigned, depending on selected modes, like e.g. snapshot (see chapter 18 "**Joystick Function Key Assignments**"). 2nd generation TANGOs from firmware 1.78 offer individual function assignment through the **keyfunc** and **keyfunctext** settings, which can overwrite or disable the default key functions, if required.

The joystick devices provide optional axis assignments, like

- swapping the X-Y assignment (**joychangeaxis**)
- or the Y-Z axis assignment (**hdimode** bit 9)
- assigning Z to A (**hdimode** bit 6)
- assigning the joystick Z axis to A while F4 is pressed (**configaxsel**)

2nd generation TANGOs from firmware 1.79 offer individual axis assignments for and to all available axes by the **joytoaxis** instruction. But the above mentioned functions are still available in parallel (backward compatible).

The joystick Y-axis by default counts in the opposite direction than the other axes (Y deflection up = Y travels backwards). This behavior can be removed by **configmathe** =1, which might also be useful when Y is assigned to a different axis by the **joytoaxis** settings.

The optional **multi-function wheel**, found on several HDI devices, can be assigned to any axis (by instruction **zaxis**) and the LED100 brightness (via **hdimode**).

The TVR inputs of the AUX I/O connector can also be used as input device (HDI). It is described in this chapter under **tvrjoy**, **tvrjoyf** and **tvr** in chapter 20.

17.1. Joystick Options Explained

Especially the Joystick has many options to assign, reverse or disable axes. This chapter explains the options of the 2nd gen. TANGOs from Firmware 1.79:

Globally disable the HDI:	<code>!joy -1</code> (or <code>!joy 0</code> , which might return an @@@@.)
Globally enable the HDI:	<code>!joy 2</code> (or <code>!joy 1</code> , which behaves the same)
Disable individual axes :	<code>joydir</code> (an axis instruction, where 0 = disabled)
Enable or reverse axes :	<code>joydir</code> (2 or 1 = not reversed, -2 or -1 reversed) (or use <code>joyvel = 0</code> or <code>joytoaxis = 0</code>)
Joystick Y-axis behavior:	<code>configmathe</code> (corrects the Joystick Y direction)
Combine axes :	<code>hdimode</code> bit 7 (all HDIs X axes control X and Y)
Swapping of axes :	<code>joychangeaxis</code> (swaps the Joystick X and Y axes) <code>hdimode</code> bit 9 (swaps the Joystick Y and Z axes) <code>hdimode</code> bit 6 (Joystick Z controls A, not Z) <code>configaxsel</code> (allows Z to Z/A toggle by key F4) *
Individual axis assign :	<code>joytoaxis</code> (assigns any Joystick axis to the TANGO axes, as a superset of the first 3 swapping options above, but would not override those if they are set **)
Auto-disable ***	<code>hdimode</code> bit 10 (disable the Joystick Z-knob, when X or Y deflected) <code>hdimode</code> bit 13 (disable the Joystick X and Y, when Z-knob deflected)
Quick-Stop	<code>hdimode</code> bit 11 (causes a faster stop of the Joystick axes, when no more deflected, e.g for focusing)

* `configaxsel Z → Z/A` is related to the TANGO axis, not to the Joystick. So the toggle takes place on TANGO Z/A, no matter where the physical deflection came from.

** The older axis swapping options (`joychangeaxis` and `hdimode` bits 9 and 6) have priority over the newer `joytoaxis` settings for backward-compatibility.

*** The auto-disable is always related to the physical XY/Z Joystick axes, no matter how they are assigned, because it is the intention to fix the influence from manual deflection of those axes.

With the TANGO Desktop 3HE, the axes that are controlled by the Joystick can be assigned to the optionally built-in POS3 3 axis controller: `hdimode` bit 12 assigns all 3 axes or none.

Further Joystick options are e.g. the Joystick keymode with the key speeds and optional key speed toggle mode set by `hdimode` bit 2. A trick to mention here would be setting the first key speed to 0, so then a button must be pressed (for the second key speed) to operate the joystick.

The optional Multi-Function Wheel has its own settings and can be found on several HDI devices. No description here.

17.2. joy (Generally Enable/Disable HDI)

Syntax: !joy or ?joy
Parameter: 0, 1, 2, 3, 4 or 5 (from firmware 1.77 also -1, see remarks)

Description: Globally enable or disable the connected HDI device (joystick, trackball, ERGODRIVE etc.)
It is recommended to only use the values 0 or 2. For compatibility, a value of 1 has the same effect as 2.

0 = OFF : disable HDI device
2 = ON : enable HDI device (default setting)

Important Advice: If joy is switched from an ON state to OFF (0), an automatic status reply (like "@@@-.") is generated.

Remarks: If this is not wanted a workaround is using **joydir** to disable the HDI or temporarily disabling **autostatus**.
From TANGO firmware 1.77 it is possible to also disable the HDI by "!joy -1" without generating the @@@ reply, the enable state is set to 0 (not -1).

Remarks: TANGOs keep reading the function key states even when joy is disabled by "!joy 0" or "!joy -1". The states can be read by "key", "keyl" and processed by the "keyfunc" modes.

Response: HDI enable state 0...5

Examples:
!joy 0 disable the HDI device (e.g. joystick) and speed instruction
!joy 2 enable the HDI device (default) and speed instruction
?joy read HDI enable state

Behavior examples / sequences:

?joy	→ 2	(HDI is enabled)
!joy 0	→ @@@-	(response when switched enable→disable with autostatus on)
!joy 0		(no response when joy already is disabled)
!joy 2		(no response when joy is enabled)

!autostatus 0		(workaround #1 to avoid response when disabling)
!joy 0		
!autostatus 1		

!joydir 0 0 0 0		(workaround #2 is to use ' joydir ' instead)
!joydir 2 2 2 2		(make sure the direction is correct, 2 or -2)

From firmware 1.77:

!joy -1 (disable the HDI **without causing an @@@ reply**)
?joy ==> 0 (the HDI is then disabled to 0)

17.3. joydir (Joystick Direction or Assign Joystick per axis)

Syntax: !joydir or ?joydir
Parameter: x, y, z, a or none
and 0, 1, 2, -1, -2

Description: In addition to the '**joy**' instruction, joydir can be used to enable/disable individual HDI axes and set their directions. For compatibility, a value of 1 or -1 has the same effect as 2 or -2. It is recommended to use the values 2, 0 or -2 only. The options are:

0 = Disable HDI axis (e.g. joystick deflection is ignored)
(1 = Enable HDI axis, ~~no motor current reduction~~)
2 = Enable HDI axis, current reduction supported (default)
(-1 = Same as 1, direction reversed)
-2 = Same as 2, direction reversed

Remarks: To activate the joystick, please also make sure that the joystick is globally enabled by the '**joy**' instruction.

When using a 4 axis controller with a 3 axis joystick, its 3rd axis will be used to control axes3 and 4. The selection which axis (3 or 4) is controlled must be selected by enabling or disabling the corresponding joydir. By default, the joydir of the 4th axis is disabled (0). Refer to examples below.

This instruction also enables or disables (0) the '**speed**' move for the corresponding axes, but does not affect the speed move directions (joydir 2 or -2 enables **speed**).

Response: HDI directions of the axes or specified axis

Examples:
!joydir -2 enable HDI X-axis in reversed direction
!joydir z 0 disable HDI Z-axis
!joydir 2 2 0 2 set positive direction, allow current reduction, assign the joysticks 3rd axis to the controller A axis instead of Z
?joydir read HDI enable/direction setting of all axes
?joydir y read HDI enable/direction setting of Y axis only

17.4. configmathe (Joystick Y Axis Direction)

Syntax: !configmathe or ?configmathe
Parameter: 0 or 1

Description: Remove or keep the default reversed Joystick Y-axis direction.

0 = Joystick Y-axis is reversed (Y up = negative, default)
1 = Joystick Y-axis not reversed (mathematically correct)

Remarks: A joystick deflection in Y behaves different than the other axes. This is historically the default. Use configmathe 1 to remove this behavior.

Response: Joystick Y-axis counting behavior, 0 or 1

Examples:
?configmathe => 0 Read the setting of the TANGO
!configmathe 1 Remove the reversed behavior from the Joystick Y-axis

17.5. joywindow (Joystick Window)

Syntax: !joywindow or ?joywindow
Parameter: 0 to 100

Availability: TANGO controllers with analog joystick (not digital).

Description: In case of an analog joystick, this instruction sets the center position threshold of the Joystick in 10bit digits. A deflection, when it is within the window, has no effect. The value defines the window width around the center. There is only one value for all axes. Assuming the joystick deflection value in the center is 512 in 10bit digits and a joywindow of 14 is set means, that from a joystick deflection value <505 or >519 the axis will start to travel. The window should not be set lower than the default value of 14, as this might result in slow unwanted creeping of axes even when the joystick is apparently not deflected. Increasing the value will reduce the velocity resolution (coarser velocity steps) but might help prevent creeping.

Remarks: TANGOs with digital HDI interface, as the TANGO integrale, TANGO 3 mini and all 2nd generation TANGOs, do not use the joywindow. There it is factory-stored in the HDI device. The joywindow instruction is supported, but has no effect.

Response: joywindow [in digits]

Examples: ?joywindow read joystick window
!joywindow 14 set joystick window to 14 (= ±7 digit)

17.6. joyvel (Joystick Velocity)

Syntax: !joyvel or ?joyvel
Parameter: x, y, z, a or none
0 or 0.000001 to 3000 [mm/s] **

Description: **Joyvel is used in extmode 1, else it serves as velocity limit.** In extmode=1 this instruction must be used to set the joystick velocities, because the vel instruction then has no influence to the joystick velocity. In normal mode (extmode=0) the joystick velocities are derived from the axis vel settings, but the joyvel setting is still used to limit the HDI velocities.

Remarks: When used with 1st generation TANGOs (PCI-E/DT-E etc.), sending !joyvel switches the TANGO to internally use joyvel instead of vel, even if extmode=0. 2nd gen. TANGOs do not allow this.

Remarks: ** From TANGO firmware 1.77, joyvel can also be set to 0, e.g. for disabling individual HDI axes. From Firmware 1.77 it is possible to request 0-16 fractional digits.

Response: Currently used joyvel, by default with 3 fractional digits, from firmware 1.77, 0 to 16 fractional digits can be requested

Examples:
!joyvel 12.5 20 0.4 Set joystick velocities for 3 axes
!joyvel z 1 Set joystick velocities for z to 1 [rev/s], (e.g. dim=2) or [mm/s] if dim=9 or 10
?joyvel x => 12.500 Read joyvel of X-axis with default digits
?joyvel x 4 => 12.5000 Read joyvel of X with 4 fractional digits (firmw.1.77+)



17.7. joyspeed (Joystick Speed Presets for BPZ Device)

Syntax: !joyspeed or ?joyspeed

Parameter: 1, 2 or 3 and
0.000001 to 200 [revolutions/s]

Description: **Only used by a customer designed HDI device** (called BPZ), this instruction sets the joystick speeds for the three speed buttons (Slow, Medium, Fast). Unit is in motor revolutions per second. While the velocity applies to all axes, each speed button can (must) be set individually:
1 = Slow Button speed, one parameter for all axes
2 = Medium Button speed, one parameter for all axes
3 = Fast Button speed, one parameter for all axes

Response: Speed currently assigned to the specified button in [rev/s]

Examples:

?joyspeed 1 Read "slow" joystick button speed
!joyspeed 3 30 Set "fast" joystick button speed to 30 [revolutions/s]

17.8. keymode (Joystick Key Mode)

Syntax: !keymode or ?keymode

Parameter: 0, 1 or 2

Description: Instead of the usual **vel** (or **joyvel** in extmode 1), keymode assigns the independent **keyspeed** velocities to the joystick. Each axis has its two dedicated **keyspeeds**, which can be selected (toggled) by the joystick function keys. The way how the speeds can be toggled is defined by '**hdimode**', bit 1.

The different keymodes 1 and 2 can be used to select the preferred speeds which are active on startup.

Keymode can be set to:

0 = keyspeed disabled, vel or joyvel is used (default)

1 = keyspeed for X,Y and Z velocity, preset is **keyspeed 1**

2 = same as 1, but preset is **keyspeed 2**

Depending on the selected toggle mode (by '**hdimode**' bit 1), the behavior is

A) **hdimode** bit 1 = 0 (no joystick toggle mode):

F4 : selects keyspeed 1 values of X and Y axis,

F1 : selects keyspeed 2 values of X and Y axis.

F3 : selects keyspeed 1 value of the Z axis,

F2 : selects keyspeed 2 value of the Z axis.

The F-key does not have to be pressed all time, as it immediately switches to the desired keyspeed.

B) **hdimode** bit 1 = 1 (joystick toggle mode):

F1 : toggles XY between the keyspeed values 1 and 2

F4 : toggles Z keyspeeds 1,2 (firmware 1.56 or higher)

Remarks: Please note that other special functions which require the same joystick buttons (e.g. **snapshot modes**) might interfere with keymode (keymode will still behave as required, but other functions might then be executed as well).

For joysticks with the optional multi-function wheel, three wheel velocities are available by pressing F1, F4 or no key. Please refer to the '**zwtravel**' description.

Response: keymode as decimal number

Examples:

!keymode 1 keyspeed 1 is active on startup

?keymode => 1 (keymode 1 is selected)

17.9. keyspeed (Joystick Key Speed Presets)

Syntax: !keyspeed or ?keyspeed

Parameter: x, y, z, a or none
0 or 0.000001 to 3000 [mm/s] **

Description: Two Joystick velocities can be set for each axis individually. The first parameter is called the slow value and the second parameter is fast. Unit is always mm/s, independent from **dim**. The keyspeeds become available through **keymodes** 1 and 2.

Remarks: In **Keymode** 1+2, the X and Y keyspeeds do toggle together by F4/F1, while the Z keyspeeds are toggled separately by F3/F2. A different toggle mode can be set by **hdimode** bit 1, where F1 toggles between the keyspeeds for X+Y instead of F4/F1 and F4 toggles between the keyspeeds for Z instead of F3/F2. The keyspeeds are limited to '**secvel**' as long as no **cal+rm** sequence is executed.

** From TANGO firmware 1.77, keyspeed can be set to zero (0).

Hints: Setting one keyspeed to zero could be used to have a startup setting where movement by the joystick is in fact disabled and the user must press a joystick function key in order to use the joystick (toggle it to a speed different from zero).

Response: Two floating point values per axis (1="slow" and 2="fast")
one axis : [keyspeed1] [keyspeed 2]
more axes: [k.spd.1_x] [k.spd.2_x] [k.spd.1_y] [k.spd.2_y] ...

Examples:

```
?keyspeed x          => 1.00 10.00          (Read X Joystick keyspeed)
?keyspeed            => 2.00 20.00 2.00 20.00 0.10 1.00 (Reply of a 3 axes TANGO)
!keyspeed z 0.1 1    (Set keyspeed1 to 0.1 and keyspeed2 to 1 [mm/s] for Z)
!keyspeed 5 20 2 10 0.2 2 (Set keyspeed of 3 axes at once)
```

17.10. keyfunc (HDI Key Function)

Syntax: !keyfunc or ?keyfunc

Parameter: -1, 0, 1 ... 127 and optional 2nd parameter 0 to 15

Availability: 2nd generation TANGOs from Firmware 1.78.

Description: Keyfunc assigns individual functions to the HDI keys. The default F1 to F4 key functions can be individually kept, disabled, or replaced by one of the keyfunc modes.

Many of the functions, but not all, allow or require a second parameter, which mostly is a bitmask for the axes in decimal format (X=1,Y=2,Z=4,A=8 and sums of it = 0...15). But it could also be a COM port where the reply should be returned to (if wanted) or a macro number 1...8. If the second parameter is not specified, it is internally set to 0.

Keyfunc offers a "one sets all" function to return all keys to the default (0) or to function disabled (-1). Other functions 1 to 127 must be assigned individually by key number, function number and if required, the second parameter.

Parameter 1:

- 0 = default key function of the TANGO (=default)
- 1 = all functions disabled, only key state readable
- 1 to 127 = key function, refer to table at chapter
"KeyFunc: Table of available Functions"

Optional second parameter, used for:

- Addressed axes: 0...15 (X=1,Y=2,Z=4,A=8), e.g. X+Y =1+2 =3
- Port reply:
 - 1 = USB1 (USB interface or PCI-E port, if available)
 - 2 = SER1 (main RS232 interface)
 - 3 = SER2 (2nd RS232 interface, if available)
 - 4 = ETH (Ethernet interface, if available)
 - 0 = none (no reply will be sent)
- Macro number: 1 to 8

When reading the key function, either all 4 functions are returned or, if the key number is specified, the function and the optional second parameter. Depending on the key function, the returned second parameter is don't care.

Remarks: The key states can always be read by the **key** and **key1** instructions. The key function text, used by keyfunc 70, can be specified by the **keyfunctext** instruction.

Response: Key function(s) as decimal number (either the 4 functions or the individual key function with its parameter)

Examples:

```
!keyfunc 0      one sets all: all key functions to TANGO default
!keyfunc -1     one sets all: all key functions to disabled
!keyfunc 3 4 7  set F3 to function 4, for axes XYZ (disable HDI axes X,Y,Z)
!keyfunc 2 70   set F2 to function 70 w/o parameter (keyfunctext w/o reply)
!keyfunc 2 70 1 set F2 to function 70, param =1 (keyfunctext, reply on USB)
!keyfunc 1 71 8 set F1 to function 71, param =8 (execute macro number 8)
?keyfunc => 71 70 4 0 (returns all 4 key functions F1-F4 without parameters)
?keyfunc 2 => 70 1 (returns the function of key F2 with its parameter)
```

17.11. keyfunctext (HDI Key Function Text)

Syntax: !keyfunctext or ?keyfunctext

Parameter: up to 63 ASCII characters

Availability: 2nd generation TANGOs from Firmware 1.78.

Description: Keyfunctext sets or reads the optional ASCII command string that can be executed via **keyfunc** 70.

The text can contain one or several TANGO instructions, separated by a '#', with a maximum length of 63 characters.

Depending on the second keyfunc parameter, a TANGO reply can be discarded or sent via a selected port. Refer to **keyfunc**.

Remarks: Only one text can be specified, not one for each key.

Response: Key function text. If empty, at least a '-' is returned.

Examples:

```
!keyfunc 2 70 1 set F2 to function 70, param=1 (keyfunctext, replies on USB)
```

```
!keyfunctext !autostatus0#mor x1#mor y-1#block#!autostatus1#?pos# (= 52 char)
```

```
?keyfunctext => !autostatus0#mor x1#mor y-1#block#!autostatus1#?pos#
```

```
<Pressing F2> => 2 times move relative without @@@ reply, then send pos via USB
```

17.12. keyfunclock (HDI Key Function Write Protection)

Syntax: !keyfunclock or ?keyfunclock

Parameter: 0 or 1

Availability: 2nd generation TANGOs from Firmware 1.78.

Description: Keyfunclock sets or removes the write protection of the keyfunc and keyfunctext settings.

0 = not locked (default)

1 = locked

When locked, writing to keyfunc and keyfunctext has no effect and error number 71 (write protect) is caused.

Remarks: When using SwitchBoard, the lock function can not be set or released by INI files. Either the keyfunclock command must be used or a dedicated button in the keyfunc settings.

Response: Key function lock state, 0 or 1

Examples:

```
!keyfunclock 0 remove write protection from keyfunc
```

```
?keyfunclock ==> 0
```

17.13. joycurve (Joystick Characteristic)

Syntax: `!joycurve` or `?joycurve`

Parameter: `x, y, z, a` or none
`0, 1, 2`

Description: The speed characteristic of Joystick deflection can be defined for each axis individually.

0 = Logarithmic (default)
1 = Linear
2 = Quadratic

Remarks: The default (logarithmic) setting is the most useful as it allows very fine positioning at lower deflections and high velocities towards the full deflection. Also applies to the "WheelJoy" function of the Multifunctoin Wheel.

Response: Currently used characteristic

Examples: `!joycurve 0 0 0` => set X,Y,Z axes to logarithmic
`!joycurve z 1` => set Z axis to linear
`?joycurve` => read characteristic of all axes
`?joycurve x` => read characteristic of the x-axis

17.14. key (Read HDI Device Key State)

Syntax: ?key or key

Parameter: none or key number 1, 2, 3, 4

Description: This instruction reads the state of all 4 or the specified HDI device key(s).

0 = key is currently released or not available

1 = key is currently pressed

Response: 1 or 4 Key states, each either 0 or 1

Examples: key => query all keys, returns 4 numbers, e.g. 0 0 0 0

key 1 => query only key 1 (e.g. F1 Joystick button)

key 3 => query only key 3 (e.g. F3 Joystick button)

17.15. keyl (Read HDI Device Latched Key State)

Syntax: keyl, ?keyl or !keyl

Parameter: none or key number 1, 2, 3, 4

Description: The ?keyl or keyl instruction reads the latched state of the specified or all 4 HDI device keys. The latched state of the requested key(s) is cleared after reading.

The instruction !keyl clears the latched state of the specified or all keys to zero (0) without reading.

0 = key is/was released since last keyl or ?keyl instruction

1 = key is/was pressed since last keyl or ?keyl instruction

Response: 1 or 4 Latched key states, each either 0 or 1

Examples: keyl => read+clear all 4 keys, returns e.g. 0 1 0 0

keyl 1 => read+clear only key 1 (e.g. F1 Joystick button)

?keyl 1 => same as "keyl 1"

!keyl 2 => clear latch state of key 2 only (to zero)

!keyl => clear latch state of all 4 keys (to zero)

17.16. hwfactor (Coaxial-/ERGODRIVE Transmission Factor)

Syntax: !hwfactor or ?hwfactor

Parameter: x, y, z, a or none
and -200.0 to 200.0

Description: Aaxis travel distance in millimeter per coaxial drive revolution. Negative factors reverse the travel direction. (The hardware provides about 100000 steps per revolution.)

Remarks: Some HDIs provide a switch to change between two different factors. Please refer to '**hwfactorb**'.

Response: Currently used factor(s)
As floatingpoint number(s) between -200.0 and +200.0

Examples:

```
!hwfactor 14 14 => One knob revolution in X or Y results in 14mm axis travel
!hwfactor x 100 => One knob revolution in X results in 100mm travel
?hwfactor      => Read transmission factor of all axes
```

17.17. hwfactorb (Alternate Coaxial-/ERGODRIVE Factor)

Syntax: !hwfactorb or ?hwfactorb

Parameter: x, y, z, a or none
and -200.0 to 200.0

Description: Alternate (second) parameter for travel distance per coaxial drive revolution '**hwfactor**'. Available with e.g. ERGODRIVE and Pilot stage. Negative factors reverse the travel direction.

Response: Currently used alternate coaxial drive factor(s)
As floatingpoint number(s) between -200.0 and +200.0

Examples:

```
!hwfactorb 26.6 26.6 => One knob revolution in X or Y results in 26.6mm travel
?hwfactorb y        => Read alternate transmission factor of Y axis only
```

17.18. hwfilter (Coaxial-/ERGODRIVE Noise Filter)

Syntax: !hwfilter or ?hwfilter

Parameter: 0 or 1

Description: Coaxial drive noise filter.

1 = Noise filter is active (recommended, default)
0 = Noise filter is deactivated (finer step resolution)**

The filter is activated/deactivated for X and Y axes at once.
** Disabling the filter can result in a finer resolution, but it also causes position inaccuracy e.g., between automatic moves or when the axis is not moving: Its signal noise will cause a permanent slight position jitter.

Response: State of the coaxial drive noise filter

Examples:

```
!hwfilter 0      Disable noise filter
?hwfilter        Read hwfilter state
```



17.19. **tbfactor (Trackball Factor)**

Syntax: `!tbfactor` or `?tbfactor`

Parameter: `x, y, z, a` or none
and `-200.0` to `200.0`

Description: Set or read the trackball sensitivity (transmission factor), which is a floating-point number between `-200.0` and `+200.0`. A negative value can be used to change direction (similar to '**joydir**'). The default factor is `1`.

Response: Currently used trackball factor(s)

Examples:

```
!tbfactor x 100 Set X axis 100 times more sensitive than the default  
!tbfactor y 12.5 Set Y axis 12.5 times more sensitive than the default  
!tbfactor 0.5 0.5 Set X+Y axis to half the default sensitivity  
?tbfactor Read sensitivity factor of all axes
```

17.20. `zwheel` (Is Multi-function Wheel Available)

Syntax: `?zwheel` or `zwheel`
Parameter: none

Description: Identify if the connected HDI device provides a Wheel.

0 = HDI device has no multi-function wheel
1 = HDI device has a multi-function wheel

Remarks: To identify the HDI device, use '`hdi`' instruction

Response: 0 or 1

Example: `?zwheel => 0`

17.21. `zwtravel` (Multi-function Wheel Travel per Revolution)

Syntax: `!zwtravel` or `?zwtravel`
Parameter: 1, 2 or 3 and
-50.0 to 50.0 [mm/revolution]

Description: Set or read the travel distances for one revolution of the multi-function wheel, available with several HDI devices, e.g. ERGODRIVE and Joystick.

1 = Default (used when no HDI function key is pressed)
2 = Used while Joystick F4 button is pressed (preset to slow)
3 = Used while Joystick F1 button is pressed (preset to fast)

Presets for travel distance are
1: 0.1 mm/rev (default factor)
2: 0.01 mm/rev (alternate factor, factory preset to slow)
3: 1.0 mm/rev (alternate factor, factory preset to fast)

Remarks: ERGODRIVE and Pilot stage only offer switching between two travel distances. In this case distance parameter 1 remains the default; parameter 3 is used as alternate second factor.

'`secvel`' and '`vel`' (or '`joyvel`' in `extmode` 1) may prevent faster traveling when turning the wheel.

It is possible to set negative values and by this offering direction change via HDI key.

The multi-function wheel can also be assigned to other axes with the '`zwaxis`' instruction. By default, it is set to Z.

Hints: For safety reasons, the default travel can be set to zero. So the axis will move only when a key is pressed (F1, F4).

Response: Travel distance(s) of the multi-function wheel

Examples:

```
?zwtravel          Read all 3 travel distances: [1:default] [2:slow] [3:fast]
?zwtravel 1        Read "default" travel distance
?zwtravel 2        Read "slow" travel distance
!zwtravel 3 2.5    Set "fast" travel distance to 2.5 [mm/revolution]
!zwtravel 1 0      Set "default" parameter to zero (inactive without keypress)
```

17.22. zwaxis (Multi-function Wheel Axis)

Syntax: !zwaxis or ?zwaxis

Parameter: x, y, z or a

Description: Assign multi-function wheel to an axis (default: z)
Remarks: Only axes which are available and enabled can be used, even for the LED100 control. Only 2nd generation TANGOs from firmware 1.76 allow to assign unavailable axes.

Response: x, y, z or a

Example: !zwaxis a (assign wheel to axis 4)
!zwaxis x (assign wheel to axis 1)
?zwaxis => z (wheel is currently assigned to 3rd axis)

17.23. zwfactor (Multi-function Wheel Factor)

Syntax: !zwfactor or ?zwfactor

Parameter: 0, 1, 2 ... to 20

Description: For custom designed applications only.
Increase Wheel transmission multiplier, default=1.

0 = Wheel has no effect
1 = Wheel default (1:1)
20 = Wheel travels 20 times more distance

Remarks: Useful in custom designs where the application requires a different rotary encoder to provide the wheel functionality. If the chosen encoder type provides less resolution than the Joystick multi-function wheel, zwfactor can be used to adapt the behavior (here: to achieve correct **zwtravel** distances). The multi-function wheel has a resolution of 480 counts/rev. In example if the encoder has 128 counts/rev, zwfactor can be set to 4.

Response: Multiplier

Example: !zwfactor 1 (set default multiplier, as for TANGO HDIs)
!zwfactor 5 (set multiplier for lower res. Encoder wheel)
?zwfactor (read the currently used multiplier)

17.24. zwpos (Multi-function Wheel Position Counter)

Syntax: !zwpos, zwpos or ?zwpos

Parameter: none

Description: Independent position counter of the Multi-function Wheel.

Remarks: Always counts 480 counts/rev, **zwfactor** has no influence. Only counts on **zwaxis** axes that have HDI enabled by **joy** and **joydir** and are available on the controller.

Response: Counter value as 32 Bit signed integer

Example: zwpos (read the position counter, same as ?zwpos)
!zwpos 0 (set position counter to zero)
!zwpos 2000 (set position counter to 2000)

17.25. tvrjoy (Pulse and Direction Joystick Functionality)

Syntax: !tvrjoy or ?tvrjoy

Parameter: x, y, z, a or 0

Description: Assigns the AUX IO pulse+direction inputs TAKT_IN and V/R_IN to an axis, providing a pulse and direction interface. The behavior is similar to the trackball HDI device.

Remarks: The function does not provide absolute positioning accuracy. It can be compared to a HDI device behavior.

This function is also available without connecting a HDI device, by entering **tvr mode 5** for the corresponding axis

0 = Disabled (default)
x = Assigned to X-axis, available from Firmware 1.76
y = Assigned to Y-axis, available from Firmware 1.76
z = Assigned to Z-axis
a = Assigned to A-axis

Response: Currently assigned axis

Examples:

```
!tvrjoy 0      Disable AUX I/O tvr joystick function
!tvrjoy z     Assign AUX I/O tvr joystick function to Z-axis
?tvrjoy       Query assigned axis
```

Example for TVR via AUX I/O standalone operation:

```
!tvrjoyf 1.0   Assign a factor of 1 (about 1/1000 motor rev. per pulse)
!tvr z 5       Enter tvr mode 5 in Z
!tvrjoy z     Assign tvr to the Z-axis
```

17.26. tvrjoyf (Pulse and Direction Joystick Factor)

Syntax: !tvrjoyf or ?tvrjoyf

Parameter: -200.0 to +200.0

Description: Set or read the AUX I/O pulse+direction factor for the **tvrjoy** function in **tvr mode 5**. A negative value changes the direction. The default setting is 1.

Remarks: One TVR pulse on the AUX I/O causes around 1/1000 stepper motor revolution in case of a 200 steps motor (1.8°). A 400 steps motor (0.9°) responses with 1/2000 rev per pulse. The pitch and gear settings must be considered, as the tvr-behavior is based on motor steps.

Response: Currently used tvr factor

Examples:

```
!tvrjoyf 10   Axis is 10 times more sensitive than the default setting
?tvrjoyf     Read tvrjoy transmission factor
```

17.27. hdi (Read HDI ID)

Syntax: ?hdi or hdi
Parameter: none or -1

Description: Read the ID number (type) of the connected hdi device.
ID numbers 0 to 15 represent HDI devices, 16 or -1 mean it is no device connected, 17 and 18 are internal processes while establishing a connection.

A second value, the ID match, shows how good the hardware ID code matches the theoretical ID value [in %]. This value should be more than 30 [%] for secure device identification. The ID match ranges from 0 (poor) to 100 (good) percent, digital HDIs always return 100.

The "?hdi -1" option is available from firmware 1.68. It returns the ID and % match plus a descriptive text, which also includes the optional multi-function wheel. The text is returned in brackets after the two values.

ID	DEVICE
0	(Reserved for special devices)
1	Coaxial drive
2	Custom designed console
3	ERGODRIVE
4	SmartMove
5	Custom device
6	Custom device
7	Stand alone Jogwheel/Multi-Function Wheel
8	-
9	-
10	2x 2-Axis Joystick or 4-Axis Jogbox
11	Trackball with 2-Axis Joystick
12	Joystick 2-Axis
13	Trackball with 3-Axis Joystick
14	Trackball
15	Joystick 3-Axes
16	No device connected
17	(Device identification in progress)
18	(Device initialization in progress)
-1	No device connected (Digital HDIs)

Remarks: The instruction may be used to identify the connected HDI device. Additionally, '**zwheel**' can be used to identify if the device provides an additional multi-function wheel.

Response: HDI ID number, and the hardware coded ID match in percent.
When requested with parameter -1, plus a descriptive text.

Example:

```
?hdi       => 12 97 (HDI ID = device nr. 12, 97% match)
?hdi -1 => 12 97 [Joystick 2 axis] (device description text)
?hdi -1 => 15 93 [Joystick 3 axis with MF-Wheel]
?hdi       => 16 99 (ID 16 = no hdi connected, analog HDI)
?hdi       => -1 100 (ID -1 = no hdi connected, digital HDI)
?hdi -1 => 16 100 [No device connected] (analog & digital)
```

17.28. hdimode (HDI Mode Options)

Syntax: ?hdimode or !hdimode
Parameter: a string of 0s and 1s (to set LSB or more bits at once)
or two numbers, 0 to 15 and 0 or 1 (to set a single bit)

Description: Select extended HDI device options.
Options may either be set by a string of bits (0s and 1s) or by specifying bit number and logic state (on/off = 1/0). The string is LSB first (bit 0 is the first and leftmost) and can be truncated at any length (not all 16 bits required). Setting a bit to 1 enables the functionality, 0 disables it.

<u>Bit</u>	<u>Function</u>
------------	-----------------

- | | |
|-----|---|
| 0: | Toggle Mode for ERGODRIVE XY and Z Keys (0=off, 1=on) |
| 1: | Toggle Mode for Joystick (in KeyMode 1 or 2)
0=select KeySpeed velocity XY with F1+F4, Z with F2+F3
1=toggle KeySpeed velocity XY by just pressing F1
F4 is used to toggle Z (firmware 1.56 and higher) |
| 2: | LED100 brightness control via Joystick or ERGODRIVE (1=enabled). The AUX I/O TAKT_OUT pin is controlled automatically then (LED digitally switched of at 0%)
Remarks: If enabled, it can interfere with the second Trigger Output respectively adigout 0 . |
| 3: | LED100 fine manual brightness control,
16x finer with Multifunction Wheel
4x finer when controlled via Joystick Y deflection
(1=fine mode enabled, only in conjunction with Bit 2) |
| 4: | LED100 as main function of the Multifunction Wheel.
The function key (Joystick: F2, ERGODRIVE: F1) which must be pressed to control the LED is now used to drive the assigned axis instead. |
| 5: | - reserved - |
| 6: | Joystick Z knob drives the A axis (axis 4 instead of 3) |
| 7: | Diagonal mode (HDI X applied to X and Y simultaneously) |
| 8: | Trackball Y axis drives the Z axis (X then is disabled) |
| 9: | Joystick Y drives Z axis (and Z drives Y, if 3 axis JS) |
| 10: | Joystick Z knob is auto-disabled while X or Y deflected |
| 11: | Joystick fast stopping with stopaccel (@ 2 nd gen. 1.77+) |
| 12: | Joystick redirected to POS3_23 module (@ 2 nd gen. 1.78+) |
| 13: | - reserved - |
| 14: | - reserved - |
| 15: | - reserved - |

Response: Single mode bit or all 16 mode bits in one ASCII string

Examples:

```
!hdimode 2 1 Set mode bit 2 to 1 (on) = LED100 brightness control via HDI
!hdimode 3 0 Set mode bit 3 to 0 (off)= Coarse LED100 brightness control
!hdimode 1 Set mode bit 0 to 1 (on) (equal to "!hdimode 0 1")
!hdimode 100010 Set mode bits 0 and 4 to "on", bits 1,2,3,5 to "off". Bits
6...15 I left unchanged.
?hdimode 1000100000000000 Read the state of all 16 mode bits, LSB left
?hdimode 0 Read the state of mode bit 0 (ERGODRIVE toggle mode)
```

17.29. joychangeaxis (Change Joystick X and Y Axis)

Syntax: `!joychangeaxis` or `?joychangeaxis`
Parameter: 0 or 1

Description: Change the assignment of the Joystick X and Y axes.

0 = no change (default)
1 = Joystick X and Y axes changed (X=Y, Y=X)

Remarks: Only for Joystick devices.
Setting `joychangeaxis` to 1 overwrites a `joytoaxis` assignment.

Response: Joystick X-Y axis change state (0 or 1)

Examples:
`!joychangeaxis 1` change X and Y axis of the Joystick
`?joychangeaxis` read Joystick X,Y change state

17.30. joytoaxis (Freely assign Joystick Axes to Motor Axes)

Syntax: `!joytoaxis` or `?joytoaxis`
Parameter: `x, y, z, a` or none
0,1,2,3, or 4

Availability: 2nd generation TANGOs (e.g. Desktop HE) from Firmware 1.79.

Description: Assign the joystick axes (1-4) to any motor axis (x-a).
Replaces the `joychangeaxis` instruction and `hdimode` bits 6 and 9 in a more flexible way.

Joystick axes can also be disabled (0) or multiple assigned.

The axis parameter `x,y,z,a` here represents the motor axis, while the numbers 1 to 4 represent the joystick axes `x..a`:

0: no joystick axis assigned to the TANGO axis
1: joystick axis 1 (X) is assigned to the axis
2: joystick axis 2 (Y) is assigned to the axis
3: joystick axis 3 (Z) is assigned to the axis
(4: joystick axis 4 (A) is assigned to the axis) *not available*

Remarks: Only for Joystick devices.
For backward compatibility, the other axis change instructions of `joychangeaxis 1` (swap XY) and mode bit 6 (swap ZA) and bit 9 (swap XZ) overwrite a `joytoaxis` assignment.
'**configaxsel**' and '**configmathe**' will also work as before with older firmware.

Response: Joystick axis assignment(s)

Examples:
`?joytoaxis` => 1 2 3 4 (read the assignment of all axes)
`?joytoaxis y` 2 (read the assignment for the Y-axis, here: Y=2=Y)
`!joytoaxis y 0` (disable joystick on Y axis = do not assign a joystick axis)
`!joytoaxis 2 2` (assign the joystick axis 2 to the motor X and Y axes)
`!joytoaxis 0 0 1` (assign the joystick axis 1 to the motor Z axis, disable X, Y)
`?joytoaxis z` => 1 (the joystick axis 1 is assigned to the Z-axis)

17.31. configaxsel (Joystick Axis Select Option)

Syntax: !configaxsel or ?configaxsel

Parameter: 0 or 1

Description: Enable (1) or disable (0) the axis select functionality for joysticks. The z-knob is assigned depending on F4.

Used with 4 axis TANGO controllers to
- control the A axis while pressing the HDI F4 key and
- else, with F4 released, control the Z axis as usual.

1 = axis select enabled (pressing F4 key → A-axis used)

0 = axis select disabled (default : joystick Z always Z-axis)

Remarks: Please make sure that the joystick function for the A axis is enabled ('**joydir a**' instruction).

If Hdimode bit 6 is set (Z to A), axiselect does not work.

Response: Axis select configuration, 0 or 1

Examples:

!configaxsel 1 Axis select enabled (F4 applies Z→A with 3 axes joystick)

!configaxsel 0 Axis select disabled (default)

?configaxsel Read the axis select configuration (returns 0 or 1)

18. Joystick Function Key Assignments

The Joystick provides 4 function keys, F1-F4. The key states can be read by the **key** and **key1** instructions. Several operating modes of the TANGO controller also assign special functions to the F-keys. The chart shows the key assignments for the different modes:

Mode / Key	F1	F2	F3	F4	
SnapShot Mode	0	-	set new point	-	
	1	-	next point	-	
	2	previous point	next point	prehome & first point	prehome & home
	3	-	start dissection	-	-
	7	Move sequence prehome & home	autoinc from 1 st point	pause/continue	pause & previous point
	9	Relative Jump back	Relative Jump forward	-	-
Axis Select Mode ²⁾	-	-	-	Joystick Z-Axis controls A-Axis ¹⁾	
KeyMode	Select X,Y KeySpeed2	Select Z KeySpeed2	Select Z KeySpeed1	Select X,Y KeySpeed1	
KeyMode+Toggle	Toggle X,Y KeySpeed	Toggle Z KeySpeed	-	-	
Joystick has wheel	zwtravel3 (fast) ₁₎	-	Wheel "Joystick" ¹⁾	zwtravel2 (slow) ₁₎	
LED Mode no wheel	-	-	Y-axis controls LED brightness ¹⁾	-	
			F3+F4: Store LED brightness		
LED Mode w. wheel	zwtravel3 (fast) ₁₎	Wheel controls LED brightness ¹⁾	Wheel "Joystick" ¹⁾	zwtravel2 (slow) ₁₎	
			F3+F4: Store LED brightness		

1) Function selected only as long as key pressed.
In all other cases the function is selected or executed by pressing the key.

2) F4 can be configured as Axis Select (Z<->A). Please refer to '**configaxsel**'.

Remarks: When selecting more than one mode, function keys may become assigned to several functions at once.

Joysticks with multi-function wheel behave different in case of LED control than josticks without a wheel (refer to chart above).

For snapshot modes, please refer to chapter 27.6:

Snapshot Mode Description and Examples

2nd generation TANGOs from firmware 1.78 offer individual key function assignment through the **keyfunc** and **keyfunctext** settings, which can overwrite or disable these default key functions, if required. Refer to the next chapter 19.

19. HDI Key Functions (keyfunc)

2nd generation TANGOs from Firmware 1.78 allow assigning of individual functions to the HDI keys. The default F1 to F4 key functions can be individually kept, disabled, or replaced by one of the keyfunc modes -1 to +127.

Setting a keyfunc (different from 0) removes the default key function, but the key states (key, keyl) can still be read.

Many of the functions, but not all, allow or require a second parameter, which mostly is a bitmask for the axes in decimal format (X=1,Y=2,Z=4,A=8 and sums of it = 0...15). But it could also be a COM port where the reply should be returned to (if wanted) or a macro number 1...8, or a filter position, etc.:

2nd Parameter for

- Addressed axes as axis bits: 0...15 (X=1, Y=2, Z=4, A=8), e.g. X+Y = 1+2 = 3
- Port reply:
 - 1 = USB1 (USB interface or PCI-E port, if available)
 - 2 = SER1 (main RS232 interface)
 - 3 = SER2 (2nd RS232 interface, if available)
 - 4 = ETH (Ethernet interface, if available)
 - 0 = none (no reply will be sent)
- Macro number: 1 to 8
- Wheel Position (Filter/Reflector, Revolver, Turret Wheel)

It is also possible to send an individual instruction text of up to 63 ASCII characters which includes one or several TANGO instructions, separated by a '#'. The text is defined by "!keyfunctext", only one text is available, used by keyfunc 70. If more instruction sequences are required, macros may be used.

The HDI Key functions are grouped by functionality, existing gaps might be filled in future firmware versions while the currently defined functions and their numbers remain.

The keyfunc implementation of firmware 1.79 is described on the next pages.

Corresponding instructions: keyfunc and keyfunctext, also keyfunclock

Examples

```
!keyfunc 0           one sets all: all key functions to TANGO default
!keyfunc -1         one sets all: all key functions to disabled (state can still be read)
!keyfunc 3 4 7      set F3 to function 4, for axes XYZ (disable HDI axes X,Y,Z = 1+2+4 = 7)
!keyfunc 2 70       set F2 to function 70 without parameter (execute keyfunctext without reply)
!keyfunc 2 70 1     set F2 to function 70 with parameter =1 (execute keyfunctext, reply on USB)
!keyfunc 1 71 8     set F1 to function 71 with parameter =8 (execute macro number 8)
?keyfunc            → 71 70 4 0           (returns all 4 key functions F1-F4 without parameters)
?keyfunc 2         → 70 1               (returns the function of key F2 with its parameter)
!keyfunctext !autostatus0#mor x1#mor y-1#block#!autostatus1#?pos# (here 52 of 63 char. used)
?keyfunctext      → !autostatus0#mor x1#mor y-1#block#!autostatus1#?pos#
<Pressing F2>    → 2 times move relative without @@@ reply, then pos sent via USB
```

19.1. KeyFunc: Table of available Functions

Function number description of the keyfunc numbers and parameter.

Keyfunc	Description	Parameter
-1	No key function (neither keyfunc nor default), key state is readable	-
0	Default key function of the TANGO	-
-----	HDI Specific Functions -----	-----
1	HDI Disable / Enable toggle function (joy 0 / joy 2)	-
2	HDI Disable	-
3	HDI Enable	-
4	HDI axes disable (joydir) of specified axes:	Axis bits 0...15
5	HDI axes enable (joydir) of specified axes:	Axis bits 0...15
6	Set Joystick velocity to "vel" for the specified axes:	Axis bits 0...15
7	Set Joystick velocity to "Keyspeed 1" for the specified axes:	Axis bits 0...15
8	Set Joystick velocity to "Keyspeed 2" for the specified axes:	Axis bits 0...15
9	Toggle Joystick velocity between "Keyspeed" 1 and 2 for:	Axis bits 0...15
10	Multifunction Wheel to "fast" (zwtravel 3) by once pressing	-
11	Multifunction Wheel to "slow" (zwtravel 2) by once pressing	-
12	Multifunction Wheel to default (zwtravel 1) by once pressing	-
13	Multifunction Wheel toggle between fast / default	-
14	Multifunction Wheel toggle between slow / default	-
15	Multifunction Wheel toggle between slow / fast / default	-
16	Multifunction Wheel "Joystick" while pressed	-
17	Multifunction Wheel toggle between LED100 and positioning	-
18	Multifunction Wheel set to positioning (not to LED100)	-
19	Multifunction Wheel set to LED100 (not to positioning)	-
20	Multifunction Wheel toggle between LED100 fine / coarse	-
21 ... 29	-- unused --	
-----	Abort Functions -----	-----
30	Abort a running move on all axes and also a running macro	-
31	Abort a running move with stopaccel on the specified axes:	Axis bits 0...15
32	Abort a running move with accel on the specified axes:	Axis bits 0...15
33, 34	-- unused --	
-----	CAL / RM Functions -----	-----
35	Calibrate (CAL) the specified axes:	Axis bits 0...15
36	Range Measure (RM) the specified axes:	Axis bits 0...15
37	InitXY sequence (CAL, RM, MOC) slow x-y order version	None or reply port no.
38	InitXY 1 sequence (CAL, RM, MOC) fast simultan. version	None or reply port no.
39	-- unused --	
-----	Move Functions -----	-----
40	Move to Center Position (MOC X+Y)	-
41	Move to Center Position (MOC) of the specified axes:	Axis bits 0...15
42	Move Relative by jump distances of "snsj"	Axis bits 1...14 (0, 15 = all)



43	Move Relative by jump distances of "snsj" backwards (-)	Axis bits 1...14 (0, 15 = all)
44	Move Absolute to "home" position on the specified axes:	Axis bits 0...15
45	Move Absolute to "prehome" position on the specified axes:	Axis bits 0...15
46	Move Absolute via "prehome" to "home" on specified axes:	Axis bits 0...15
47 ... 49	-- unused --	
----- Remember → Move To Functions -----		
50	Remember the current axis positions	-
51	Move to the remembered positions (all axes)	-
52	Move to the remembered positions on the specified axes:	Axis bits 0...15
53, 54	-- unused --	
----- Snapshot Functions -----		
55	Take Snapshot (capture positions to sns_a), sns must be 1	-
56	Move to first entry of the snapshot array (sns_a)	-
57	Move to last entry of the snapshot array (sns_a)	-
58	Move forward through the snapshot positions (sns_a)	-
59	Move backward through the snapshot positions (sns_a)	-
60 ... 63	-- unused --	
64	Delete the entire snapshot array	(from Firmware 1.79)
----- Trigger Functions -----		
65	Force a trigger pulse (if trigger is enabled)	-
66	Enable manual trigger mode 102 and force a positive trigger	-
67 ... 69	-- unused --	
----- Execute Own Commands -----		
70	Execute TANGO ASCII command(s) defined by !keyfunctext	None or reply port no.
----- Macro Functions -----		
71	Start a Macro	Macro number 1...8
72	Abort a running Macro (running moves of the macro will not stop)	-
73, 74	-- unused --	
----- MW Filter Wheel Functions -----		
75	MW Filter Wheel: Initialize	-
76	MW Filter Wheel: Move to 1 st Filter Position	-
77	MW Filter Wheel: Move to specified Filter Position:	Filter Position
78	MW Filter Wheel: Move to next filter (+)	-
79	MW Filter Wheel: Move to previous filter (-)	-
----- MW Objective Revolver Functions -----		
80	MW Objective Revolver: Initialize	-
81	MW Objective Revolver: Move to 1 st Objective Position	-
82	MW Objective Revolver: Move to specified Objective Position:	Objective Position
83	MW Objective Revolver: Move to next objective (+)	-
84	MW Objective Revolver: Move to previous objective (-)	-
----- MW Filter and Revolver Combined Functions -----		
85	MW Filter and Revolver: Initialize both	-
86	MW Filter and Revolver: Move both to the specified position:	Same Position, e.g. 1
87 ... 89	-- unused --	



-----	Nikon FL-Turret (or WM RS232 External Filter) Functions -----	-----
90	Nikon FL-Turret: Initialize	-
91	Nikon FL-Turret: Move to 1 st Turret Position	-
92	Nikon FL-Turret: Move to specified Turret Position:	Turret Position
93	Nikon FL-Turret: Move to next turret (+)	-
94	Nikon FL-Turret: Move to previous turret (-)	-
95	Nikon FL-Turret: Open Shutter	-
96	Nikon FL-Turret: Close Shutter	-
97	Nikon FL-Turret: Continuous Mode On	-
98	Nikon FL-Turret: Continuous Mode Off	-
99...126	-- unused --	
-----	System Functions -----	-----
127	Reset the TANGO Controller	<i>(from Firmware 1.79)</i>

20. Digital and Analogue I/O

TANGO Desktop, Desktop-S/-E/ HE, PCI/PCI-S/PCI-E and TANGO 3 mini controllers provide several I/O options which become available with

1) the (optional) auxiliary I/O port "AUX I/O"

Which provides 5V digital I/O, analogue output(s), analogue input and more. In case of Desktop HE, the AUX I/O is always present, and the TANGO 3 mini has a slightly different "AUX mini". Other controllers can be ordered with AUX I/O. For I/O instructions, refer to **adigin**, **adigout**, **anain**, **anaout**, **anamode**, **tvr** and in case of TANGO 3 mini or Desktop HE also **adigintyp** and **adiginfunc**.

When the AUX I/O or AUX mini port is present, the digital and analog outputs can be used. Only the trigger (out) and snapshot (trigger in) functions must be activated by factory.

The analog outputs can be used e.g. to control Piezo Z-stages or illumination.

The analog input can be used for measuring purposes, it is also captured by snapshot events. In special "**anamode**"s, the analog input can control the Z-axis, e.g. for external autofocus control.

A **pulse and direction input** is available on AUX I/O ports only (not AUX mini), which can be used to drive an axis by applying a pulse and a direction signal. The pulse frequency is limited to a few 100kHz due to an 1nF+1kΩ input filter, and the direction signal is checked every 160µs. The pulses arriving in a 160µs interval are counted in this direction. For further information, please refer to the **tvr** description.

2) optional I/O extension port modules (Multi I/O preferred)

TANGO PCI-E or HE based controllers with optional **I/O1** or **Multi I/O** port module provide additional 24 or 12 digital inputs and 8 digital outputs via **digin/digout**, **edigin/edigout** etc. '**det**' may be used to check if a module is installed. A preset value can be assigned to the outputs which defines the initial state after power up.

Remarks: In case of I/O1 and Multi I/O modules, the **brake** functionality can interfere with the digital outputs. If a motor brake is activated, it occupies the specified output pin(s) which are controlled by the brake and can't be set by digout, edigout.



20.1. digin (I/O1 Digital Inputs)

Syntax: ?digin or digin
Parameter: none or 0 to 23

Availability: IO1 extension module on a TANGO PCI-E/DT-E or Desktop 3HE.
Remarks: For Multi-IO modules (I/O2), please refer to 'edigin'.

Description: This instruction reads the logic state of one or all digital inputs of the optional digital I/O1 extension.
If called without parameter, all inputs are returned as a string of 24 characters. If called with parameter (input number), only the state of the specified input is returned.

Response: logic state of digital input(s)
ASCII string 0 or 1, LSB (IN0) is the first/leftmost character
0 = low, 1 = high (depends on the polarity setting **diginpol**)

Examples:
?digin read all 24 digital inputs (e.g. 000000000000000000000000)
?digin 8 read logic level of input 8 (response e.g. 1)

20.2. digout (I/O1 Digital Outputs)

Syntax: !digout or ?digout
Parameter: string of up to 8 characters 0 and 1,
or single bit access with output number 0 to 7 and state 0, 1

Availability: IO1 extension module on a TANGO PCI-E/DT-E or Desktop 3HE.
Remarks: For Multi-IO modules (I/O2), please refer to '**edigout**'.

Description: This instruction sets or reads back the logic level of one or all digital outputs of the optional digital I/O1 extension.
Outputs may be set either by a string of levels (up to eight 0s and 1s) or by output number and signal level.
The string is LSB first (output 0 is the first/leftmost).
By reading back, the desired output states are returned, not the state of the output pins.

Response: current output state(s)

Examples:
!digout 11110000 The digital outputs 0,1,2,3 are set to logic '1' and the outputs 4,5,6,7 are set to logic '0'.
!digout 100 The digital output 0 is set to logic '1' and the outputs 1 and 2 are set to logic '0'. Outputs 3 to 7 are left unchanged.
!digout 5 1 set digital output 5 to logic 1 (high)
!digout 7 0 set output 7 to 0 (low)
?digout read the state of all outputs
?digout 5 read the state of output 5

20.3. diginpol (I/O1 Digital Input Polarity)

Syntax: !diginpol or ?diginpol
Parameter: string of up to 24 characters 0 and 1,
or single bit with two numbers 0 to 23 and 0 or 1

Availability: IO1 extension module on a TANGO PCI-E/DT-E or Desktop 3HE.
Remarks: For Multi-IO modules (I/O2), please refer to '**ediginpol**'.

Description: This instruction sets or reads back if the I/O1 input signal inverters are activated or not. Each of the 24 inputs can be inverted individually.
The inverter may be set either by a string of levels (up to 24 0s and 1s) or by specifying the input number and inverter state. The string is LSB first (input 0 is the leftmost).

Response: currently applied inverter setting(s)

Examples:
!diginpol 010000000000000000000000 Set all inverter states (IN1 to inverted)
!diginpol 11000 The digital inputs IN0 and IN1 are set inverted, IN2, 3 and 4 are set to non inverted, input IN5 to IN23 settings are left unchanged
!diginpol 5 1 activate inverter of digital input IN5 only
!diginpol 17 0 disable inverter of digital input IN17 only
?diginpol read the input inverter setting of all 24 inputs
?diginpol 5 read the input inverter setting of input 5 only

20.4. digintyp (I/O1 Digital Input Type)

Syntax: !digintyp or ?digintyp
Parameter: string of up to 6 characters 0 and 1,
or single bit access with block number 0 to 5 and state 0, 1

Availability: IO1 extension module on a TANGO PCI-E/DT-E or Desktop 3HE.
Remarks: 24 Volt configured IO1 modules only work with pull-down (0).
For Multi IO extension modules, please refer to '**edigintyp**'.

Description: Set or read back the pull-up/pull-down resistor settings for the 24 digital inputs of the IO1 extension.
The resistors are arranged in 6 blocks, where one block sets 4 inputs (6x4=24): IN0-3, IN4-7, IN8-11, ... IN20-IN23.

0 = pull down
1 = pull up

The pull up/down may be set either by a string of levels (up to 6 0s and 1s) or by specifying the block number and level. The string is LSB first (block 0 is the leftmost).

Response: currently applied pull up/down setting(s)

Examples:
!digintyp 110000 Set all pull up/downs (IN0-IN7 to pull up, rest to pull down)
!digintyp 001 Set pull up/down of IN0-IN7 to pull down, IN8-IN11 to pull up the settings for IN12 to IN23 are left unchanged
!digintyp 4 1 set block 4 (IN16-IN19) to pull up
!digintyp 2 0 set block 2 (IN8-IN11) to pull down
?digintyp read the pull up/down setting of all 6 blocks
?digintyp 5 read the pull up/down setting of input 5 only



20.5. digoutpreset (I/O1 Digital Output Presets)

Syntax: `!digoutpreset` or `?digoutpreset`
Parameter: string of up to 8 characters 0 and 1,
or single bit access with output number 0 to 7 and state 0, 1

Availability: IO1 extension module on a TANGO PCI-E/DT-E or Desktop 3HE.
Remarks: For Multi-IO modules, please refer to '**edigoutpreset**'.

Description: This instruction sets or reads back the logic levels of one or all digital outputs of the optional digital I/O1 extension, which are applied after power up of the TANGO. Output preset levels may be set either by a string of levels (up to eight 0s and 1s) or by output number and signal level. The string is LSB first (output 0 is the leftmost).

Response: output preset value(s)

Examples:

```
!digoutpreset 11110000 After power on, the digital outputs 0,1,2,3 are set to logic '1' and the outputs 4,5,6,7 are set to logic '0'
```

```
!digoutpreset 100 After power on, the digital output 0 is set to logic '1' and the outputs 1 and 2 are set to logic '0'. Outputs 3 to 7 are left unchanged.
```

```
!digoutpreset 5 1 set preset value of output 5 to logic 1 (high)
```

```
!digoutpreset 7 0 set preset value of output 7 to 0 (low)
```

```
?digoutpreset read the state of all outputs
```

```
?digoutpreset 5 read the state of output 5
```

20.6. edigin (Multi I/O Digital Inputs)

Syntax: ?edigin or edigin
Parameter: none or 0 to 11

Availability: Multi-IO extension module on TANGO PCI-E/DT-E or Desktop 3HE.

Description: This instruction reads the logic state of one or all digital inputs of the optional Multi I/O digital extension port. If called without parameter, all inputs are returned as a string of 12 characters. If called with parameter (input number), only the state of the specified input is returned.

Response: logic state of digital input(s)
ASCII string 0 or 1, LSB (IN0) is the first/leftmost character
0 = low, 1 = high (depends on the polarity setting **ediginpol**)

Examples:
?edigin read all 12 digital inputs (e.g. 000000000000)
?edigin 8 read logic level of input 8 (response e.g. 1)

20.7. edigout (Multi I/O Digital Outputs)

Syntax: !edigout or ?edigout
Parameter: string of up to 8 characters 0 and 1,
or single bit access with output number 0 to 7 and state 0, 1

Availability: Multi-IO extension module on TANGO PCI-E/DT-E or Desktop 3HE.

Description: This instruction sets or reads back the logic level of one or all digital outputs of the optional Multi I/O extension port. Outputs may be set either by a string of levels (up to eight 0s and 1s) or by output number and signal level. The string is LSB first (output 0 is the first/leftmost). By reading back, the desired output states are returned, not the state of the output pins.

Response: currently applied output state(s)

Examples:
!edigout 11110000 The digital outputs 0,1,2,3 are set to logic '1' and the outputs 4,5,6,7 are set to logic '0'.
!edigout 100 The digital output 0 is set to logic '1' and the outputs 1 and 2 are set to logic '0'. Outputs 3 to 7 are left unchanged.
!edigout 5 1 set digital output 5 to logic 1 (high)
!edigout 7 0 set output 7 to 0 (low)
?edigout read the state of all outputs
?edigout 5 read the state of output 5

20.8. ediginpol (Multi I/O Digital Input Polarity)

Syntax: !ediginpol or ?ediginpol
Parameter: string of up to 12 characters 0 and 1,
or single bit access with input number 0 to 11 and state 0, 1

Availability: Multi-IO extension module on TANGO PCI-E/DT-E or Desktop 3HE.

Description: This instruction sets or reads back if the Multi I/O input signal inverters are activated or not. Each of the 12 inputs can be inverted individually.
The inverter may be set either by a string of levels (up to 12 0s and 1s) or by specifying the input number and inverter state. The string is LSB first (input 0 is the leftmost).

Response: currently applied inverter setting(s)

Examples:
!ediginpol 010000000000 Set all inverter states (IN1 to inverted)
!ediginpol 11000 The digital inputs IN0 and IN1 are set inverted, IN2, 3 and 4 are set to non inverted, input IN5 to IN11 settings are left unchanged
!ediginpol 5 1 activate inverter of digital input IN5 only
!ediginpol 7 0 disable inverter of digital input IN7 only
?ediginpol read the input inverter setting of all 12 inputs
?ediginpol 5 read the input inverter setting of input 5 only

20.9. edigintyp (Multi I/O Digital Input Type)

Syntax: !edigintyp or ?edigintyp
Parameter: string of up to 12 characters 0 and 1,
or single bit access with input number 0 to 11 and state 0, 1

Availability: Multi-IO extension module on TANGO PCI-E/DT-E or Desktop 3HE.

Remarks: 24 Volt configured Multi-IO only works with pull-down (0).

Description: This instruction sets or reads back if the Multi-IO pull-up / pull-down resistor settings for the 12 inputs. Each of the 12 resistors can be set individually.

0 = pull down
1 = pull up

The pull up/down may be set either by a string of levels (up to 12 0s and 1s) or by specifying the input number and level. The string is LSB first (input 0 is the leftmost).

Response: currently applied pull up/down setting(s)

Examples:
!edigintyp 110000000000 Set all pull up/downs (IN0, IN1 to pull up, rest down)
!edigintyp 001 Set IN0+IN1 to pull down, IN1 to pull up, rest left unchanged
!edigintyp 4 1 set IN4 to pull up
!edigintyp 2 0 set IN2 to pull down
?ediginpol read the pull up/down settings of all 12 inputs
?ediginpol 5 read the pull up/down setting of input 5 only

20.10. edigoutpreset (Multi I/O Digital Output Presets)

Syntax: !edigoutpreset or ?edigoutpreset
Parameter: string of up to 8 characters 0 and 1,
 or single bit access with output number 0 to 7 and state 0, 1

Availability: Multi-IO extension module on TANGO PCI-E/DT-E or Desktop 3HE.

Description: This instruction sets or reads back the logic levels of one or all digital outputs of the optional Multi I/O extension port, which are applied after power up of the TANGO. Output preset levels may be set either by a string of levels (up to eight 0s and 1s) or by output number and signal level. The string is LSB first (output 0 is the leftmost).

Response: output preset value(s)

Examples:

```
!edigoutpreset 11110000 After power on, the digital outputs 0,1,2,3 are set to
                        logic '1' and the outputs 4,5,6,7 are set to logic '0'
!edigoutpreset 100 After power on, the digital output 0 is set to logic '1' and
                    the outputs 1 and 2 are set to logic '0'. Outputs 3 to 7 are
                    left unchanged.
!edigoutpreset 5 1   set preset value of output 5 to logic 1 (high)
!edigoutpreset 7 0   set preset value of output 7 to 0 (low)
?edigoutpreset      read the state of all outputs
?edigoutpreset 5    read the state of output 5
```

20.11. edigrly (Multi I/O Relay Option Access)

Syntax: !edigrly or ?edigrly
Parameter: 0 or 1

Availability: Multi-IO extension module with installed relay option on a TANGO PCI-E/DT-E or Desktop 3HE.

Description: Switch the optional relay to

 1 = ON
 0 = OFF

Response: Relay ON/OFF state

Examples:

```
!edigrly 1           Switch relay to ON
?edigrly            read relay state (e.g returns 0)
```

20.12. adigin (AUX I/O Digital Input)

Syntax: ?adigin or adigin
Parameter: none or 0 to 3 or 4

Description: Read Digital inputs of the AUX I/O or AUX mini connector. Returns the logic state of one or all digital inputs on the AUX I/O or AUX mini connector. If no parameter is used, all inputs are returned as an ASCII character string of 0 or 1.

0 = Bit 0: AUX I/O Pin 1 (Takt In) **
1 = Bit 1: AUX I/O Pin 2 (V/R In)
2 = Bit 2: AUX I/O Pin 3 (Stop)
3 = Bit 3: AUX I/O Pin 4 (SnapShot2)
The 2nd gen. TANGOs, e.g. Desktop HE, adds:
4 = Bit 4: Motor Connector Pin 23 (TRIN1)

Remarks **: Bit 0 (Takt In) is not available with TANGO PCI-S and DT-S.

TANGO 3 mini: The TANGO 3 mini controller has a different bit assignment:
and 3 mini 22 at "configcompat=1"

0 = Bit 0: AUX mini Pin 1 (Takt In)
1 = Bit 1: Motor Connector Pin 7 (TrIn)
2 = Bit 2: not available (Dummy)
3 = Bit 3: AUX mini Pin 2 (SnapShot)

Response: Logic state of the digital input(s), LSB first (LSB->MSB)

Examples:

?adigin => 0111 read all AUX I/O digital inputs (here: "Takt In" is 0)
?adigin 3 => 1 read AUX I/O digital input 3 ("SnapShot2")

20.13. adigintyp (AUX I/O, AUX mini Digital Input Type)

Syntax: !adigintyp or ?adigintyp
Parameter: input bit: none or 0 to 3 or 4
and type : 0 or 1

Availability: With TANGO 3 mini and 2nd generation TANGOs except the I2.

Description: Select a pull-up or pull-down resistor for the digital inputs: 1 = pull-up (default), 0 = pull-down.

TANGO 3 mini: 0 = Bit 0 = AUX mini Pin 1 (Takt In)
and 3 mini 22 at 1 = Bit 1 = Motor Connector Pin 7 (TrIn)
"configcompat=1" 2 = Bit 2 = not available (Dummy)
3 = Bit 3 = AUX mini Pin 2 (SnapShot)

2nd gen. TANGOs: 0 = Bit 0: AUX I/O Pin 1 (Takt In)
1 = Bit 1: AUX I/O Pin 2 (V/R In)
2 = Bit 2: AUX I/O Pin 3 (Stop)
3 = Bit 3: AUX I/O Pin 4 (SnapShot2)
4 = Bit 4: Motor Connector Pin 23 (TRIN1)

Response: State(s) of the digital input pull-up/pull-down resistor(s)

Examples:

!adigintyp 0111 Set input 0 to pull-down, inputs 1,2 and 3 to pull-up
!adigintyp 1 0 Set input 1 to pull-down, other inputs remain unchanged
?adigintyp Read all digital input pull-up/downs (response e.g. 0011)
?adigintyp 3 Read pull-up/down setting of digital input 3 (e.g. 1)

20.14. adiginfunc (AUX I/O, AUX mini Digital Input Function)

Syntax: !adiginfunc or ?adiginfunc
 Parameter: input bit : none or 0 to 3 (or 0 to 4)
 and function: 0, 1 or 2

Availability: With TANGO 3 mini and all 2nd generation TANGOs.

Description: Assign a function to the digital inputs.

Input bits:

TANGO 3 mini: 0 = Bit 0 = AUX mini Pin 1 (Takt In) , default=0
 and 3 mini 22 at 1 = Bit 1 = Motor Connector Pin 7 (TrIn) , default=0
 "configcompat=1" 2 = Bit 2 = not available (Dummy) , default=0
 3 = Bit 3 = AUX mini Pin 2 (**SnapShot**) , **default=2**

2nd gen. TANGOs: 0 = Bit 0: AUX I/O Pin 1 (Takt In) , default=0
 1 = Bit 1: AUX I/O Pin 2 (V/R In) , default=0
 2 = Bit 2: AUX I/O Pin 3 (**Stop**) , **default=1**
 3 = Bit 3: AUX I/O Pin 4 (**SnapShot2**) , **default=2**
 4 = Bit 4: Motor Connector Pin 23 (TRIN1) , default=0

And function:

0 = input pin for **adigin** readout only
 1 = stop function (also refer to **stoppol** and **adigintyp**)
 2 = snapshot function (also refer to **sns1** and **adigintyp**)

The stop input function is a software stop. It can be set to a variety of behaviors as described in **stoppol**.

It is possible to assign the same function to several inputs.

By default, SnapShot is assigned to the SnapShot input and stop to the stop input (or for TANGO 3 mini: not assigned).

Response: Currently selected input pin function(s)

Remarks: If selecting a stop or snapshot function for one or several inputs, please ensure that the correct pull-up/pull-down resistor is set by **adiginfunc** and the correct polarity is chosen by **stoppol** or **sns1**.

When connecting the MW liquid dispenser to the AUX mini port, please ensure that the SnapShot function is assigned to the correct pin, else the **drop** counter will not work correctly.

Examples:

```
!adiginfunc 1 2      Set a single input by specifying bit and function, here:
                    Assign snapshot function (2) to input 1
!adiginfunc 0 1 0 2  Set all 4 input functions: input 0 as normal input (0),
                    input 1 as stop input (1), input 2 as input
                    and input 3 to snapshot function (2).
!adiginfunc -1      Reset all inputs to their default function
?adiginfunc → 0 0 1 2 Returns the function of all digital inputs
?adiginfunc 3 → 2   Returns the function of input 3 (here: SnapShot)
```

20.15. adigout (AUX I/O Digital Output)

Syntax: !adigout or ?adigout
Parameter: Set LSB or more bits at once: string of 0s and 1s,
 or single bit with two numbers: 0 to 3 and 0 or 1

Description: Available with the AUX I/O connector, this instruction sets
 or reads back the logic level of the AUX I/O digital outputs.
 Outputs may be set either by a string of levels (0s and 1s)
 or by individual bit number and signal level:

 0 = Bit 0: AUX I/O Pin 5 (TAKT_OUT, default LED100 on/off pin)
 1 = Bit 1: AUX I/O Pin 6 (VR_OUT)
 2 = Bit 2: AUX I/O Pin 7 (SHUTTER_OUT)
 3 = Bit 3: AUX I/O Pin 8 (TRIGGER_OUT)

 The string is LSB first (channel 0 is the leftmost).

TANGO 3 mini: 0 = Bit 0: AUX mini Pin 6 (TAKT_OUT, def. LED100 on/off pin)
 1 = Bit 1: AUX mini Pin 7 (VR_OUT)
 2 = Bit 2: AUX mini Pin 8 (SHUTTER_OUT)
 3 = Bit 3: AUX mini Pin 9 (TRIGGER_OUT)

Remarks: Some outputs might be occupied when the **trigger** is activated.
 Shutter out can be controlled by the **shutter** instruction also.
 In manual LED control mode (**hdimode** bit 2), TAKT_OUT will be
 set high/low automatically depending on brightness (0%=high).

Response: Output state(s), 0 or 1

Examples:

```
!adigout 1011   digital outputs 0,2,3 are set to high, output 1 is set to low
!adigout 10     digital outputs 0 and 1 are set: output 0 to high, 1 to low,
                  outputs 2 and 3 are left unchanged
!adigout 0     set digital output 0 to logic 0     (e.g. LED100 on )
!adigout 1     set digital output 0 to logic 1     (e.g. LED100 off)
!adigout 1 0   set digital output 1 to logic 0
!adigout 2 1   set digital output 2 to logic 1
?adigout       read back the level of all outputs (e.g. returns 0000)
?adigout 3     read back the level of output 3     (e.g. returns 0)
```

20.16. adigoutpreset (AUX I/O Digital Output Preset)

Syntax: !adigoutpreset or ?adigoutpreset
Parameter: Set LSB or more bits at once: string of 0s and 1s,
 or single bit with two numbers: 0 to 3 and 0 or 1

Availability: 2nd generation TANGOs except the I2.

Description: With a syntax same as the adigout instruction, adigoutpreset
 allows to specify the default power up state of the AUX I/O
 digital output pins of the TANGO Desktop HE.

 0 = Bit 0: AUX I/O Pin 5 (TAKT_OUT, default LED100 on/off pin)
 1 = Bit 1: AUX I/O Pin 6 (VR_OUT)
 2 = Bit 2: AUX I/O Pin 7 (SHUTTER_OUT)
 3 = Bit 3: AUX I/O Pin 8 (TRIGGER_OUT)

Response: Output state(s), 0 or 1

Examples: !adigoutpreset 1011

20.17. anain (Analogue Input)

Syntax: ?anain or anain
Parameter: c or v
Channel number, refer to **Appendix A**

Description: Read analog signal values. The channels and options depend on hardware and are different for each TANGO controller type. Channel 10 provides the AUX I/O analog input signal value. Most channel values are returned in 10-bit digits, 0 to 1024. While others offer monitoring of supply voltages, currents, temperatures or HDI values such as e.g. joystick deflection. Using "anain v" instead of "anain c" returns two additional fractional digits that increase the resolution if the TANGO provides a higher resolution ADC than 10 bits, e.g. 12 bits. If not available, "anain v" returns the same as "anain c".

Remarks: A complete anain channel list for each TANGO controller can be found in **Appendix A - anain options of different TANGOs**.

For monitoring the supply Voltage, Firmware 1.73 and higher offer direct readout of the supply Voltage ("motor voltage") through channel 28. In case of older Firmware versions, it can be calculated to Volts as follows:

- PCI-E, DT-E, TANGO mini, Pilot, TANGO 3 mini:
 $U_{\text{mot}}[\text{V}] = [\text{anain c } 12] * 0.05792$
- TANGO integrale:
 $U_{\text{mot}}[\text{V}] = [\text{anain c } 12] * 0.03545$
- TANGO PCI, PCI-S, DT, DT-S: (PCI-E, DT-E is compatible)
 $U_{\text{mot}}[\text{V}] = [\text{anain c } 12] * 29.63 / [\text{anain c } 15]$
- To calculate the internal PSE voltage:
 $U_{\text{pse}}[\text{V}] = [\text{anain c } 11] * 7.819 / [\text{anain c } 15]$

Example:
anain c 28 => 510 Read channel 10 (AUX I/O analogue input pin 9) as 10 bit
anain v 10 => 509.75 Read value with higher resolution, e.g. 12 bit



20.18. anaout (Analogue Output)

Syntax: !anaout or ?anaout
 Parameter: 0 to 100 in percent (for anaout values)
 c or p (c = single channel keyword, p for preset)
 0, 1 or 2 (single channel number, when using c or p)

Description: Sets or reads back the AUX I/O analog output signal level in percent. It can be accessed either directly or by specifying an individual channel with the 'c' keyword (refer to examples)

Power-on presets can be specified to provide a certain output voltage after switching on the controller. The functionality can be accessed by the 'p' keyword and stored permanently by using '**save**'.

The signal resolution is 14 bit (100%/16384) with PCI-E and PCI-S based TANGO controllers and the TANGO 3 mini. Fractional numbers can be used for higher resolution.

100% corresponds to 10 Volts (TANGO 3 mini: 5 Volts).

Channel	Connector	Signal Name	TANGO AUX I/O Pin	TANGO 3 mini AUX mini Pin
0	AUX I/O	ANOUT0	10	11
1	AUX I/O	ANOUT1	11	-
2	reserved	-	-	-

Instructions: !anaout [level of anaout0] [optional also level of anaout1]
 !anaout c [channel no.] [level of specified anaout channel]
 !anaout p [channel no.] [preset value of specified channel]

Remarks: Channel 0 is used for brightness control of the LED100 illumination. In order to entirely switch off the LED, use '**adigout**'. Also refer to manual LED control via **hdimode**.

In case of TANGO 3 mini the output voltage is 0~5 Volts and only one output is available: ANOUT0 at AUX mini pin 11. For compatibility, ANOUT1 is kept as a dummy value which remains at 0.00%.

Response: Analogue output signal level(s) in percent

Examples:

```
!anaout 100 50.08 Set channel 0 = 100% (10V) and channel 1 = 50.08% (5.008V)
!anaout 75.4      Set channel 0 = 75.4% (7.54V)
```

```
!anaout c 1 25.3 Set channel 1 to 25.3% (2.53V)
```

```
!anaout p 0 10 Set channel 0 power-on preset value to 10% (1 Volt)
save          Save the preset value permanently to the TANGO
```

```
?anaout       Read output level of all channels (e.g. 0.00 0.00 0.00)
?anaout c 0   Read output level of channel 0 only (e.g. returns 100.00)
```

20.19. anamode (Analogue I/O Modes)

Syntax: !anamode or ?anamode
Parameter: 0 to 5

Availability: 2nd generation TANGOs or TANGO PCI-S/DT-S, PCI-E/DT-E with the optional AUX I/O connector installed. TANGO 3 mini partly.

Description: Defines the behavior of the optional analog IO, available with the AUX I/O connector.

```
0 : default mode - output controlled by '!anaout'  
    or by HDI devices in LED100 mode (hdimode)  
1 : ANOUT0 controled by anain          (0~5Vin → 0~10Vout)  
2 : ANOUT1 controled by anain          (0~5Vin → 0~10Vout)  
3 : ANOUT1 controled by Z-axis position (0~10V out, 14bit)  
4 : ANOUT1 controled by A-axis position (0~10V out, 14bit)  
5 : Z-axis is controlled by ANIN and TAKT_IN ("OLAF mode")
```

TANGO 3 mini: TANGO 3 mini supports anamodes 0 and 3 only.
The 14bit output voltage range is 0~5 Volts.

Remarks: In anamode 3 and 4, do not use a stepper motor on the axis.

TANGO Firmware differences concerning anamodes:

```
-----  
- Before 1.69 : the TANGO does not store the anamode.  
    Anamodes different from 0 must be set  
    each time after power up or reset.  
  
- 1.72 to 1.78: anamode 3 and 4:  
    due to introducing calmode 5 functionality  
    a voltage offset on the analog output  
    (pos 0 is not 0 Volts) can occur.  
    Workaround would be to disable the support  
    of calmode 5 by "!configcurvector 0" + save.  
  
- From 1.79 on: anamode 3 and 4:  
    No impact of calmode 5 anymore, 0 is 0 Volts.  
    Also, no limits must be defined, the TANGO  
    sets the limits accordingly at power up.
```

```
-----  
--> refer to the "Anamode description with examples"  
    on the next page
```

Response: Selected mode as integer

Examples: !anamode 3 (set mode 3 to drive analog piezo stage with Z)
?anamode => 3

Anamode description with examples:**Anamode 3 or 4 - Controlling a Piezo Z-Stage**

In anamodes 3 or 4, the analog output ANOUT1 follows the Z or A axis position. It is possible to control a piezo stage through the 0-10 Volts output signal on the AUX I/O port, instead of having a stepper motor on the motor connector.

The 0-10 Volts output ANOUT1 then corresponds to the absolute piezo position.

The spindle **pitch** must be set to achieve the required travel of the piezo axis.

Example of a 0...10V piezo stage which travels 0.3mm at 10 Volts input signal:
(For anamode 4, replace "z" of the example by "a" and set "!anamode 4".)

```
!pitch z [stage travel in mm @ 10V]*12.5      (e.g. 0.3mm*12.5 = !pitch z 3.75)
!lim z 0 [stage travel *** @ 10V]           (e.g.                !lim z 0 0.3 )
!anamode 3
```

*** The example shows mm dim 2 or 9, but it works with any dim setting. Ensure that the upper lim value is set in the corresponding dim unit, e.g. 300 for μm .

TANGO firmware 1.79 and higher has an improved support of the anamodes 3 and 4. Set the pitch accordingly as shown above, set the anamode, save it and restart the TANGO. From then on, the axis limits will automatically be set at power on or reset, which makes anamode 3 a standalone functionality even without a PC:

Now the 10 Volts output corresponds to pos z = 0.3mm and the axis can travel between the absolute positions 0.0 and 0.3 mm. The TANGO move instructions can be used, e.g. **moa**, **mor**, **speed** or **sp**, **go** etc. - or manually by the HDI.

Velocity and acceleration can be adjusted if required.

Please do not connect a stepper motor to the corresponding piezo axis Z or A.

TANGO 3 mini limitations

TANGO 3 mini has a 0-5V analog output signal. This signal either must be amplified externally to 0-10V or the travel range will be limited to 50% of the usual 0-10V range. In this case, the pitch for Z must be doubled to achieve the correct travel distance within 0-5V.

Anamode 5 is a special mode that works in conjunction with a laser autofocus:

Available from Firmware 1.73.

The anamode 5 can not be saved. It must be enabled by "!anamode 5" each time to ensure to start from a know state (the laser is switched on, connected, and ready for operation).

The laser autofocus here delivers an analog signal of [0.0 ... 2.5 ... 5.0]V, where 2.5V means "in focus" (converted by adapter cable No. 00-76-700-9822).

The Z-axis will travel in a constant loop to keep the input voltage at 2.5V as long as the digital "signal valid" information on the AUX I/O "TAKT IN" is at a logic 1 (high).

20.20. stoppol (Mode and Polarity of Stop Input Signal)

Syntax: !stoppol or ?stoppol

Parameter: 0 to 5 or 8 to 13

Description: Operating mode of the AUX I/O "Stop" input.
Signal polarity and behavior of the TANGO can be set:

0,1 Stop only as long as stop signal is applied

HDI (joystick) remains active!

0=active low, 1=active high

2,3 Stop only as long as stop signal is applied

HDI (joystick) is also disabled

2=active low, 3=active high

4,5 Stop signal is latched (sticky) released by "!stop 0" only

HDI (joystick) is also disabled

4=active low, 5=active high

6,7 Not available

8,9 Same as 0,1 but a running move will be completed first *

10,11 Same as 2,3 but a running move will be completed first *

12,13 Same as 4,5 but a running move will be completed first *

Modes 16 and 17 by TANGO Desktop HE only:

16,17 Only disable HDI (joystick) while stop signal is present

16=active low, 17=active high

Requirements: A stop signal must be applied for at least 50µs.

***) Stoppol modes 8-13 (all, including the latched modes):**

In order to stop, the stop signal must remain active until all axes have completed their currently running move instruction. If the stop signal is removed while an axis is still traveling, no stop will be performed.

TANGO 3 mini: Has no dedicated stop input. It can be assigned by **adiginfunc**.

Remarks: Usually the stop input has an internal pull-up resistor to +5V, while TANGO 3 mini and the 2nd gen. TANGOs Desktop HE and PCIE offer additional **adigintyp** and **adiginfunc** options. **adiginfunc 0** can be used to disable the stop functionality.

If closed loop 'ctrsm' mode is set to 4, an error condition of the closed loop will modify the stoppol to a latched mode by internally oring the current stoppol with 4 (0→4 etc.).

Sending "**!stop 1**" in latched stop modes immediately applies a stop, even in modes 10-13.

TANGOs without a stop input may use the latched stoppol modes in conjunction with manually sending "**!stop 1**" and "**!stop 0**".

Response: Operating mode of AUX I/O stop signal input as integer

Example:

```
!stoppol 5      Set the AUX I/O stop input to latched stop active high.
!stoppol 13     Same as above, but a currently running move is completed
                first and only the following moves will be suppressed.
?stoppol => 0    Current stoppol mode is mode 0 (default)
```

20.21. stop (Release, Force or Check Stop Condition)

Syntax: !`stop` or `?stop`
Parameter: 0, 1

Description: Release or force a stop condition in latched '`stoppol`' modes 4, 5, 12 and 13. Or read if stop condition is active.

0 = Release stop condition (in `stoppol` modes 4,5,12,13)
1 = Force stop condition (in `stoppol` modes 4,5,12,13 only)

Remarks: in `stoppol` modes 12 and 13, a forced stop by sending "`!stop 1`" stops the axes immediately (same as in `stoppol` modes 4,5).

Response: Internal stop state of the controller (0, 1)

Example: !`stop 0` release a latched stop
 !`stop 1` force a stop (in latched `stoppol` modes only)
 ?`stop` => 1 read if stop is currently active (=1)

20.22. stopl (Latched AUX I/O-caused Stop Condition)

Syntax: ?`stopl` or `!stopl`
Parameter: 0, 1

Availability: 2nd generation TANGOs (e.g. Desktop HE).

Description: Latched AUX I/O stop condition (not if caused by "`!stop`"). To check if a stop condition was active due to the stop input. Can be used if e.g. a move ended or instant closed loop did not switch on because there was a (temporary) external stop condition which might not be active anymore.

The latched state can be cleared by "`!stopl 0`".

Response: Latched stop state from the AUX I/O stop input signal.

Example: !`stopl 0` clear the stop latch to 0
 !`stopl 1` set the stop latch (makes no sense)
 ?`stopl` read if a stop condition was caused from AUX I/O

20.23. shutter (Shutter Out Signal of AUX I/O)

Syntax: !`shutter` or `?shutter`
Parameter: 0, 1

Description: Set the AUX I/O shutter out signal to the desired TTL level:

0 = signal low
1 = signal high

Response: Output level of shutter signal

Example: !`shutter 1` Set the shutter out signal to TTL high state

20.24. flash (Defined Pulse at AUX I/O Takt Out)

Syntax: flash or !flash

Parameter: +-0.00001 ... 32500 [ms]

Availability: TANGO PCI-S/DT-S, PCI-E/DT-E TANGO 3 mini and 2nd generation TANGOs with AUX I/O or AUX mini.

Description: Sends a pulse of defined length to the AUX I/O TAKT_OUT pin. Used e.g. for LED strobes.

Floatingpoint numbers in [ms].
Range 0.00001 (10ns) to 32500 (32.5s).
Resolution is 1/132 μ s.

Pulse Polarity depends on sign:

- Positive numbers generate an active high pulse
- negative numbers generate an active low pulse

For safe operation it is recommended to once send one dummy pulse when initializing in order have the correct polarity.

Remarks: Might interfere with secondary trigger output (see **trigo**).

Response: None

Example:

flash 0.001 (high pulse with duration of 1 μ s)
flash -0.01 (low pulse with duration of 10 μ s)

20.25. tvr (Pulse and Direction Input Function)

Syntax: !tvr or ?tvr
Parameter: x, y, z, a or none
 0, 5

Availability: TANGO PCI-E, DT-E and 2nd generation TANGOs with AUX I/O.

Description: Set the TVR Mode, used to drive an axis through an external pulse and direction signal via AUX I/O. For more details on the tvr input, please refer to Chapter 20: **Digital and Analogue I/O**.

0 = disabled
(1) = ~~enabled without tvrf factor~~
(2) = ~~enabled with tvrf factor~~
(3) = ~~enabled without tvrf factor, requires ext. start/stop~~
(4) = ~~enabled with tvrf factor, requires ext. start/stop~~
5 = enabled with **tvrjoyf** factor

Remarks: Aside the tvr, tvrjoy and tvrjoyf settings, the joy and joydir must be enabled for the tvr axis. It is not required for 2nd generation TANGOs (e.g. Desktop HE).

Response: Currently selected tvr mode(s)

Example:
!tvr 0 0 0 0 (disable tvr on all 4 axes)
!tvr z 5 (enable tvr mode 5 for Z axis)
?tvr z => 5 (read tvr mode of Z axis)
?tvr => 0 0 5 0 (read tvr mode of all axes)

Example for TVR via AUX I/O standalone operation:

!tvrjoyf 1.0 (Assign a factor of 1, about 1/1000 motor rev. per pulse)
!tvr z 5 (Enter tvr mode 5 in Z)
!tvrjoy z (Assign tvr to the Z-axis)



20.26. brake (Axis Brake Function)

Syntax: !brake or ?brake
 Parameter: x, y, z, a or none
 0,1...8 or 255...0 (I IO Brake) and 0 or 1 (Onboard Brake)

Availability: TANGO PCI-E/Desktop-E, 3 mini, several 2nd generation TANGOs. The availability of the brake function depends on order.
A) The **TANGO PCI-E/Desktop-E** provides a brake function via optional IO1 or Multi-IO extension module outputs OUT0-7.
B) The **TANGO 3 mini** and the **2nd gen. PCIE** have one brake pin on their motor connector. The brake instruction syntax is identical, except only having 0 or 1 ("OUT0").
C) The **TANGO Desktop HE** allows both, either a sophisticated onboard brake over a motor connector pin or a brake via IO1 and Multi-IO extension modules, for compatibility to existing PCI-E/Desktop-E applications or several brakes. **

Description: Function for electrically released brakes, intended to hold axes if their motor loses its torque (due to switched off axes, amplifiers, undervoltage, PSE or current reduction).

Motor torque is on : Output = high (24V to release brake)
 Motor torque is off: Output = low (0V, brake closes)

From TANGO Firmware 1.70, a motor **current reduction** to <30% also leads to activating the brake. Also, when ramping up a current after power-on, the brake is released from >=30%. Setting a low '**cur**' value does not activate the brake.

As output "low" is the safe brake state, when sharing outputs with several axes the output state zero is dominant.

IO Brake: Individual, combined, or shared IO outputs can be selected for each axis.

Each axis can be applied to an output by integer values 1~8. Negative values can be used to apply several output pins or combine/share pins - even with other axes. They represent a bit mask of 8 bit (0x00~0xFF) as integer values 0 to -255.

I/O:	[OUT7]	[OUT6]	[OUT5]	[OUT4]	[OUT3]	[OUT2]	[OUT1]	[OUT0]
PIN:	8	7	6	5	4	3	2	1
BIT:	-128	-64	-32	-16	-8	-4	-2	-1

- 0 = brake function disabled (default)
- 1 = apply brake to 1st IO pin (OUT0) *PIN specified*
- 2 = apply brake to 2nd IO pin (OUT1) *PIN specified*
- 3,4,5,6,7 ... (OI,3,4,5,6) ...
- 8 = apply brake to 8th IO pin (OUT7) *PIN specified*
- 1 = apply brake to 1st IO pin (OUT0) *BIT specified*
- 2 = apply brake to 2nd IO pin (OUT1) *BIT specified*
- etc. ...
- 17 = apply brake to 1st and 5th pin (OUT0 + OUT4) *BITs*

If the TANGO provides both IO1 and Multi-IO extension modules, the Multi-IO is used for the brake functionality.

The assigned pins cannot be accessed by IO write instructions **!digout**, **!edigout**. But reading the digital output state with **?digout**, **?edigout** does return the state of the brake output.



Onboard Brake: TANGO 3 mini, 2nd gen. PICE and TANGO Desktop HE can be ordered with an onboard brake that provides a (24V) brake signal via the Axis 1-3 motor connector, the Desktop HE also on Axis 4. There is only one output available. It can be assigned to one or multiple axes.
TANGO Desktop HE provides a brake module, where the brake voltage for activating and holding the brake and the delay between it can be configured via '**vbrake**' and '**brakedelay**'.
"?brake 1" reads the state of the onboard brake output.
Here: 1=brake active (closed), 0=brake inactive (open).

Important note: **TANGO Desktop HE requires the brake to be configured, as it provides both options - the I/O module brake like Desktop-E and PCI-E and the adjustable onboard brake.
There, '!configbrake 1' enables the onboard brake function, and '!configbrake 2' enables the compatible I/O module brake. By default, configbrake is set to 0 = brake function disabled and so setting of "!brake" has no effect.

Response: Integer value(s), 0 or -255 to 8 (Onboard Brake: 0s or 1s)

Examples:

```
!brake z 1          Enable brake for Z axis on OUT0 or Onboard Brake
!brake 0 0 1       Enable brake for Z axis on OUT0 or Onboard Brake

!brake 1 3 8 0     Enable brakes for XYZ axes on different IO-pins, disable A
!brake 4           Enable brake for X axis on 4th IO-pin (OUT3)
!brake -17 -18 -20 Enable brake for XYZ on IO-pins 123, create XYZ common pin 5

?brake            Read brake setting for all axes (e.g. returns 0 0 0)
?brake z         Read brake setting for Z axis only (e.g. returns 0)

?brake 1 => 0     Read the state of the Onboard Brake (here: inactive/open)
!brake z         Assign the Onboard Brake to only Z (others will be removed)
```

20.27. vbrake (Axis Brake Voltage)

Syntax: !vbrake or ?vbrake
Parameter: 4.0...24.0 Volt (to open)
4.0...24.0 Volt (to hold open, optional 2nd parameter)

Availability: 2nd generation TANGOs with installed Onboard Brake only.

Description: Set the voltages for opening and for holding the brake open. The default setting is 24V for both, opening and holding.

When using one parameter, it applies to both, open and hold.

The time delay between opening and holding voltage can be adjusted by !brakedelay.

As the usual brake state is "open" (powered), the brake introduces heat into the system. The heating can be reduced by lowering the brake holding voltage. Possibly also the opening voltage can be reduced or has to be in case not 24V. Similar to motor current reduction, lowering the brake hold voltage to 70% would reduce power and heat to ½ (50%). Please refer to the brake data sheet to ensure safe function.

Remarks: The minimum voltages (of an individual brake) can be found by

- setting "!vbrake 4" (minimum voltages)
- activating the brake, e.g. by "!brake x" (so it would open)
- increase "!vbrake 5", 6, ... until the brake opens (e.g. 16)
- reduce !vbrake again until the brake closes (e.g. 10)
- now the absolute minimum voltages are known (here 16 and 10)
- probably decide to set "!vbrake 22 14"

Response: Currently selected vbrake voltages (for opening and holding)

Example: !vbrake 24
?vbrake => 24.0 24.0
!vbrake 22 12.0
?vbrake => 22.0 12.0
?vbrake 1 => 12.1 (currently measured brake voltage)
?vbrake 2 => 9.8 (monitoring V.level for open brake)

20.28. brakedelay (Axis Brake Hold Voltage Delay)

Syntax: !brakedelay or ?brakedelay
Parameter: 1 ... 10000 [ms]

Availability: 2nd generation TANGOs with installed Onboard Brake only.

Description: Time delay before applying the hold voltage to the brake. Allows the brake to safely open with the opening voltage before switching to the (lower) hold voltage (see **vbrake**). The default value of 100ms should be sufficient for most brakes, please refer to the brake data sheet.

Response: Delay time in ms between opening and reducing to hold voltage

Example: !brakedelay 30
?brakedelay => 30

20.29. brakemode (Axis Brake when Idle)

Syntax: !brakemode or ?brakemode

Parameter: 0, 1

Availability: 2nd generation TANGOs with Onboard Brake from Firmware 1.78.

Description: An activated brakemode causes the onboard brake to close when the axis is idle. If the axis is started by a move, speed, cal, etc. instruction or by HDI (e.g., Joystick), the brake opens and after the brakelay, the axis starts the move. Afterwards, the brake closes again. This mode can be used, where the axis must be held in position even on power loss.

0 = normal mode (default)

1 = brake mode enabled

Remarks: Brakemode does not apply to brakes realized with the IO1/IO2.

Response: 0 or 1

Example: !brakemode 1
?brakemode => 1

20.30. brakepos (Move to Initial Motor Pole Position)

Syntax: !brakepos or brakepos

Parameter: x, y, z or a
1, -1 or none

Availability: TANGO PCI-E/Desktop-E, TANGO 3 mini, 2nd generation TANGOs running firmware 1.70 or higher.

Description: Drives the motor to the nearest motor pole, which also is the initial position after a power-on or reset of the TANGO.

If brakepos is executed before power down or before activating the motor brake, it avoids a "jump" of the motor at power up. This jump can be within ± 2 motor steps, depending on where the axis was positioned before.

While this jump usually is not an issue, it can cause a problem on Z-axes with heavy load: When the **brake** is released, this jump, under certain conditions, can cause the motor to stall and the axis then runs down until its mechanical limit.

So for heavy loaded Z-axes with attached motor **brake**, the brakepos instruction can be used to prevent the axis from running down at power-up (when the **brake** is released).

The brakepos instruction can only be executed for individual axes, so the axis specifier **x,y,z or a is required**.

There also is an **optional parameter** 1, -1 or none, which can be used to specify the travel direction in which brakepos is executed:

[none] = positions the motor to the nearest pole
positive or negative rotation **

1 = positions the motor to the next pole
in positive direction **

-1 = positions the motor to the next pole
in negative direction **

** The parameter can be used to ensure the axis is traveling forward (or backward) only, to avoid possible collisions.

If the axis is standing within a limit switch, the direction is set to "out of the switch" automatically, independent of the direction parameter.

The normal axis **velocity** and **acceleration** is used. For a typical motor with 200 steps, the travelled distance is less than $4/200 = 0.02$ revolutions or 7.2 degrees.

Response: none (but brakepos blocks all following instructions until the move is completed, usually within milliseconds)

Examples:

brakepos z => Travel to the nearest motor pole in Z

brakepos z 1 => Travel forward to the next motor pole in Z...
?err => and wait for executipon by using the ?err reply

brakepos z -1 => Travel backward to the next motor pole in Z...
!pa 0 => then turn off the amplifiers without waiting, as brakepos blocks the !pa 0 instruction until brakepos is reached.

20.31. drop (Liquid Dispenser – Generate Drops)

Syntax: !drop or ?drop
Parameter: 0, 1, ... 6000

Availability: TANGO PCI-E, TANGO DT-E, TANGO 3 mini and 2nd generation TANGOs with AUX I/O or AUX mini.

Description: Used with the Märzhäuser Liquid Dispenser.
Generates drops or reads back the amount of generated drops.

The instruction supports two dispenser types:

1) For upright microscopes

Drops are generated and counted.

2) For inverted microscopes

Liquid is dispensed for the specified amount of seconds or 1/10 seconds (depends on dispenser setup). Time is counted.

!drop 0 resets the counter to zero

!drop N generates *N* drops (or *N* seconds), *N*=1...6000

?drop 0 reads amount of drops still to be generated by the recent !drop instruction, this countdown can be used to identify the drop instruction has finished (=0). Here it's not required to reset the counter.

?drop reads amount of drops/time since counter was resetted

Remarks: Might interfere with trigger and snapshot functionality.

TANGO 3 mini: The drop counter is connected to the AUX I/O SnapShot input. In case of TANGO 3 mini, the snapshot pin assigned by **adiginfunc** is used.

Response: Amount of counted drops or time, depending on the device. The drop counter counts to a maximum of 65535 then rolls over.

Example:
!drop 10 generate 10 drops, or dispense liquid for 10 seconds, (depends on hardware)

?drop 0 => 7 (still 7 drops or seconds remaining, not finished yet)

?drop 0 => 0 (all drops have been generated, ready)

!drop 0 reset the drop counter for ?drop

?drop read the drop counter (counting since it has been resetted)

20.32. pump (Liquid Dispenser – Manually Add Air Pressure)

Syntax: !pump or ?pump

Parameter: 0, 1

Availability: TANGO PCI-E, TANGO DT-E, TANGO 3 mini and 2nd generation TANGOs with AUX I/O or AUX mini.

Description: Used with the Märzhäuser Liquid Dispenser. Manually overwrites the air pressure pump. Can be used to ensure sufficient pressure before dispensing liquids in inverted applications (time interval mode). The dispenser switches the pump on and off automatically, but in case of the time interval dispenser it might be safer to ensure sufficient pressure before dispensing by this instruction. For generating drops, it might not be required to ensure pressure because they are counted. It then just may take longer.

1 = Air pressure pump on

0 = Air pressure pump off

It is ensured by design that the maximum pressure won't be exceeded.

Remarks: Might interfere with trigger and snapshot functionality.

Response: 0 (pump is off), 1 (pump is on)

Example:
!pump 1 switch pump on
!pump 0 switch pump off
?pump => 0 (pump is off)

20.33. vbus (+24V Supply Output On/Off)

Syntax: !vbus or ?vbus
Parameter: 0, 1

Availability: Only with TANGO 3 mini and 2nd generation TANGOs providing a 24V output on the CAN connector or AUX mini port.

Description: On/off state of the +24V power output.
A 24V supply can be provided for external components.
For TANGO 3 mini, the +24V is output on the AUX mini port,
For TANGO Desktop HE it is output from the CAN Bus connector.

1 = +24V on
0 = +24V off

Remarks: After power up or reset, the +24V is not provided on the AUX mini connector by default. It must be switched on by !vbus or configured to always on by 'configvbus'.

Response: 0 (+24V is off) or 1 (+24V is on)

Example:
!vbus 1 switch +24V on
!vbus 0 switch +24V off
?vbus => 0 Read on/off state (here: +24V is off)

20.34. configvbus (+24V Supply Output Preset)

Syntax: !configvbus or ?configvbus
Parameter: 0, 1

Availability: Only with TANGO 3 mini and 2nd generation TANGOs providing a 24V output on the CAN connector or AUX mini port.

Description: Sets the default state of the +24V supply output after power up or reset.
A 24V supply can be provided for external components.
For TANGO 3 mini, the +24V is output on the AUX mini port,
For TANGO Desktop HE it is output from the CAN Bus connector.

1 = +24V on after power up
0 = +24V off after power up (default)

Remarks: The +24V pin might not be powered by default. To change this, configvbus can be used. The +24V can also be switched on and off temporarily during operation by the 'vbus' instruction. The momentary on/off state can be checked by '?vbus'.

Warning: It is not recommended to plug or unplug the AUX mini connector when the 24V is on. It could lead to damage of 5V electronics or of the RS232-Tx driver. This is why configvbus is set to 0 by default.

Response: 0 or 1

Example:
!configvbus 1 +24V on after power up (and +24V is immediately switched on)
!configvbus 0 +24V off after power up (+24V is not immediately switched off)
?configvbus => 0 (+24V is configured to off)

20.35. configcanres (USB Host +5V Supply Output Preset)

Syntax: !configcanres or ?configcanres
Parameter: 0, 1

Availability: 2nd generation TANGOs with CAN connector except the TANGO-I2.

Description: Optional activation of the onboard can terminating resistor.

0 = 120Ω termination off (default)
1 = 120Ω termination on

Response: 0 or 1

Example:

```
!configcanres 1          Enable onboard CAN Bus termination (120Ω load)
!configcanres 0          Disable onboard CAN Bus termination
?configcanres            => 0  Read CAN termination state (here: 0 = off/disabled)
```

20.36. vusb (USB Host +5V Supply Output On/Off)

Syntax: ~~!vusb~~ or ?vusb
Parameter: 0, 1

Availability: Only with TANGO Desktop HE.

Description: On/off state of the 5V power output of the USB Host interface.

1 = +5V on (default)
0 = +5V off

Remarks: The 5V is of the USB Host (USB-A) switched on by default.
~~The default behavior can be changed by 'configvusb'.~~

Response: 0 (+5V is off) or 1 (+5V is on)

Example:

```
!vusb 1          switch +5V on The presence of 5V is handled by the USB Host.
!vusb 0          switch +5V off The presence of 5V is handled by the USB Host.
?vusb           => 0  Read on/off state (here: +5V is off)
```

20.37. configvusb (USB Host +5V Supply Output Preset)

Syntax: !configvusb or ?configvusb
Parameter: 0, 1

Availability: Only with TANGO Desktop HE.

Description: ~~On/off state of the 5V power output of the USB Host interface after power up or reset.~~

The presence of 5V is handled by the USB Host, not by command.
1 = +5V on (default)
0 = +5V off

Response: 0 (+5V is off after power up) or 1 (+5V is on after powwe up)

Example:

```
!configvusb 1          Set power up default for the USB Host +5V to ON
?configvusb           => 1  Read power up default for the USB Host (here: +5V ON)
```

21. Encoder Instructions

The encoder interface supports incremental 1Vpp, 5Vpp MR and RS422-TTL encoders. The encoder type can be selected by the **enctype** instruction. Most TANGO encoder interfaces support reference marks (except TANGO mini 2-axis). TANGO Desktop HE controllers additionally support **absolute encoders** with BiSS-C or SSI interface and optional 1Vpp analog signal.

(Please also refer to the encoder interface description of the TANGO controller for further information: TANGO mini 2-axis and TANGO integrale have limitations in travel velocity when using 1Vpp or RS422 TTL encoder signals. For RS422 TTL, those even require a hardware change. Single ended TTL encoders always require additional circuitry.)

To enable encoder functionality, the encoder mask **encmask** must be set for the corresponding axes. If **encmask** is set, the encoders are activated after calibration **cal** or at power-up, depending on the selected **calmode**. This also enables the selected Closed Loop mode, which is set by **ctr**.

calmode also offers mode 3, which only reads out measuring systems without using them for the axis or closed loop (stand-alone measuring axis).

The **enc** state is internally set to 1 when the encoders are activated. Manually setting the encoders **enc** state to 1 is not recommended, as it might cause unpredictable behavior in closed loop mode (due to counting direction, position alignment, signal validation the TANGO controller applies internally). Also, in case of analog MR encoders, the signal correction will not be applied, which leads to positioning errors.

Reference marks can be activated by **encref**, the search velocity sets **encrefvel**.

Encoders that provide an active low error signal can be supported by **encnas**.

21.1. encmask (Encoder Mask)

Syntax: !encmask or ?encmask
Parameter: x, y, z, a or none
 0 or 1

Description: Reads or sets the encoder globally enable mask, which is required to activate the encoders (**enc**→1).

The encoders then will be detected and activated after

- A) a successful calibration instruction '**cal**'
 or
- B) after power up, when **calmode** 2 or 1 is selected

0 = clear enable mask (encoder will be ignored, not activated)
1 = set enable mask (TANGO will try to activate the encoder)

Response: Encoder enable mask as 0s and 1s

Example:
!encmask 1 1 0 Globally enable encoders for X, Y and disable Z-axis
!encmask z 0 Globally disable encoder for Z-axis
?encmask Read encoder mask state of all axes (e.g. 1 1 0)

21.2. enc (Encoder Active)

Syntax: ?enc (or !enc)
Parameter: x, y, z, a or none
 0 or 1

Description: Query if the encoders are active (successfully activated by a **cal** instruction or at power up in **calmode** 2, 1 or 4). **enc** is activated by the TANGO through **cal** or the calmodes. It is not recommended to manually activate the encoders by sending a "!enc 1" instruction, because the counting direction might be wrong and because some encoders (as MR 5Vpp) require a dedicated calibration procedure or signal check. For error free Closed Loop behavior and best measuring accuracy, encoders must be activated by the TANGO controller. This depends on **calmode**, **cal** and **encmask**. Please refer to the above-mentioned instructions and to the remarks below.

0 = Encoder is inactive (not used)
1 = Encoder is active (used)

Response: Encoder active state

Example:
?enc Read encoder active state of all axes (e.g. 1 1 0 for 3 axes)
?enc y Read encoder active state of Y-axis
!enc z 0 Disable encoder of Z-axis
!enc 1 1 0 (Manually activate encoders of X, Y and disable Z-axis) **
!enc x 1 (Manually activate the X-axis encoder) **

Remarks: ** Manual activation of the encoders (by !enc 1) is not recommended. In general, this is not recommended if the axis runs in closed loop. In case of MR encoders a special calibration procedure has to be performed, which is only available by !cal or instant closed loop (**calmode** 2 or 1). An exception can be if the axis is only used for measuring purposes and a TTL or 1Vpp encoder is attached (no MR).

If the application requires to disable and enable the encoders during operation (e.g. !enc 0 0 ... !enc 1 1), it is possible to check if the encoder once was successfully activated by cal or instant closed loop - even if it is now set to zero: ?enc 1 / ?enc x 1 will return a 1 if the encoders once were activated by cal or instant closed loop and no error I. This option is available since firmware 1.71.

Examples:

```
[power on or reset]
?enc => 0 0        (the encoders are off, not activated)
?enc 1 => 0 0     (encoders never were successfully activated)
```

```
[power on or reset]
!cal x => A@--.    (here: the X-encoder gets activated by cal)
?enc   => 1 0     (the X-encoder is on)
?enc 1 => 1 0     (the encoder has been activated (by cal))
!enc 0 0         (the application forces the encoders off)
?enc   => 0 0     (the encoders are off)
?enc 1 => 1 0     (the X-encoder once was activated (by cal))
!enc x 1         (it is okay to manually switch it on again)
?enc   => 1 0     (the X-encoder is on again)
```

21.3. encperiod (Encoder Signal Period)

Syntax: !encperiod or ?encperiod
Parameter: x, y, z, a or none
0.000002 to 4.0 [mm]

Description: This instruction reads or sets the encoder signal period.
The unit is always [mm].

Optional read-resolution: As an option to read the parameter with higher precision, the number of required decimal places can be specified with the query "?encperiod [0...16 decimal places]". If no precision is defined, the default resolution is 4 decimal places.

For rotational axes or turntables, encperiod is calculated as pitch/linecount if the rotary encoder is mounted on the table. If the encoder is on the motor, this value must be divided by the gear ratio.

Remarks: TTL encoders with large encoder periods of 0.1mm and higher will not be activated for closed loop operation.

Response: Encoder signal period(s)

Example:

```
!encperiod 0.5 0.5 0.001    Set encoder period for X and Y to 500µm, Z to 1µm
!encperiod z 0.02          Set encoder period of Z-axis to 20µm
!encperiod 0.00001960784   Set encoder period of X-axis
?encperiod                 Read encoder period of all axes
?encperiod z              Read encoder period of Z-axis
?encperiod 12             Read period of all axes with 12 fractional digits
?encperiod z 9            Read period of Z-axis with 9 fractional digits
```

21.4. encdir (Encoder Counting Direction)

Syntax: !encdir cdir or ?encdir
Parameter: x, y, z, a or none
0 or 1

Remarks: **Setting the encoder direction is not required and should never be changed by this instruction**, as the TANGO identifies the correct counting direction itself.
The only exception might be if the connected encoder is used as an independent measuring system (**calmode** 3).

Description: Set or read the encoder counting direction.
Do not set this parameter when the TANGO is in closed loop!
The encoder direction is set by the TANGO automatically (e.g. after calibration **cal** or instant closed loop during power-on).

0 = Encoder counting direction default
1 = Encoder counting direction reversed

Response: Encoder counting direction

Example:

```
!encdir 1 1 1             Reverse encoder counting direction for all axes
!encdir x 1              Reverse encoder counting direction for X-axis
?encdir                  Read encoder counting direction of all axes
?encdir y                Read encoder counting direction of Y-axis only
```

21.5. encsearchdir (Encoder Search Direction)

Syntax: !encsearchdir cdir or ? encsearchdir

Parameter: x, y, z, a or none
0 or 1

Availability: Older firmware versions only, until TANGO firmware \leq 1.68.

Description: Wiggle direction for encoder activation in **calmode** 1+2.

To activate the encoders, calmodes 1 and 2 perform the instant closed loop activation at power on. Therefore, the axis moves up to lmm (in case of MR) forward and back. In some axes, e.g. a Z-axis with MR, this can cause a collision (e.g. of the objective). Setting the encsearchdir of the axis to 1 reverses the Wiggle, so the first move travels in negative direction.

The default (0) is

Do not set this parameter when the TANGO is in closed loop!

The encoder direction is set by the TANGO automatically (e.g. after calibration **cal** or instant closed loop during power-on).

0 = Encoder search direction default (+,- wiggle)

1 = Encoder search direction reversed (-,+ wiggle)

Response: Encoder search direction(s)

Example:

```
!encsearchdir 1 1 1    Reverse calmode 1+2 encoder search direction for X,Y,Z
!encsearchdir z 1     Reverse calmode 1+2 encoder search direction for Z
?encsearchdir         Read encoder search direction of all xes
?encsearchdir z       Read encoder search direction of Z-axis only
```

21.6. **encvel (Encoder Auto-Ajust Velocity)**

Syntax: `!encvel` or `?encvel`
Parameter: `x, y, z, a` or none
`0.01 ... 20.0` [mm/s]

Description: The velocity for encoder auto-calibration can be set or read by this instruction. It is recommended to keep the default setting. The unit is always [mm/s].

Response: Velocity used for Encoder detection and calibration in [mm/s]

Example:

```
!encvel 0.5 0.5 0.5    Set encoder auto-adjust velocity for all axes
!encvel 0.5           Set encoder auto-adjust velocity for X-axis only
!encvel z 0.5        Set encoder auto-adjust velocity for Z-axis only
?encvel              Read encoder auto-adjust velocity of all axes
?encvel y           Read encoder auto-adjust velocity of Y-axis only
```

21.7. **encrefvel (Encoder Ref.-Signal Calibration Velocity)**

Syntax: `!encrefvel` or `?encrefvel`
Parameter: `x, y, z, a` or none
`0.000001 to 3000` [rev/s] (or [mm/s] if dim = 9 or 10)

Description: Replaces the **!calrefspeed** instruction.
Set or read the velocity, at which the reference mark search is performed (during **!cal**, after releasing the limit switch).

Response: Currently used `encrefvel` in [rev/s] or [mm/s] in dim 9+10

Examples:

```
!encrefvel 5 5 5    Set encoder reference mark search velocity of X, Y, Z to 5
!encrefvel z 0.5    Set encoder reference mark search velocity for Z axis to 0.5
?encrefvel         Read ref mark search velocities of all axes
?encrefvel y       Read ref mark search velocity of Y axis only
```

21.8. `enctype` (Encoder Type Configuration)

Syntax: `!enctype` or `?enctype`

Parameter: `x, y, z, a` or `none`
0 to 2 or 6 (depends on hardware)

Remarks: Most TANGO controllers, from Firmware 1.60 or higher, provide and support a Universal Encoder Interface. This interface can be configured by software to support 5Vpp MR, 1Vpp or digital RS422 incremental encoders. In order to provide the new features, the `encttl` instruction was replaced by `enctype` (`encttl` should not be used anymore).

TANGO Desktop HE provides an Absolute Encoder Interface, which extends the functionality of the Universal Encoder Interface by options for BiSS-C or SSI absolute encoders with or without additional analog 1Vpp signal.

Description: The instruction reads or sets the encoder signal type.

0 = MR 5Vpp analog sin/cos interpolation
1 = TTL RS422 A/B digital incremental signal
2 = 1Vpp analog sin/cos interpolation

TANGO Desktop HE extends the options by absolute interfaces:

3 = Absolute BiSS-C
4 = Absolute BiSS-C with 1Vpp sin/cos analog
5 = Absolute SSI
6 = Absolute SSI with 1Vpp sin/cos analog

The read instruction provides two options:
By using an additional parameter "1" with the read instruction, the effectively by hardware applied encoder type is returned. This might happen when e.g the encoder option was not ordered and the TANGO degrades the interface to TTL counting only. When sent without the parameter 1, the instruction returns the selected encoder type.

Remarks: If digital encoders (A/B-TTL, RS422) are used and the interface by mistake is programmed to an analog signal mode, this can cause a sporadic malfunction (encoders become deactivated) due to analog signal monitoring.

Absolute encoders require additional parameters:
The number of bits (`encform`) and resolution (`encres`).
If the absolute encoders provide an additional 1Vpp signal, the `encperiod` must be set, else not required.

Response: 0 to 6 (or -1 = not available, invalid configuration)

Example:

```
!enctype 1 0 2      Set X encoder to A/B-TTL, Y to MR and Z to 1Vpp
!enctype x 1       Set X encoder to A/B-TTL, leave others unchanged
?enctype           => 1 0 2   Read the requested encoder types of all 3 axes
?enctype 1        => 1 1 1   Read the applied encoder types (e.g. TTL only)
?enctype z        => 2       Read the requested encoder type of the Z axis
?enctype z        => 2       Read the applied encoder type of the Z axis
?enctype a        => 0       Read the requested encoder type of the A axis
?enctype a 1     => -1       Read the applied encoder type of the A axis
```

21.9. encctl (Encoder Configured for TTL Signal)

Syntax: !encctl or ?encctl
Parameter: x, y, z, a or none
 0 or 1

Remarks: **Old instruction for old firmware or old TANGO controllers**
(roughly before the year 2012). Else, do not use!
➔ From Firmware 1.60, the **enctype** instruction should be used.

Description: Set the encoder type to A/B-TTL or read, if TTL is set or not.
 0 = Analog sin/cos encoder (1Vpp or MR is defined by hardware)
 1 = Digital quadrature A/B encoder (e.g. RS422)

Response: Currently selected encoder signal type(s)

Example:
!encctl 0 0 1 Set X and Y axis encoders to analog, Z to digital A/B-TTL
!encctl z 1 Set Z encoder type to digital
?encctl Read encoder signal type of all axes
?encctl x Read encoder signal type of X-axis

21.10. encref (Use Encoder Reference Signal)

Syntax: !encref or ?encref

Parameter: x, y, z, a or none
0, 1, 2 or 3

Description: Configure the use of additional referencing with the cal instruction to achieve a higher position origin accuracy. It can be the reference mark of the encoder signal, or a taught-in signal constellation of an analog encoder signal without reference mark, or of the motor current when no encoder is present but a higher accuracy (less jitter) is required for the origin position of the axis.

0 = No reference signal used (default)
1 = Encoder reference signal used for calibration
2 = Encoder signal period used as reference (set by callrn)
3 = Motor step pos used as reference (set by callrn)

EncRef Mode 1:

If set to 1, the 'cal' instruction will, after reaching the lower limit switch, travel to the reference mark and set the axis position to zero. If the limit switch is disabled, CAL will then execute a calibration on the reference mark only (e.g. for revolving axes). From Firmware 1.74, a position offset can be specified by 'posshift' for encref mode 1.

EncRef Mode 2:

In case of analog encoders with signal periods of at least 100µm (e.g. MR-encoders), there is an option to store the sin/cos signal constellation outside the limit switch (done by factory through 'callrn') which greatly improves accuracy and repeatability of the origin without having a reference mark.

EncRef Mode 3:

If no encoders are present, or do not have an analog signal of the requires signal length, encref mode 3 can be used (e.g. 1Vpp signal with only 10 or 20µm encperiod, or TTL).

Modes 2 and 3 require the signal period being greater than the scatter range of the CAL/E0 switch. For Hall switches, the scatter range (uncertainty of cal position) is usually around 10 to 20 µm. Optical switches scatter around 1 µm.

For mode 3 (referencing on motor signal), it calculates as: $\text{pitch}/(\text{motorsteps}/4)$, e.g. $2\text{mm}/(200/4) = 40\mu\text{m}$. Which means that from a pitch of 2mm and greater, Hall switches (scatter $\approx 20\mu\text{m}$) can be compensated in mode 3 via a callrn teach-in.

Remarks: The velocity towards the reference mark is set by **encrefvel**. The calibration only on a reference mark (E0 switch disabled) is taken from vel (or in extmode=1 from calvel) and can be limited by secvel.

Response: 0 ... 3

Example:

!encref 1 1 0 Use encoder reference signal as origin for X and Y-axis
!encref y 1 Use encoder reference signal as origin for Y-axis
?encref Read Encoder reference signal usage of all axes
?encref z Read Encoder reference signal usage of Z-axis (e.g. 1 1 0)

21.11. encnas (Use Encoder NAS Error Signal)

Syntax: !encnas or ?encnas
Parameter: x, y, z, a or none
0 or 1

Description: Before enabling this functionality, please make sure that the connected encoder provides a NAS error signal. If enabled, an encoder NAS error generates an internal '**encerr**' error state. The NAS input is active low.

0 = NAS encoder input state is ignored (default)
1 = NAS encoder input signal is used for error detection

Remarks: The NAS signal state can be read by '**encnasstatus**'.

Response: Encoder NAS signal used / not used for error detection

Example:
!encnas 1 1 0 Use encoder NAS signal for X and Y-axis, ignore for Z
!encnas x 1 Use encoder NAS signal for Y-axis
?encnas Read encoder NAS signal use state of all axes
?encnas x Read encoder NAS signal use state of X-axis

21.12. encrefstatus (Encoder REF Signal State)

Syntax: ?encrefstatus or encrefstatus
Parameter: x, y, z, a or none

Description: Returns the REF signal input state.

0 = REF signal is inactive
1 = REF signal is active (encoder is on a reference mark)

Response: Encoder reference signal state

Example:
encrefstatus Read REF signal state of all axes
encrefstatus x Read REF signal state of X-axis only

21.13. encrefstatusl (Latched Encoder REF Signal State)

Syntax: ?encrefstatusl or encrefstatusl
Parameter: x, y, z, a or none

Description: Returns the latched REF signal input state. If the REF signal was active since last reading of encrefstatusl, a 1 is returned. The corresponding latch state(s) are cleared after reading.

0 = REF signal is and was inactive since last read
1 = REF signal is/was active (encoder is or was on a reference mark)

Response: Latched encoder reference signal state

Example:
encrefstatusl Read+clear latched REF signal state of all axes
encrefstatusl x Read+clear latched REF signal state of X-axis only

21.14. encnasstatus (Encoder NAS Error Signal State)

Syntax: ?encnasstatus or encnasstatus

Parameter: x, y, z, a or none

Description: Returns the NAS error signal input state. (This signal is usually ignored, but can be enabled by **encnas** as error source)

0 = NAS signal is inactive (High=the encoder reports no error)

1 = NAS signal is active (Low =the encoder reports an error)

Response: Encoder NAS error signal state (=inverted NAS input pin level)

Example:

encnasstatus Read NAS signal (error) state of all axes

encnasstatus x Read NAS signal (error) state of X-axis only

21.15. encerr (Encoder Error State)

Syntax: !encerr or ?encerr

Parameter: x, y, z, a or none

0

Description: This instruction reads or resets the encoder error state. On error, e.g. a low **encamp** signal amplitude or active NAS error signal from the encoder '**encnas**'+'**encnasstatus**', the encoder signal is invalid and the closed loop for the corresponding axis is switched off.

0 = No error, normal function

e = Encoder error

Response: Encoder error state, 0 or e

Example:

!encerr 0 Reset encoder error

?encerr Read encoder error states of all axes, e.g. "0 0 e" for 3 axes

?encerr x Read encoder error state of X-axis only

21.16. encamp (Encoder Signal Amplitude)

Syntax: ?encamp or encamp
Parameter: x, y, z, a or none
 Optional parameter 1

Description: Read the encoder signal amplitude in percent.
 100 represents the maximum undistorted signal
 amplitude.

By default, the encoder amplitude is read as integer value in 1 percent steps.
A higher resolution (1 fractional digit) can be achieved when requesting encamp with the optional parameter 1.

Remarks: For 1Vpp encoders, 100% corresponds to 1.2Vpp, and the typical amplitude is about 80% (1Vpp).

MR encoders require a calibration. This is done automatically by the TANGO when the encoder is activated (either after power-up or after cal, depending on calmode).
Before calibration, the uncalibrated amplitude should not exceed 90% to ensure calibration success. After calibration, the amplitude is based on the individual encoder where 100% means the encoders individual maximum amplitude without distortion. This calibrated amplitude of the activated encoder can appear up to 10% higher compared to the uncalibrated amplitude.
During assembly of an MR encoder, the amplitude should be adjusted to not more than 80%, in order to leave room for variations throughout the life span of the axis such as load conditions, long term effects, etc.

Differential TTL encoders return about 140%.
Single ended TTL encoders, due to the necessary input circuit modifications, might return around 0%.

In case of absolute encoders without an additional 1Vpp signal, the amplitude is fixed and reflects the error and warning state of the data:
No error, no warning = 67 [%] (the desired state)
Warning = 40 [%] (still working)
Error and warning = 0 [%] (error)

Response: Encoder signal amplitude in percent
 as integer or with 1 fractional digit

Example:
?encamp Read all encoder signal amplitudes (returns e.g. 57 74 0)
?encamp x Read X encoder signal amplitude
?encamp 1 Read all amplitudes with 1 fractional digit (57.3 73.8 0.5)
?encamp x 1 Read X encoder signal amplitude with 1 fractional digit (57.3)

21.17. encpos (Encoder Position)

Syntax: !encpos or ?encpos
Parameter: x, y, z, a or none
0 or 1

Description: The position "source" for the **?pos** instruction.
Only affects the readout position values of pos and snsA.
If encpos is set to 1 and the encoder '**enc**' is activated,
pos returns the encoder position, else the motor position.

Remarks: One sets all: for compatibility, sending a single 0 or 1
without specifying an axis applies the setting to all axes.

enc is activated by the TANGO through 'cal' or the calmodes,
not by the user.

The setting of encpos is volatile, but from Firmware 1.72,
a power-on preset setting can be stored by '**configencpos**'.

Response: Position source
0 = pos instruction returns motor position (default)
1 = pos instruction returns encoder position (if enc. Active)

Example:
!encpos 1 a 'pos' instruction will return the encoder position
for all axes (if the axes encoders are active)
!encpos 0 0 1 encoder position is enabled for Z and disabled for X and Y
!encpos x 1 'pos' will return the encoder position for the X-axis
?encpos Use of ?encpos is not recommended. Just for compatibility,
this instruction reads the "ored" position source of all axes
(it returns just one 0 or 1, it returns a 1 if at least one
axis has encpos enabled)
?encpos x Read position source of the X-axis
!encpos 0 1 0 Set individual axes
→ ?encpos -1 => 0 1 0
→ ?encpos => 1 Compatible readout (?encpos only for backw. Compatib.)
→ ?encpos z => 0

!encpos 1 One sets all
→ ?encpos -1 => 1 1 1

Sequence example of a 3 axis TANGO:

```
?calmode => 0 0 0
!encpos 1 1 0 (pos should return the encoder position in X and Y)
?enc => 0 0 0
?pos => [motor pos] [motor pos] [motor pos]
!cal x => @@@-.
?enc => 1 0 0
?pos => [encoder pos] [motor pos] [motor pos]
!cal y => @@@-.
?enc => 1 1 0
?pos => [encoder pos] [encoder pos] [motor pos]
```

21.18. configencpos (Configure Encoder Position Preset)

Syntax: !configencpos or ?configencpos

Parameter: x, y, z, a or none
0 or 1

Description: Set or read the predefined power-up setting for **encpos**. The TANGO will use it as preset value for **encpos** after power-up or reset.

Remarks: As the **encpos** setting is volatile and commonly used, e.g. by SwitchBoard, it should not be storable. In cases where encpos must be activated at power-up, e.g. standalone applications without a PC, configencpos can be used. The function is available from Firmware 1.72.

Setting "!configencpos" also sets the current encpos.

Response: Position source
0 = pos instruction returns motor position (default)
1 = pos instruction returns encoder position (if enc. Active)

Example:

```
!configencpos 0 0 1    Set power-up preset for encpos to X,Y=motor, Z=encoder
!configencpos 1        Set power-up preset for encpos to X=encoder
!configencpos z 0      Set power-up preset for encpos to Z=motor
?encpos                Read the encpos preset values of all axes
?encpos y              Read the encpos preset values of the y axis
```

Sequence example of a 3 axis TANGO:

```
?encpos -1            => 0 0 0    after power-on, the encpos is 0
!configencpos 0 0 1    configuring the !configencpos...
?configencpos         => 0 0 1
?encpos -1            => 0 0 1    ...also changes the encpos...
!save                 => OK...    ...and if saved...
!reset
?encpos -1            => 0 0 1    ...works as a preset for encpos.
```

21.19. encsync (Analog Encoder Synchronization Status)

Syntax: ?encsync or encsync
Parameter: x, y, z, a or none
 -1 or none

Description: Returns the synchronization state of the encoder signal and the digital hardware counter.
Called without parameter, it returns if the encoder(s) are synchronized. When called with "-1", the quadrants of the analog and digital signal paths are shown and the applied correction (deviation) of the digital quadrant.
The deviation should never exceed ± 1 . This instruction is available from TANGO PCI-E/DT-E firmware 1.71 and above.

Response: none: Encoder synchronized = 1, not synchronized = 0
 -1 : encoder signal analog, digital quadrants and deviation.
 Quadrants are 0,1,2,3, the deviation is 0 or +1.
 Please refer to the examples below.

Example:
encsync x → 1 (1 = X encoder synchronized, 0 = not synchronized)
encsync → 1 1 0 (3 axis TANGO, X and Y are synchronized, Z not)
encsync x -1 → 2 3 -1 (X encoder an.quad=2, dig.quad=3,quad.comp.d->a=-1)
encsync -1 → 2 3 -1 2 2 0 0 0 0 (response from a 3 axis TANGO X,Y,Z)

21.20. hwcount (Hardware Counter)

Syntax: ?hwcount or hwcount
Parameter: x, y, z, a or none

Description: Returns the positions of the independent quadrature encoder counter. It counts the signal edges without interpolation, one signal period corresponds to a counter increment of 4. The counting direction depends on the internal '**encdir**'.

Remarks: Refer to '**clearhwcount**' for setting the counter(s) to zero.

Response: Encoder hardware position-counter

Example:
hwcount Returns the position counter of all axes
hwcount x Returns the position counter of X-axis only

21.21. clearhwcount (Clear Hardware Counter)

Syntax: !clearhwcount or clearhwcount
Parameter: x, y, z, a or none

Description: Set the encoder quadrature hardware-counter positions to zero.
Remarks: Only affects the position returned by ?**hwcount**.

Response: none.

Example:
clearhwcount Reset hwcount position of all axes to zero
clearhwcount x Reset hwcount position of X-axis to zero

22. MR Encoder Instructions

22.1. mra (MR Amplitude Correction Factor)

Syntax: !mra or ?mra
Parameter: x, y, z, a or none
0.8 to 1.2

Description: This instruction reads or sets the cosine amplification correction factor of the analogue encoder signal (here: sin/cos amplitude ratio). This factor is calculated automatically on each calibration move '**cal**' and should not be changed. If the axis is manually controlled and only used for relative measurement, so that no '**cal**' is possible, the user may determine the ratio itself and then write it into mra for more accurate results. Please also refer to the '**mro**' instruction.

Response: Currently used correction factor(s)

Example:
?mra Read MR signal correction factor of all axes
?mra x Read MR signal correction factor of X-axis only
!mra x 1.0095 Amplify the X cosine signal by *1.0095 compared to the sine

22.2. mro (MR Offset Correction Value)

Syntax: !mro or ?mro
Parameter: x, y, z, a or none
-2048 to +2048

Description: This instruction reads or sets the sine and/or cosine offset compensation value as 16bit signed digits. This factor is calculated automatically on each calibration move '**cal**' and should not be changed. If the axis is manually controlled and only used for relative measurement, so that no '**cal**' is possible, the user may determine the offset itself and then write it into mro for more accurate results. Please also refer to the '**mra**' instruction.

Response: Currently used correction values

Example:
?mro Read MR signal offset value sine and cosine for all axes
?mro x Read MR signal offset value sine and cosine for X-axis only
!mro 48 -100 0 0 0 0 0 Set X offset to sin=48digit, cos=-100digit, Y, Z = 0
!mro y 16 -28 Set Y offset to sin=16digit, cos=-28digit
!mro y 16 Set only sine offset of Y encoder

22.3. mrp (MR Signal Peak-To-Peak Measuring Result)

Syntax: !mrp or ?mrp
Parameter: x, y, z, a or none
-2048 to +2048

Availability: Older firmware versions only, until TANGO firmware \leq 1.68.

Description: This instruction reads or sets the sine and/or cosine peak values, measured since they were reset the last time. It is just a measurement and has no effect to the signal processing itself. The returned values are signed 16bit digits.

Response: [sine max] [sine min] [cosine max] [cosine min] result(s)

Example:

```
?mrp x Returns [x_sin max] [x_sin min] [x_cos max] [x_cos min]
?mrp Returns the above, but for all axes (up to 16 values)
!mrp x 0 0 0 0 Reset the peak-to-peak measurement for x
!mrp x 0 0 Reset only the X sine min, max values
!mrp 0 0 0 0 0 0 0 0 0 0 0 0 0 0 0 0 Reset measurement for all 4 axes
```

22.4. mrt (MR Signal Level)

Syntax: ?mrt
Parameter: x, y, z, a or none
1 to 32767 and -1 to -32767

Description: This instruction reads the corrected sine and cosine A/D converter results of the analog encoder interface as signed 16 bit integer.

In case of MR encoders, specifying a negative number returns the corrected analog value (offset, amplitude).

The number of data samples (lines) to read should be specified, e.g. "?mrt 1" for returning one sample. If there is no number specified, the instruction returns 10 sampling results per default.

Response: [sine] [cosine] results as signed 16 bit values
or [x_s] [x_c] [y_s] [y_c] [z_s] [z_c] for all
Each data line is terminated by a [CR].

Example:

```
?mrt Returns 10 lines with all axes (up to 6 values per line)
?mrt 1 Returns one line with all axes (up to 6 values)

?mrt x Returns 10 lines with [x_sin] [x_cos] signal digits
?mrt x 1 Returns one line with [x_sin] [x_cos] signal digits
?mrt y 2 Returns two lines with [y_sin] [y_cos] signal digits
?mrt y 1000 Returns 1000 lines with [y_sin] [y_cos] signal digits

?mrt -1 Returns one line, all axes with MR correction applied
?mrt x -10 Returns 10 lines, X axis with MR correction applied
```

23. Absolute Encoder Instructions

2nd gen. TANGOs support Renishaw® Resolute™ BiSS-C and Numerik Jena LAK SSI absolute encoders. **Enc**type, **encres** and **encform** must be specified. If the encoder provides an additional 1Vpp signal (the LAK), **encperiod** must also be specified. A **posshift** parameter is required to align the absolute position to the axis position, as a shift value to the zero position. (This posshift is also used for axes with a Center Reference Mark, therefore see **caldir** modes.) The posshift value can be determined by reading **abspos** at the axis origin or, if an E0/CAL switch is available, after executing **cal** by reading **calabspos**. In order to operate without limit switches, the axis length must be specified. For proper operation, absolute encoders require **calmode** 2.

23.1. encform (Absolute Encoder Data Format)

Syntax: !encform or ?encform
Parameter: x, y, z, a or none
18 to 32 [bit]

Availability: With 2nd generation TANGOs that support absolute encoders.

Description: Length of the position data word in bits. Only the position counting data bit size, excluding error, warn and CRC bits.

Response: Absolute encoder position data word size in bit

Example:

```
!encform 32 32 32      Set the word size to 32 bit for X, Y and Z
!encform z 24         Set the word size to 24 bit in Z
?encform              => 32 32 24   Read the word size of all axes
?encform x           => 32         Read the word size of the X-axis
```

23.2. encres (Absolute Encoder Data Resolution)

Syntax: !encres or ?encres
Parameter: x, y, z, a or none
1 to 10000 [nm]

Availability: With 2nd generation TANGOs that support absolute encoders.

Description: Position data resolution of the absolute encoder interface. In nanometers per counting step (1 bit). Similar to what the encoder period is to analog signals, encres translates the counter value into a position.

Optional read-resolution: When reading, the number of requested fractional digits can be sent. Default = 3.

Response: Absolute encoder resolution in nm (nm per count) with 3 or requested amount of fractional digits

Example:

```
!encres 1 1 78.125    Set resolutions X,Y=1nm, Z=78.125nm
!encres z 78.125     Set resolutions to 78.125nm in Z
?encres              => 1.000 1.000 78.125 Read the resolutions of all axes
?encres z            => 78.125         Read the resolution of the Z-axis
?encres 6            => 1.000000 1.000000 78.125000 Read all with 6 decimal places
!encres 1.2345       Read with default 3 decimal places
?encres x            => 1.235
?encres x 6          => 1.234500      Read with 6 decimal places
```

23.3. abspos (Absolute Encoder RAW Position)

Syntax: ?abspos or abspos
 Parameter: x, y, z, a or none

Availability: With 2nd generation TANGOs that support absolute encoders.

Description: Returns the absolute encoder position at the current position.
 The unit is always [mm].

Optional read-resolution: The amount of fractional digits for the returned abspos value reply can be specified (0 to 16).

Remarks: If the axis provides no lower limit switch (E0/CAL), the instruction can be used to once determine the posshift value for zero alignment (posshift = -abspos).

If no E0/CAL switch is available, the absolute position can be determined by manually shifting the axis to the lowest position (maintain some 1/10mm gap to the mechanical limit) and read the local '?abspos' there.

Response: RAW position of the absolute encoder at the current position.
 The unit depends on dim.

Examples: (at mm dim 2 or 9)
 abspos y => 456.2099
 abspos y 6 => 456.209874
 abspos => 9.7055 456.2099 0.0000 0.0000
 abspos 6 => 9.705519 456.209874 0.000000 0.000000

23.4. Absolute Encoder Settings (examples)

Model	Renishaw® Resolute™ BiSS-C	Numerik Jena LAK
enctype	3 (BiSS Absolute)	6 (SSI Absolute + 1Vpp)
encform	32 (Bit AbsPos Data)	24 (Bit AbsPos Data)
encres	1 (1nm AbsPos Resolution)	78.125 (nm AbsPos Resolution)
encperiod	don't care	0.02 (20µm 1Vpp period)
calmode	2 (Instant On)	2 (Instant On)

24. Closed Loop Instructions

The closed loop control pulls the axis towards the measuring system position, compensating the inaccuracies of the drive.

The closed loop mode is set by the **ctr** instruction. It also requires setting **encmask** for the individual axes (encmask requests enabling of the encoders, which is a precondition for enabling closed loop). Closed loop is finally activated by either executing a calibration (**cal**) or after power-up by selecting the power-up modes (**calmode** 2, 1 or 4).

The **ctrstatus** instructions may be used to check if the closed loop is activated.

Remarks:

Activating closed loop fails if the **pitch**, **gear** or **encperiod** settings are incorrect. The error tolerance of these parameters is about a factor of 2.

The closed loop target window (**twi**, in combination with **ctrd**, **ctrtrt**) is the condition to identify if the axis has reached its target position. In the default closed loop mode (**ctr** = 2) the axis will (continue to) travel precisely to the target position, even if the target window is already reached.

When the optional motor current **reduction** is set below 0.3 (30%), closed loop will be disabled during reduction (axis has stopped and **curdelay** has expired).

The closed loop behavior can be set to different behaviors for reliability or safety, when exceeding a specified deviation. The instructions **ctrsm** and **ctrs** may be used.

24.1. Setting Up the Closed Loop

The closed loop circuit provides several instructions to adjust, optimize and customize its behavior:

- **ctr** - the closed loop mode
- **ctrff** - the closed loop amplification multipliers
- **twi** - the "position reached" deviation criteria
- **ctrd** - the "position reached" time criteria
- **ctrtrt** - the maximum waiting time for the criteria (timeout)
- **ctrsm** - the behavior at greater deviation
- **ctrs** - the definition of greater deviation

Positioning with Closed Loop - twi and ctrd

In closed loop mode the position reached reply is delayed until the specified criteria are fulfilled. The criteria consist of a deviation limit and a time, during which the deviation limit must be kept.

The **twi** and **ctrd** instructions define a window with the height of $\pm twi$ and the width of **ctrd**. If the deviation exceeds $\pm twi$, the delay time begins again. So the $(\pm twi * ctrd)$ window travels along, until the criteria are fulfilled or until the timeout (**ctrtrt**) is reached. In such case the position reached reply will be sent even without fulfilling the criteria.

The window definition is required, as position deviation of the axis isn't just constantly decreasing, there is also oscillation of the axis position:

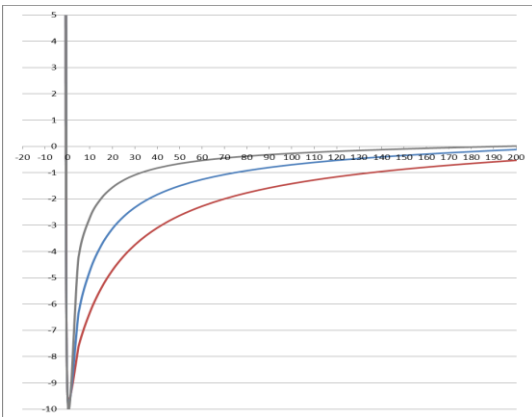

P1 Deviation at the end of a move compensated by the closed loop

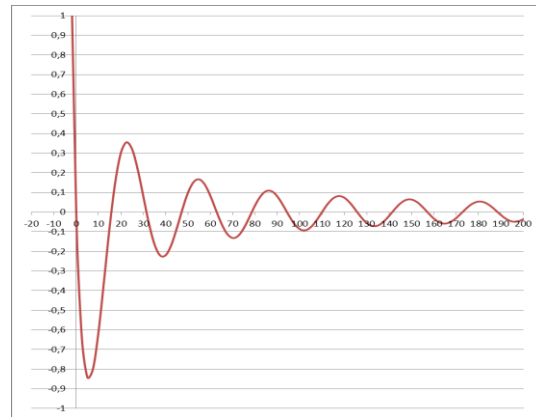

P2 Oscillation at the end of a move (sinusoidal decay)

So without defining a **ctrd** delay time criterion, the position reached reply would be sent as soon as the deviation once went below the **twi** value. But as **P2** shows, this might be just temporary and the deviation will build up again (oscillation). To be safe, **ctrd** time must be at least the oscillation period, which makes sure both, minima and maxima of the deviation are checked within the criteria window **.

Example: **twi** is $\pm 0.2\mu m$ and **ctrd** is 30ms. In **P2**, the **twi** limit is exceeded at 1ms and remains exceeded until about 14ms. During this time, the **ctrd** time countdown of 30ms is constantly restarted. At 18ms the **twi** limit is exceeded once again until about 29ms, during this time the **ctrd** time is restarted again. After 29ms, the deviation remains within $\pm twi$. So **ctrd** keeps counting down its 30ms and replies the position reached event $29+30 = 59ms$ after the original move has completed.

** If the oscillation decays as in the picture P2 (steadily and centered around the zero deviation), a `ctrd` time of half the oscillation period would be sufficient. This is because each half wave is smaller than the one before. But most likely the deviation will behave like a combination of P1 and P3, where the oscillation decays, but it oscillates around the deviation. In such case and as a general recommendation, the `ctrd` value should be set to at least the oscillation period. If it is known that other mechanical parts except the axis do oscillate after a move, those times could be included in the `ctrd` wait time as well.

Closed Loop Setup

The closed loop factor `ctrff` can be used in order to reach the `twi` and `ctrd` criteria more quickly.

In general, its default values of 2 and 2 provide a good base to start from. `Ctrff` has two parameters per axis. The first one is the factor applied when the axis is traveling, the second is applied when the axis stopped traveling and is idle. Picture P1 shows how increasing the second factor influences compensation of position error at the end of a move. Greater values cause the axis to compensate faster, but from a certain point might begin to be unstable.

Closed Loop behavior

`Ctr` sets the general behavior of the closed loop, which might be off, always on or on until position is reached.

In addition, a behavior can be set when the position deviation exceeds a certain limit. Please refer to the `ctrsm` and `ctrs` instructions.

Examples

1: enable closed loop for X and Y axes only

```
!ctr 2 2 0
!encmask 1 1 0
!cal
```

2: enable closed loop individually for Z axis

```
!ctr z 2
!encmask z 1
!cal z
```

3: enable closed loop for X and Y from power-on

```
!ctr 2 2
!encmask 1 1
!calmode 2 2
save
(then cycle power or send reset instruction)
```

24.2. ctr (Control Enable)

Syntax: !ctr or ?ctr
Parameter: x, y, z, a or none
0,1,2 (,3,4)

Description: Set or read the closed loop mode.

0 = Closed Loop OFF
1 = Closed Loop until target (inactive when position reached)
2 = Closed Loop always active (default, recommended)
3 = (not supported, behaves like mode 1)
4 = (not supported, behaves like mode 2)

Closed loop mode is activated by either executing **cal** or after a power up or reset (refer to **calmode**).

If encoders were activated at power on (**encmask** = 1), closed loop can be switched on (0->1, 0->2) afterwards. Closed loop mode can also be changed during operation.

Preconditions for successfully entering closed loop are having **ctr** and **encmask** set.

Pros and Cons: Mode 1: (+) Axis is stopped after reaching the target window
(-) Position is scattered within $\pm twi$ range
(-) Position deviation may occur due to external influence (drive concept, gravity, etc.)
(-) Is only active when moving
(-) Causes deviation when used with current **reduction**
(-) Can cause a position jump at the beginning of a move, if a deviation exists (see influences above)

Mode 2: (+) Always stays closest possible to target position
(+) Compensates external influences and forces
(-) Might still travel after position is reached (after the "@@@" reply of the target window) as it always travels towards zero deviation
(-) Might not absolutely stand still after reaching a position. Depending on drive concept, slip stick effects can cause the axis to slightly bounce between positions within e.g. ± 50 nanometers. similar might happen with TTL encoders of coarse resolution. Then mode 1 might be preferred.

Remarks: Using closed loop mode 2 is recommended for most applications.

Mode 1 is recommended only if the application does not stand still sufficiently in the end position (e.g. long exposures). In this case, the HDI - especially an ERGODRIVE - should be disabled, too (by e.g. **!joydir** 0 0 0 0 or **!joy** 0 instruction).

Response: Closed loop mode(s)

Examples:

!ctr 0 0 0 0 Closed loop off for all axes (here: 4 axes)
!ctr 2 2 Closed loop for X- and Y-axis permanently on
!ctr z 1 Closed loop for Z-axis switches off after position reached
?ctr Read closed loop states of all axes
?ctr x Read closed loop state of X axis

24.3. ctrf (Control Factor)

Syntax: !ctrf or ?ctrf
Parameter: x, y, z, a or none
0 to 25.0

Description: CTRF IS **FOR COMPATIBILITY ONLY - PLEASE USE CTRFF!**
This instruction reads or sets the closed loop factors.
Higher values result in more stiffness and faster settling.
Above a critical value this may lead to oscillation.
The default factor of 2.0 mostly results in a good behavior.
Hint: Using the ctrff instruction instead offers more options.

Remarks: Even if setting the parameter supports floating point, the return value is integer (for compatibility).
When using ctrf, the one parameter applies to both, idle and move. It is recommended to use ctrff instead of ctrf.

Response: Closed loop factors as integers (rounded)

Examples:
!ctrf 2 2 2 Set closed loop factor to 2 for all axes
!ctrf z 3.5 Set closed loop factor for Z axis to 3.5
?ctrf Read closed loop factors of all axes (as integer)
?ctrf z => 4 Read closed loop factor of Z axis (as integer, 3.5 → 4)

24.4. ctrff (Extended Control Factor)

Syntax: !ctrff or ?ctrff
Parameter: x, y, z or a
0.0 to 25.0
0.0 to 25.0

Description: This instruction reads or sets 2 closed loop factors per axis.
Higher values result in more stiffness and faster settling.
Above a critical value this may lead to oscillation.
The default factor of 2.0 mostly results in a good behavior.
Important: Can only be set per axis (with x,y,z,a specified)

Parameter1: Is used while axis is traveling
Parameter2: Is used when axis is idle or while trying to settle within the target window (**twi**)

Parameter 2 can be set to higher values than Parameter1 to achieve smoother axis travel while still having the stiffness and faster settling times at the end of a move.
(E.g.: "!ctrff x 2 4".)

Response: Closed loop factors (2 per axis) as fractional numbers

Examples:
~~!ctrff 2 2 2 2~~ Not supported!
!ctrff x 2 4.5 Set closed loop factors for X axis 2(moving) and 4.5(reached)
!ctrff x 0 0 Disable closed loop in X, while loop calculations keep running
?ctrff Read closed loop factors of all axes (2 parameters per axis)
?ctrff y Read closed loop factors of Y axis only (2 parameters)
?ctrff => 2.0 4.5 2.0 2.0 2.0 (response of a 3 axis TANGO)
?ctrff y => 2.0 2.0

24.5. ctrd (Control Target Window Delay)

Syntax: !ctrd or ?ctrd
Parameter: 0 to 1000 [ms]
optional axis x,y,z,a

Description: This instruction reads or sets the target window delay that is used as a position reached criteria in closed loop mode. The position deviation at the end of a move must remain inside the target window (**twi**) for this amount of time, then the "position reached" state is set. If the target window is left before the delay time is over, the delay starts counting again. Please also refer to the **ctrt** timeout, which aborts the waiting for **twi+ctrd** after a certain amount of time. Either one delay for all axes can be set or axes can be set individually.

Remarks: Setting the delay time to zero forces the axis to immediately reply without waiting for the axis to match the target window.

In all other cases, **ctrd** delay times must be set higher than the **ctrc** interval (>5ms).

While the default target delay of 100ms works with most drive concepts, it may be optimized for performance individually. In order to find the optimal setting, the sinusoidal decay of the axis must be measured. To be safe, the **ctrd** delay time should be at the signal period of the mechanical oscillation.

Response: Closed loop control delay in milliseconds.

Examples:
~~!ctrd 50 50 50~~ Not supported!
!ctrd 50 Closed loop target window delay to 50 ms for ALL AXES
!ctrd x 25 Closed loop target window delay to 25 ms for X axis
?ctrd Read closed loop target window delay (for backw.compatibility)
?ctrd y Read closed loop target window delay of Y axis
?ctrd -1 Read closed loop target window delay of all axes

24.6. ctrt (Control Timeout)

Syntax: !ctrt or ?ctrt
Parameter: 0 to 10000 [ms]

Description: This instruction reads or sets the control timeout. It specifies the maximum time the closed loop tries to reach the desired **target window**. If the **ctrd+twi** condition could not be fulfilled within this **ctrt** time, it will be aborted. The **ctrt** timeout should be set to a value higher than **ctrd**, usually to the default of 1 second. The unit is milliseconds. Only one parameter for all axes.

Remarks: Setting the timeout to zero forces all axes to immediately reply without waiting to match their target windows.

Response: Closed loop control timeout in milliseconds.

Examples:
!ctrt 1000 Closed loop tries to reach the target window for 1 second
?ctrt Read closed loop timeout

24.7. twi (Target Window)

Syntax: !twi or ?twi
Parameter: x, y, z, a or none
±window size, unit depends on **dim**, range = 0.00001 to 1 mm

Description: This instruction reads or sets the closed loop control target window width (+-). While increasing this value leads to position variance, setting a too narrow window may result in closed loop timeouts (higher ctrd, ctrt values required). The unit depends on **dim**.

From Firmware 1.73 when reading, an optional read-resolution of 0 to 6 (1mm to 1nm) can be specified. Without specifying, the resolution depends on the setting of '**resolution**'.

Remarks: The target windows minimum size should not be set smaller than the encoder resolution and noise. Please make sure the measuring system is able to deliver the required signal quality. For analog encoders the limit might be between 1/1000 to 1/5000 of the signal period, which in case of MR encoders about 0.5µm and for a 4µm optical scale 4nm. In case of RS422 A/B-TTL encoders, the window must be at least as large as the minimum count step (1/4 encperiod). If the target window is smaller than the '**resolution**', e.g. 50nm, either the resolution must be increased or the twi must be read with higher resolution by specifying it.

Response: Closed loop target window. The unit depends on **dim**.

Examples:

```
!twi 0.001 0.001 Closed loop target window ±1.0µm (if dim=2) for X and Y-axis
!twi y 0.002 Closed loop target window ±0.2µm (if dim=2) for Y-axis
?twi Read target window of all axes
?twi z Read target window of Z-axis
?twi 6 Read target window of all axes with 1nm resolution
?twi z 6 Read target window of Z-axis with 1nm resolution
!twi z 0.00005 Example: Set twi in Z to 50nm (here at "mm" dim 2 or 9)
?twi z => 0.0000 Then reading will return 0 at the default resolution (4)
?twi z 6 => 0.000050 Firmware 1.73 and higher provide individual resolution
```

24.8. ctrc (Control Call)

Syntax: !ctrc or ?ctrc
Parameter: 1 to 100 [ms] **DO NOT CHANGE!**

Description: This instruction reads or sets the controller call interval. It specifies the time interval in which the closed loop circuit checks the position deviation.

The unit is milliseconds. There is only one parameter which applies to all axes. **THE DEFAULT FACTORY SETTING (3 or 5 ms) depends on the TANGO controller and SHOULD NOT BE CHANGED.** Values of less than 3 [ms] are not recommended.

Response: Closed loop control call interval in milliseconds.

Examples:

```
!ctrc 5 Closed loop control is executed every 5 milliseconds
?ctrc Read closed loop call interval
```

24.9. ctrsm (Control behavior outside Lock-in Range)

Syntax: !ctrsm or ?ctrsm
Parameter: x, y, z, a or none
0 to 5

Description: Behavior of the closed loop circuit when outside the lock-in range (**ctrs**). When outside the ctrs lock-in range, which is regarded to be an error, the TANGO controller can treat this condition as follows:

0 = Continue as usual, motor might possibly stall (default)
1 = Limit the closed loop velocity (avoid stalling the motor)
2 = Disable closed loop until returning to lock-in range
3 = Disable closed loop permanently
4 = Axis is set to latched stop condition (read remarks)**
5 = Switch off all power stages (like sending "!pa 0")

Remarks: ** **stoppol** is manipulated by this function in order to achieve a latched stop (stoppol value is or'ed by 4).
The stop condition must be released by sending "**!stop 0**"

ctrsm 1 assures to return from large deviations without stalling the motor. If outside the **ctrs** lock-in range, a slow return velocity is applied. In most cases it is the better, reliable alternate to the default ctrsm 0.

Ctrsm modes 3 to 5 may be used for safety.

Response: Selected Behavior of the axes (as integer value)

Examples:
!ctrsm z 1 Select slow mode in Z (to avoid stalling of the motor)
!ctrsm 5 5 5 Select switch off mode for safety (e.g. collision detection)
?ctrsm Read all behaviors
?ctrsm y Read behavior of Y-axis only

24.10. ctrs (Control Lock-in Range)

Syntax: !ctrs or ?ctrs
Parameter: x, y, z, a or none
0.001 [mm] to [**maxpos**]

Description: Lock-in range of the closed loop circuit.
When the closed loop position difference exceeds this limit, the behavior defined with **ctrsm** is applied to the axis/axes. The unit depends on **dim**.

Remarks: From Firmware 1.73 when reading, an optional read resolution of 0 to 6 (1mm to 1nm) can be specified. Without specifying, the resolution depends on the setting of '**resolution**'.

Response: Closed loop lock-in range(s), unit depends on **dim**.

Examples:
!ctrs 0.5 0.5 0.2 Set lock-in range of X=0.5mm, Y=0.5mm, Z=0.2mm (if dim=2 or 9)
!ctrs z 0.1 Set lock-in range of Z=0.1mm (if dim = 2 or 9)
?ctrs Read lock-in range of all axes
?ctrs z Read lock-in range of Z-axis only

24.11. ctrstatus (Control Status)

Syntax: ?ctrstatus or ctrstatus

Parameter: x, y, z, a or none
0, 1, 2, 3 or none

Description: Read the internal closed loop states of the specified or all axes. Options and responses are:

A) Called without parameter:

Returns the internally applied **ctr** state which is set when the closed loop gets enabled by the controller (after !cal or when in calmode=1 or 2).

0 = Closed loop permanently off (or not activated yet)
1 = Closed loop only active while axis is traveling
2 = Closed loop always on (the default closed loop mode)
(3 = Closed loop only active while axis is traveling)
(4 = Closed loop always on)

B) Called with parameter "1":

Check if the closed loop is currently active.

0 = Closed loop not active
(e.g. ctr=0, ctr=1, !cal running, encerr, limit swich)
1 = Closed loop active

C) Called with parameter "2":

Check if closed loop is in target window.

0 = Position outside target window
1 = Position in target window

D) Called with parameter "3":

Check if closed loop is in lock-in range.

0 = Position outside lock-in range
1 = Position in lock-in range

E) Called with parameter "0": (All in one request)

Returns the internally applied **ctr** state, like **A)** does and a second hex parameter representing all state bits of the calling parameter 1,2,3 like cases **B,C,D** above:

Bit 0 (0x1): Closed Loop Active
Bit 1 (0x2): Closed Loop in Target Window
Bit 2 (0x4): Closed Loop in Lock-In Range

Response: Closed loop state, 1 or 2 decimal numbers. See "Description".

Examples:

?ctrstatus Returns the internally running ctr mode of all axes
?ctrstatus y Returns the internally running ctr mode of the Y-axis

?ctrstatus 1 Returns the Closed Loop active state of all axes, e.g. "1 1 0"
?ctrstatus x 1 Returns the Closed Loop active state of the X-axis, e.g. "1"

?ctrstatus 2 Returns if Closed Loop is in target window, e.g. "1 1 0"
?ctrstatus z 2 Returns if Closed Loop of the Z-axis is in target window

?ctrstatus 3 Returns if Closed Loop is in lock-in range, e.g. "1 1 0"
?ctrstatus z 3 Returns if Closed Loop of the Z-axis is in lock-in range

ctrstatus x 0 → 2 7 (ctr mode 2 is applied, is active/in window/in range)
ctrstatus 0 → 2 7 2 7 0 0 (response of 3 axes X X Y Y Z Z)

24.12. ctrdiff (Control Position Difference)

Syntax: ?ctrdiff or ctrdiff
Parameter: x, y, z, a or none
 None, 1, 2, 3 or 4

Description: This instruction returns the momentary measured closed loop position difference between the motor- and encoder position.

From TANGO Firmware 1.69, ctrdiff can be used without a '?'.
From TANGO Firmware 1.72, when called with an axis x, y, z, a, ctrdiff returns at least 5 fractional digits (10nm resolution) and a second parameter which indicates if the motor is running (=1) or idle (=0).

2nd gen. TANGOs from Firmware 1.79, using a negative parameter causes a leading timestamp in ms since power-on of the TANGO.

The unit of the returned value depends on the **dim** settings. For higher resolutions the **resolution** value can be increased.

Difference is only calculated when closed loop is activated. To measure position deviations without closed loop influence, the closed loop **ctrff** parameters can temporarily be set to 0 in order to suppress regulation.

Remarks: Momentary position difference, refer to examples.

Response: Momentary position difference, refer to examples.

Examples:
?ctrdiff Returns the position difference of all axes
?ctrdiff y Returns the position difference of the Y-axis, e.g. "0.0015"

From Firmware 1.69:

?ctrdiff Returns the position difference of all axes
ctrdiff same as ?ctrdiff, question mark not required
ctrdiff z Returns the position difference of the Z-axis
ctrdiff x 1 Returns the internal closed loop circuit output signal of X
ctrdiff 1 Function not available, behavior is same as ctrdiff

From Firmware 1.71:

ctrdiff same as ?ctrdiff, question mark not required
ctrdiff z Returns the position difference of the Z-axis
ctrdiff x 1 Returns the internal closed loop circuit output signal of X
ctrdiff 1 Returns the internal closed loop output signal of all axes
ctrdiff 2 Returns the internal motor position shift of all axes
ctrdiff x 2 Returns the internal motor position shift of the X axis
ctrdiff y 3 Returns position difference AND output signal of Y
ctrdiff 3 Not supported
ctrdiff y 4 Returns position difference AND motor position shift of Y
ctrdiff 4 Not supported

From Firmware 1.72:

ctrdiff z => -0.13852 0 (5 fractional digits and "motor idle")
ctrdiff z => 0.06331 1 (5 fractional digits and "motor running")
ctrdiff x 1 => 17.88353 1 (5 fractional digits and "motor running")
ctrdiff x 2 => 22.06331 1 (5 fractional digits and "motor running")
ctrdiff x 3 (as with earlier firmware)
ctrdiff y 4 (as with earlier firmware)

25. Trigger Output Functionality (option)

Trigger functionality must be configured by factory.

To identify if the Trigger functionality is configured, use `'?det'` or `'detext'`.

The trigger output generates TTL signals dependent either on axis positions or as a constant frequency. It can be used to synchronize external devices like e.g. a camera. TANGO Desktop, PCI/PCI-E and TANGO 3 mini provide up to 2 trigger outputs via the optional AUX I/O connector. See **mode** and **output description**.

A special trigger mode - ideal for on the fly scanning applications - is provided by the `!trigr` instruction. This mode achieves the highest accuracy. A more sophisticated mode is provided by `!trigp`, an individual position list.

The trigger can be based on the motor position or on the more accurate encoder position, if the axis provides position encoders.

Axis positions and analog inputs can be captured on trigger by **SnapShot Mode 8**.

The LED100 illumination is active low and typically wired to OUT2 (TAKT_OUT). Remarks: If **hdimode** controls the LED100, it can interfere with TAKT_OUT.

The trigger signals are processed in a 40-microsecond interval.

Before enabling the trigger function by `!trig 1`, please ensure that all trigger settings have been made.

```
Example1:  !trig 0[CR]           Disable trigger globally
           !trigm 0[CR]        Select trigger mode 0
           !triga x[CR]        Set X axis as trigger source
           !trigd 0.100[CR]    Set trigger distance to 100µm (if dim = 2)
           !trigs 400[CR]      Set trigger pulse width to 0.4ms
           !trig 1[CR]        Enable trigger and set start position
```

```
Example2:  !trig 0[CR]           Disable trigger globally
           !trigs 120[CR]        Set trigger pulse width to 120µs
           !trigf 2500[CR]      Set pulse frequency to 2.5kHz
           !trigm 100[CR]       Select trigger mode 100 (periodic signal)
           !trig 1[CR]        Enable trigger
```

Optional: `!trigcount 0` instruction may be executed to reset the event counter.

25.1. trig (Trigger)

Syntax: `!trig` or `?trig`
Parameter: 0 or 1

Description: This instruction enables or disables the trigger circuit. The position at which `!trig 1` is executed also defines the start position for trigger modes 0 to 11 (→current pos).

0 = Trigger function globally disabled
1 = Trigger function globally enabled

Response: 0 or 1

Examples:
`!trig 1` Enable trigger circuit (and define the start position = here)
`?trig` Read enable state of trigger circuit

25.2. trigm (Trigger Mode)

Syntax: !trigm or ?trigm
 Parameter: 0 to 11, 100 to 105

Description: This instruction selects the required trigger mode.

Trigger Mode	Trigger Generation	Trigger Signal	Remarks
0		High active	First pulse when move starts <i>Direction forward</i>
1		High active	First pulse when move starts <i>Bidirectional</i>
2		High active	First pulse when move starts <i>Direction backward</i>
3	-- See Mode 0 --	Low active	Same as 0, signal inverted
4	-- See Mode 1 --	Low active	Same as 1, signal inverted
5	-- See Mode 2 --	Low active	Same as 2, signal inverted
6		High active	Triggers shifted by $\text{trigd}/2$ <i>Direction forward</i>
7		High active	Triggers shifted by $\text{trigd}/2$ <i>Bidirectional</i>
8		High active	Triggers shifted by $\text{trigd}/2$ <i>Direction backward</i>
9	-- See Mode 6 --	Low active	Same as 6, signal inverted
10	-- See Mode 7 --	Low active	Same as 7, signal inverted
11	-- See Mode 8 --	Low active	Same as 8, signal inverted
100	Periodic trigger signals the frequency can be set by "trigf" instruction	High active	Does not depend on position
101		Low active	
102	Manually forced trigger signals by the "trigger" instruction which releases one or several pulses	High active	Does not depend on position or time
103		Low active	
104	Position reached trigger signal of the specified "triga" axis, when all moves have completed, see Remarks.	High active	Comes with the "@@@" Response, → 'autostatus' must be on (not 0)
105		Low active	

Remarks:

The start position is defined by the position where the trigger was globally enabled (by "**!trig 1**" instruction).

Trigger modes 20 and 21 are applied internally by the **trigr** and **trigg** instructions. In those two cases trigger mode 20 is for increasing positions (pos. direction), trigger mode 21 is for decreasing positions (neg. direction). The trigger must be activated when the triggered axis is at a position at or below (mode 20) or at or above (mode 21) the first trigger position.

Trigger modes 104 and 105 are meant to generate a trigger signal when the axis specified by **triga** has completed its move.

But the trigger signal will only be generated after all axes have stopped (because the trigger here is coupled with the autostatus "###" reply of the move instructions). This must be considered, if the trigger axis is not the only moving axis in trigger modes 104 and 105. The other axes will not generate a trigger, but the trigger of the specified axis will be delayed until those other axes have stopped their move.

If the move is not executed or did not start (due to e.g. a stop condition or a travel distance of zero), the trigger is not generated.

Response:

Trigger mode as integer: 0 to 11, (20,21), 100 to 105

Examples:

```
!trigm 0      Select trigger mode 0
?trigm       Read current trigger mode (returns e.g. 0)
```

25.3. triga (Trigger Axis)

Syntax: !triga or ?triga
Parameter: x, y, z or a

Description: This instruction selects the axis on which to trigger.

Response: x, y, z or a

Examples:

```
!triga y      Select Y-axis as trigger source
?triga       Read current trigger axis (returns x,y,z or a as lower case)
```

25.4. trigo (Trigger Output)

Syntax: !trigo or ?trigo
Parameter: 0 to 15

Description: This instruction selects the trigger outputs.

The secondary output TAKT_OUT provides extended functionality:
2, 3: 1:1 mode, generating the same signal as output 1
6, 7: precise width
10,11: high precision delay
14,15: precise (and optionally even higher) frequency

TAKT_OUT is also the default output to control the LED100.

Output / Mode	STANDARD	PREC.WIDTH2	PREC.DELAY2	PREC.FREQUENCY2
No output No signal out	0	(4)	(8 PCI-E)	(12)
Primary TRIGGER OUT	1	(5)	(9 PCI-E)	(13)
Secondary ** TAKT OUT	2	6	10 (PCI-E)	14
Both, P&S ** TRIGGER+TAKT	3	7	11 (PCI-E)	15

A combined delay and width of 40µs resolution is available in standard modes 1,2,3 by the **trigs** instruction.

****** For further information on the second trigger output, please refer to **trigs**, **trigwidth**, **trigbdelay**, **trigbf** and the description of the **second trigger signal output**.

Remarks: Options depend on hardware: TANGO PCI-E/DT-E, TANGO 3 mini and 2nd gen. TANGOs with AUX connector offer all features. PCI-S based controllers do not provide the precision delay function (only a precise edge is generated there) and TANGO mini or integrale provide none or one trigger output.

Response: Selected trigger outputs

Examples: !trigo 0 No output signal
!trigo 1 Default trigger output (TRIGGER_OUT)
!trigo 2 Secondary trigger output (AUX I/O TAKT_OUT, LED100)
!trigo 3 Both trigger outputs 1:1 (TRIGGER_OUT and TAKT_OUT)
?trigo Read back the selected trigger output mode

25.5. trigs (Trigger Signal Length)

Syntax: !trigs or ?trigs
Parameter: 0 to 2500000 [μ s], optional -1
or optional 3x 0 to 2500000 with secondary trigger option

Description: This instruction sets the trigger pulse width in the range of 40 microseconds to 2.5 seconds in increments of 40. (0 = shortest trigger signal width, narrow pulse)
If the parameter is not a multiple of 40 it will be rounded to the nearest multiple: e.g. 90 \rightarrow 80, 100 \rightarrow 120.
When read back, the corrected (nearest) value is returned.

Remarks: **Secondary Trigger Option:** TANGO controllers with a secondary trigger output (AUX I/O) offer a **1:1 mode**. When !trigs is called with 3 parameters, OUT2 provides the option of a delay and individual width. Both parameters must be specified and may be set from 0 to 2500000 (μ s) in increments of 40 (μ s), as mentioned above.
From Firmware 1.74, the delay and width of the second output can be read back by "?trigs -1".

The 2nd trigger signal must be active within the range of the 1st signal. At the end of signal 1, signal 2 is set back to inactive, too. For further information, refer to the trigger description of the **Standard 1:1** output mode.

Example: !trigs 120 40 80
Generates 120 μ s on OUT1 and a 40 μ s delayed 80 μ s long pulse on OUT2. The 2nd and 3rd parameter cannot be read back by ?trigs, it only returns the signal length of output OUT1.

Response: 0 to 2500000 (μ s) trigger signal length

Examples:
!trigs 40 Set Trigger pulse width to 40 μ s
!trigs 2500000 Set Trigger pulse width to 2.5 s
?trigs Read current trigger pulse width

!trigs 200 40 80 Set Trigger output 1 pulse width, delay, output 2 pulse width
The two additional parameters cannot be read back with ?trigs
?trigs -1 Read current trigger pulse width and the output 2 delay+width

25.6. trigd (Trigger Distance)

Syntax: !trigd or ?trigd
Parameter: 0.0 to 5000000 (unit depends on **dim** of the selected axis)

Description: This instruction sets or reads the trigger distance.
Equidistant trigger signals are generated in this position interval.

Remarks: The trigger axis (**triga**) should be defined before setting trigd.

Response: Trigger distance (the unit is defined by **dim**)

Examples:
!trigd 3.01 Set trigger distance to 3.01mm (if dim of selected axis is 2)
?trigd Read the trigger distance

25.7. trigcomp (Trigger Compensation)

Syntax: !trigcomp or ?trigcomp

Parameter: -10000 ... +10000 [μ s]

Description: Time delay compensation for position trigger (look ahead). It releases the trigger at an earlier (+) or later (-) time in order to be executed at the required position.

It can be used to compensate time delays in the signal chain or to center a trigger pulse around the target position, as described in Application 1 and 2 below:

Application 1: To avoid stitching mismatch with bidirectional scans (and so increase performance by not requiring unidirectional)

At high velocity on the fly scans, the delay of the trigger signal chain has an effect on where the sample is taken. When scanning in both directions, this effect becomes visible typically by a comb-like appearance of the stitched image **. This can be greatly improved or entirely removed by the trigcomp delay compensation.

Example: If a camera has a shutter release delay of 100 μ s and the axis travels at 10mm/s, an uncompensated bidirectional scan will cause a 1 μ m shift in each direction, causing a 2 μ m shift between forward and backward direction. When this delay is compensated by "!trigcomp 100", the trigger is generated 100 μ s earlier. The correct position is calculated internally in the TANGO controller, based on the trigcomp delay and the momentary velocity the axis travels at the trigger position. This way the camera will take the picture without a position shift.

The compensation also works within acceleration ramps outside the constant travel velocity. But it must be considered that, during acceleration and deceleration, the true velocity of the axis might differ from the internal, theoretical value and also that oscillation may occur. All leading to not as perfect circumstances as during constant velocity.

** Remarks:

The described comb effect can also be caused by a mechanical backlash of the scan axis. On open loop axes without encoder feedback, the effect can possibly be minimized by using the **backlash** compensation.

Application 2: To generate a symmetrical trigger pulse where the trigger position is in the pulses center, meaning it is active for a certain time before and after the trigger position.

Example: The pulse is 200 μ s long and should be active 100 μ s before and after the trigger position

→ **trigs** 200, trigcomp 100 (length 200 μ s, 100 μ s earlier)

Remarks: Before TANGO Firmware 1.77, a newly set trigcomp factor is only applied after re-enabling the trigger by "!trig 1".

Response: Compensated trigger delay in [μ s]

Examples: !trigcomp 130 Compensate a signal chain delay of 130 μ s
?trigcomp Read the compensation delay (e.g. returns 0)

25.8. trigenc (Trigger on Encoder)

Syntax: !trigenc or ?trigenc

Parameter: 0 or 1

Description: Trigger position source select, encoder or motor position.

0 = Trigger position from motor position (default)

1 = Trigger position from encoder (true position)

Remarks: Triggering on encoder position is designed for analogue 1Vpp or MR encoders. When using A/B-TTL encoders, the available position range might be extremely limited due to the short encoder period. The valid trigger position range is ± 32000 encoder periods
Examples:

- MR @ 500 μ m * ± 32000 = ± 16000 mm

- 1Vpp @ 20 μ m * ± 32000 = ± 640 mm

- TTL @ 1 μ m * ± 32000 = ± 32 mm

Remarks: Before firmware 1.79, when using trigenc 1, the encoder must be active (?enc = 1), else the trigger cannot be activated. From firmware 1.79, if trigenc = 1 and enc = 0, the trigger can be activated (trig 1) but then uses the motor position. Workaround for Firmware before 1.79: Ensure trigenc is 0 if no encoder is present, e.g. by checking ?enc before and then setting the trigenc same as the ?enc reply:

```
!triga x
...
?enc x ==> 1
!trigenc 1 (or 0, both possible)
```

```
!triga x
...
?enc x ==> 0
!trigenc 0 (must be 0)
```

Response: Currently selected trigger position source (0 or 1)

Examples:

!trigenc 1 Trigger based on the encoder signal, if available

?trigenc Read the trigger position source, e.g. 0

25.9. trigf (Trigger Frequency)

Syntax: `!trigf` or `?trigf`

Parameter: 0.01 to 25000

Description: This instruction sets the frequency for periodic trigger output modes **trigm** 100 and 101. The internal frequency resolution is in steps of 1/40 μ s.

Response: Trigger frequency

Remarks: As the internal resolution has 40 μ s steps, the resulting frequency might not always match the requested frequency. The higher the frequency, the more deviation may occur (e.g. 2500 exactly meets the frequency, 2600 does not). In order to identify the resulting frequency, `?trigf` can be used.

For highly accurate frequencies with fine resolution, the second trigger output can be used (refer to **trigbf**).

From TANGO Firmware 1.60C / 1.61 it is also possible to send a fixed number of trigger pulses at the specified `trigf` by using the manual trigger modes 102, 103 and calling the manual **!trigger** instruction with the number of pulses as parameter. Refer to **trigger** description.

Examples:

`!trigf 2500` Periodic trigger pulses at 2.5kHz (signal every 0.4ms)
`?trigf` Read trigger signal frequency (the true value)

25.10. trigbdelay (Precise Trigger Delay for second output)

Syntax: !trigbdelay or ?trigbdelay
Parameter: 0.00 to 32500000 [µs]

Description: Precise delay for secondary trigger output signal (TAKT_OUT). Applies to trigger output settings !trigo 10 and 11. Unit in microseconds [µs], resolution is 1/132µs.

Remarks: Secondary trigger can either have precise width or delay. **Available with TANGO PCI-E, Desktop-E and TANGO 3 mini, Desktop HE, TANGO PCIE21. TANGO PCI-S and Desktop-S only provide a delayed signal edge (rising or falling), while the signal state before and after the trigger pulse remains in an active state.**

Response: Delay time in µs

Examples:
!trigbdelay 0.35 Delay the secondary trigger signal by 350ns (to TRIGGER_OUT)
?trigbdelay Read the secondary trigger delay (e.g. returns 0.00)

25.11. trigbwidth (Precise Signal Width for second output)

Syntax: !trigbwidth or ?trigbwidth
Parameter: 0.00 to 32500000 [µs]

Description: Precise width for secondary trigger output signal (TAKT_OUT). Applies to trigger output settings !trigo 6 and 7. Unit in microseconds [µs], resolution is 1/132µs.

Remarks: Secondary trigger can either have precise width or delay. **Only available with TANGO PCI-S, PCI-E, Desktop-S, Desktop-E, TANGO 3 mini, Desktop HE, TANGO PCIE21.**

Response: Signal width in µs

Examples:
!trigbwidth 5.01 Set secondary trigger signal width to 5.01µs
?trigbwidth Read the secondary trigger signal length (e.g. returns 40.00)

25.12. trigbf (Precise Trigger Frequency for second output)

Syntax: !trigbf or ?trigbf
Parameter: 0.010 ... 66000000 [Hz]

Description: Precise frequency for secondary trigger output (TAKT_OUT). Applies to trigger output settings !trigo 14 and 15. Unit is microseconds [µs], resolution is 1/132µs.

Remarks: Trigcount does not count the precise trigger events. **Only available with TANGO PCI-S, PCI-E, Desktop-S, Desktop-E, TANGO 3 mini, Desktop HE, TANGO PCIE21.**

Response: Output frequency [Hz] for precise frequency output mode.

Examples:
!trigbf 0.01 Set secondary trigger frequency to 0.01Hz
!trigbf 50000005 Set secondary trigger frequency to 50.000005 MHz
?trigbf Read the secondary trigger frequency (e.g. returns 1000.000)

25.13. trigcount (Trigger Counter)

Syntax: !trigcount or ?trigcount
Parameter: 0 to 2147483647

Description: Read or set the trigger event counter.
Trigcount increments on every executed trigger pulse.

Response: Number of executed triggers

Examples:

?trigcount Read trigger counter
!trigcount 0 Clear trigger counter
!trigcount 110 Set trigger counter to 110 counted events

25.14. trigger (Force Trigger Signal)

Syntax: !trigger or trigger
Parameter: None or 0 to 127

Description: This instruction generates one trigger output pulse or a fixed amount of pulses, refer to description below.
Manual trigger is available in manual **trigger modes** 102 and 103 only. The pulse width depends on **trigs** setting.

From TANGO Firmware 1.60C / 1.61 it is also possible to manually generate a fixed number of 1 to 127 trigger pulses by calling the instruction with an additional count parameter. The pulse frequency depends on the **trigf** setting.

Remarks: When executing multiple triggers (trigger was called with parameter), the function does not return until all trigger pulses are executed (the command interpreter is blocked). To identify if the instruction completed - and that the TANGO controller is able to receive new instructions - it is recommended to send an ?err request and wait for it to return.
→ Refer to Example 2(b).

Response: None

Example1: trigger (Force one trigger pulse now)

Example2: (requirement is at least TANGO Firmware 1.60C or 1.61)

```
!trig 0 (Disable trigger)
!trigf 1000 (Set frequency of trigger signal in Hz)
!trigs 400 (Set duration of trigger pulse in µs)
!trigm 102 (Set trigger mode to manual trigger 102 or 103)
!trig 1 (Enable trigger)
```

trigger 5 (Manually force 5 trigger pulses at 1000 Hz)

Example2(b): err → 0 (Optional wait for trigger function to complete by waiting for err response, e.g. zero)

25.15. trigr (Set Trigger Range)

Syntax: !trigr or ?trigr

Parameter: x, y, z, a or none
start position
end position
number of equidistant trigger signals within a position range

Description: Provides the *range trigger mode*, which
- begins and ends at defined positions
- generates a defined number of equidistant, unidirectional trigger signals (10000 max.)

Setting a trigger mode is not required, !trigr sets it to mode 20 (up) or 21 (down) automatically.

If no axis is specified, the trigger axis is used (?triga).
If an axis is specified (x,y,z,a) the trigger axis is set to this axis and remains set until changed.

Trigger signals are generated within a position range.
The scan direction is set by the start,end positions:
- start < end = trigger in positive travel direction
- start > end = trigger in negative travel direction

Start and end position units are defined by **dim**, e.g. mm.

The number of trigger signals defines their distance:
The first trigger is generated at the start position and the last trigger is generated at the end position (n+1).
e.g. to achieve 1mm distance from 0 to 10 mm = 11 signals.

If only one trigger position is specified (start = end), the trigger direction is determined from the current position:
- If the trigger position is greater than the axis position, the trigger direction is set to positive (up, forward).
- If the trigger position is lower than the axis position, the trigger direction is set to negative (down).

Once set, the trigger range remains and is reactivated automatically when the axis travels back behind the start position. If required, !trigr can set new parameters ahead of every move instruction.

For bidirectional scans, !trigr must be set to the required travel direction before each move (from pos -> to pos).
The move must start from below the start position and travel past the end position.

Remarks: The signal polarity for this special trigger mode can be set by the **!trigl** instruction.
In order to apply the signal polarity immediately, the trigger mode can be set to **!trigm** = 20 or 21 before setting **trigl**.

The trigr instruction clears and overwrites possibly existing **triggp** position lists of the specified axis and vice versa.
(!trigr internally writes its positions to the trigr list.)

Response: Currently applied values: [startpos] [endpos] [num of trigger]

Examples for trigr:

--- Preparation ---

- Globally disable the trigger:

```
!trig 0
```

- Select trigger polarity:

```
!trigm 20 (mode 20 or 21 to apply trigl immediately)
!trigl 1 (set trigger signal level to active high)
```

- Specify the axis:

```
( !trigenc 1 ) (optional if the axis provides an encoder)
!triga x (can also be specified or changed by !trigr)
```

--- Trigger ---

- A) Trigger in positive direction:

```
!moa 9 (move X to position below the trigger range)
!trigr 10 20 11 (one trigger every mm, 10,11,12,...20)
!trig 1 (globally enable the trigger**)
!moa 21 (move X to position past the trigger range)
```

- B) Trigger in negative direction:

```
!moa 21 (move X to position below the trigger range)
!trigr 20 10 11 (one trigger every mm, 20,19,18,...10)
!trig 1 (globally enable the trigger**)
!moa 9 (move X to position past the trigger range)
```

- C) Single trigger position:

```
!moa 19 (move X to position below the trigger range)
!trigr 20 20 1 (one trigger at 20mm)
!trig 1 (globally enable the trigger**)
!moa 21 (move X to position past the trigger range)
```

```
!trigr y 11.5 16 10 (select y axis for trigger from 11.5 to 16)
```

```
!trigr 11.5 16 10 (use recently set axis for trigger)
```

```
?trigr → 11.5000 16.5000 11 (read trigger settings)
```

```
?triga → y
```

** Trigger should be globally disabled for the initial configuration and may remain enabled afterwards, even if the !trigr parameters are modified.



Trigger Range Functionality (!trigr)

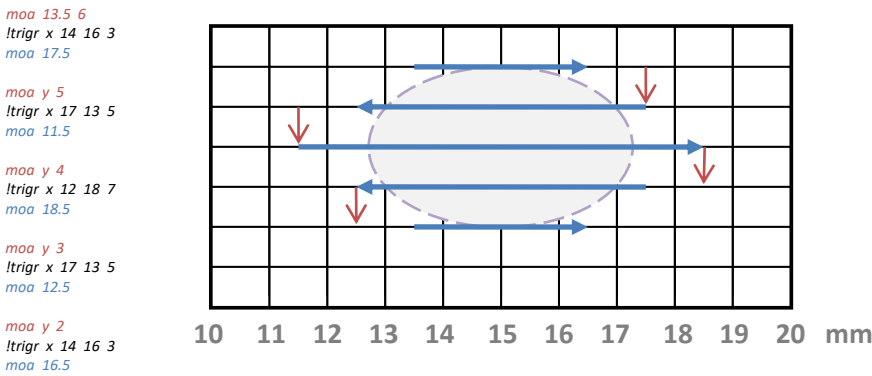
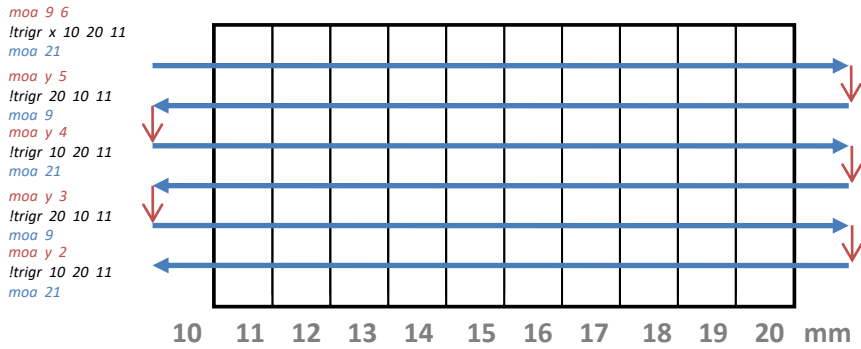
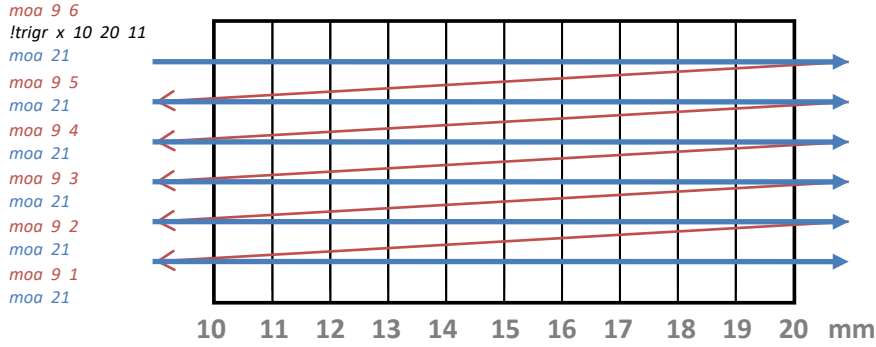
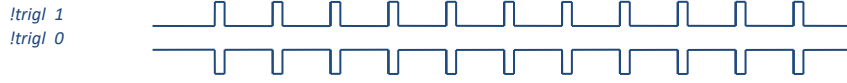

25.16. **trigp** (Trigger Position List Entry)

Syntax: !trigp or ?trigp
Parameter: none or x, y, z, a
 List index and position value

Description: Provides a list of individual, unidirectional trigger positions. The position unit depends on **dim** (mm, μ m, ...). Up to 10000 list entries are possible.

Setting a trigger mode is not required. !trigp sets **trigm** to mode 20 (up) or 21 (down) automatically.

The entries are only valid for the specified axis. If the axis has to be changed, all entries must be rewritten to the list.

If no axis is specified, the trigger axis is used (**triga**). If an axis is specified (x,y,z,a) with the first entry or when clearing the list, the trigger axis (**triga**) is set to this axis and remains set until changed. Later attempts of change are ignored and an error will be returned.

Trigger signals are generated at the specified position(s). The entries must be either of increasing or decreasing value, as the scan direction is identified by the first two entries. In case of only one list entry, the direction is determined from the current axis position here or when '!trig 1' is set:

- If the trigger position is greater than the axis position, the trigger direction is set to positive (up $\hat{=}$ **trigm** 20).
- If the trigger position is lower than the axis position, the trigger direction is set to negative (down $\hat{=}$ **trigm** 21).

Once set, the position list remains and is reactivated automatically when the axis travels back behind the first trigger position in the list. If required, the !trigp list can be loaded with new parameters ahead of every move instruction.

For bidirectional scans, !trigp must be filled in the required travel direction before each move (from pos -> to pos). The move must start from before the first trigger position.

```
!trigp 0           Discard the entire position list
!trigp x 0         Sets !triga to X axis and discards the X list
!trigp -1 2.5      Append a position to the list (here e.g. 2.5 mm)
!trigp x -1 9      Only possible if the list is empty (trigc=0):
                  Set the first position and select trigger axis
!trigp 1 5.3      Set or modify the first list entry (here 5.3 mm)
!trigp 5 9.1      If entries >= 5: Replace the 5th list entry
                  If entries = 4: Append entry (like -1 does)
?trigp -1         Read back the last entry on the list
?trigp 7          Read back the 7th list entry
```

Remarks: The signal polarity for this special trigger mode can be set by the '!trigl' instruction.

The number of entries can be read by the 'trigc' instruction.

In order to apply the signal polarity immediately, the trigger mode can be set to !trigm = 20 or 21 before setting trigl.

Response: Requested trigger position list entry in the current **dim**

Examples for trigp:

--- Preparation ---

- Globally disable the trigger:

```
!trig 0
```

- Select trigger polarity:

```
!trigm 20 (mode 20 or 21 to apply trigl immediately)
!trigl 1 (set trigger signal level to active high)
```

- Specify the axis:

```
( !trigenc 1 ) (optional if the axis provides an encoder)
!triga x (can also be specified or changed by !trigp)
```

- Empty the position list

```
!trigp 0 (if required, appending is also possible)
(remove all existing entries from the list)
```

--- Trigger ---

- A) Trigger in positive direction:

```
!moa 105 (move X to position below the trigger range)
!trigp -1 110.5 (append a position value, here: first entry)
!trigp -1 125.7 (append a position value)
!trigp -1 200.3 (append a position value)
!trig 1 (globally enable the trigger**)
!moa 205 (here: move X past the last entry)
```

- B) Trigger in negative direction:

```
!moa 205 (move X to position above the 1st entry pos)
!trigp -1 200.3 (append a position value, here: first entry)
!trigp -1 125.7 (append a position value)
!trigp -1 110.5 (append a position value)
!trig 1 (globally enable the trigger**)
!moa 105 (here: move X past the last entry)
```

- C) Single trigger position:

```
!moa 105 (move X before the position)
!trigp -1 110.5 (set only one trigger position)
!trig 1 (globally enable the trigger**)
!moa 115 (move X to position past the trigger range)
```

```
!trigp y 11.5 (set y as trigger axis, overwrites !triga)
!trigp -1 11.5 (use recently set axis for trigger)
?trigc (read the number of list entries)
?trigp 1 (read the first trigger position entry)
?triga y (read the trigger axis)
```

** The trigger should be globally disabled for the initial configuration and while filling or modifying the trigger position list.

During a scan it is not necessary to disable/enable the trigger, as the trigger re-enables itself when the axis moves before the first position.



More examples for trigp:

```
!trig 0
!trigm 20
!trigl 1
!trigenc 1
moa 5
```

Globally disable the trigger
mode 20 or 21 to apply trigl immediately
set trigger signal level to active high
optional, set the encoder as trigger source

position the x axis below the 1st triggerpos

EXAMPLE1 (strict)

EXAMPLE2 (alternate)

```
!triga x
!trigg 0
!trigg 1 10
!trigg 2 10.5
!trigg 3 11
!trigg 4 11.5
!trigg 5 12
1)
!trigg 6 20
!trigg 7 20.5
!trigg 8 21
!trigg 9 21.5
!trigg 10 22
1)
!trigg 11 30
!trigg 12 30.5
!trigg 13 31
!trigg 14 31.5
!trigg 15 32
```

```
!trigg x 0
!trigg -1 10
!trigg -1 10.5
!trigg -1 11
!trigg -1 11.5
!trigg -1 12
!trigg -1 20
!trigg -1 20.5
!trigg -1 21
!trigg -1 21.5
!trigg -1 22
!trigg -1 30
!trigg -1 30.5
!trigg -1 31
!trigg -1 31.5
!trigg -1 32
```

Select trigger axis and erase position list

Insert 1st trigger position

...

...

Insert last trigger position

The following instructions would now deliver:

```
?trigc => 15
?trigi => 1
?trigg 3 => 11.0000
?trigg x 3 => 11.0000
?trigg -1 => 32.0000
```

read the amount of entries
read the list index (here: at 1st entry)
read 3rd entry of trigger axis (here: X)
read 3rd entry of X (redundant information)
read last list position

It is possible to overwrite entries, e.g. !trigg 11 30.25

It is possible to shorten the list, e.g. !trigg 10 (=positions 30...32 ldeleted)

It is possible to append positions, e.g. !trigg -1 40.225

Which is the same as ?trigc → 15 !trigg 16 40.225

```
!trig 1
moa 37
```

Globally enable the trigger

Travel x past the last trigger position

Now 15 triggers are generated (examples here: 3 regions of interest with individual gaps inbetween).

1)

Important note: Sending a !trigg list to the TANGO cannot be done in one block. As with all instruction sequences, it must be ensured that the 256 byte input buffer does not run over (2nd gen. TANGOs have a larger buffer). Good practice might be to read back "err" or ?trigc after each !trigg position, at least every few !trigg positions. This will ensure no data gets lost during transmission and it was processed without error (was accepted with no error or count increased).

25.17. **trigc (Number of Trigger Position List Entries)**

Syntax: `!trigc` or `?trigc`

Parameter: none or [0 to `trigc`]

Description: Read the number of position list entries, which are made by **!trigp** or **!trigr**. Or reduce the position list size by specifying a lower amount of entries.

Remarks: Only for special trigger functionality of **!trigp** and **!trigr**.

Response: Amount of trigger position list entries.

Examples: `?trigc` (read the amount of trigger position list entries)
`!trigc 0` (clear the `trigp` position list)
`!trigc 5` (reduce the entries to 5, only possible if greater)

25.18. **trigi (Trigger Position List Index)**

Syntax: `!trigi` or `?trigi`

Parameter: none or 1 to 10000 (less or equal to the current **trigc** count)

Description: This instruction reads or sets the trigger position list pointer of the selected trigger axis (**triga**). The behavior is similar to `snsi` of the snapshot array, except the index here is consistent from 1 to N (`snsi` is 0...N-1).

In trigger modes 20 and 21 this pointer access can be used to read back where in the position list the trigger unit currently is. Or it can be used to manipulate the list index (position pointer) of the entries made by `trigp` or `trigr`.

The value must not exceed the amount of **trigc** list entries.

Response: Current trigger position list pointer

Example:
`?trigi` Read the current trigger position list pointer (e.g returns 1)
`!trigi 1` Set position list pointer to the first element
`!trigi` Same as `!trigi 1`
`!trigi 21` Set position list pointer to the 21st element

25.19. `trigl` (Trigger Level)

Syntax: `!trigl` or `?trigl`
Parameter: 0 or 1

Description: Select the trigger signal polarity for trigger modes 20 and 21 (**!trigr**, **!trigp** functionality).

0 = Trigger signal is active low
1 = Trigger signal is active high

Remarks: Only for special trigger functionality of **!trigp** and **!trigr**. For all other cases, the polarity is defined by their **trigger mode**.

Response: Trigger signal polarity for trigger modes 20 and 21.

Examples: `!trigl 0` (set to active low)
`!trigl 1` (set to active high)
`?trigl` (read trigger level, e.g. returns 1 = active high)

25.20. `trigsns` (Trigger from SnapShot Input)

Syntax: `!trigsns` or `?trigsns`
Parameter: 0 or 1

Availability: TANGO PCI-E/Desktop-E and Desktop HE, from Firmware 1.73.

Description: Generate a Trigger output signal when the AUX I/O SnapShot input changes from inactive to active. The input polarity can be set by **sns1**.

0 = Trigger on SnapShot disabled (default)
1 = Trigger on SnapShot enabled

Remarks: The `trigsns` function is available in each trigger mode. It adds trigger signals when a SnapShot event is detected. The SnapShot functionality does not have to be enabled. Only the default, dedicated AUX I/O SnapShot input can be Used. Other inputs assigned by **adiginfunc** are not used.

The SnapShot input is updated in a 40µs interval.
The input signal must be high for >40µs or low for >40µs in order to be safely detected.
The trigger signal will be generated a few µs after Detection.

Response: Enable State of the SnapShot→Trigger function (0 or 1).

Examples: `!trigsns 1` (enable)
`!trigsns 0` (disable)
`?trigsns ==> 0` (read the current state, here: disabled)

26. The Second Trigger Signal Output

26.1. Introduction

TANGO PCI/PCI-S/PCI-E TANGOS, Desktop TANGOs and the TANGO 3 mini provide two trigger output signals on the AUX I/O connector (TRIGGER_OUT, TAKT_OUT). Only the PCI-E, Desktop-E and TANGO 3 mini support the full functionality as described in this chapter.

Depending on the **trigger mode**, the output signals are active high or active low. This description shows the trigger signals in active high mode.

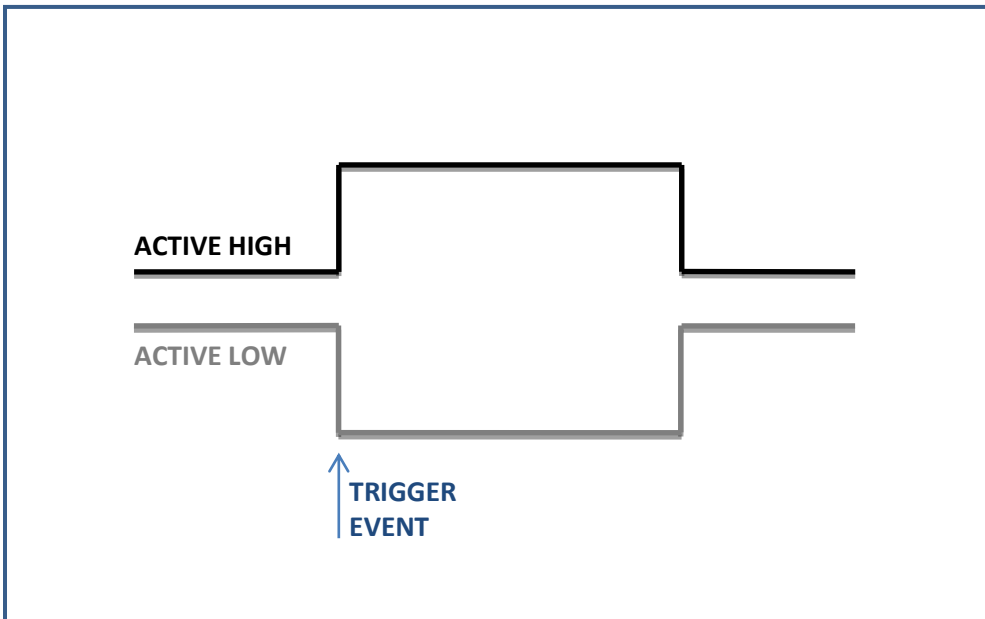

Up to two output signals are available and can be selected with the `'trigo'` instruction:

- TRIGGER_OUT (here called OUT1)
- TAKT_OUT (here called OUT2)

OUT2 is provided by PCI/PCI-E or Desktop TANGOs and TANGO 3 mini only.

Both outputs share the same polarity setting and trigger source.

The optional LED100 illumination uses OUT2.

The minimum OUT1 width of 40µs results in 12.5 kHz max. signal frequency. If the OUT1 signal width is set to zero, a short spike is still generated. This allows edge trigger events of up to 25 kHz.

26.2. Standard 1:1

Signal: OUT2 provides the same signal as OUT1 plus optional delay and width

Options: When the **trigs** signal width instruction is sent with 3 parameters, OUT2 provides the option of a delay and individual width. OUT2 becomes inactive latest when OUT1 returns to inactive state. OUT2 must be within the active range of OUT1.

Remarks: Can be used with any **trigger mode**.
 Parameter in increments of 40µs (0; 40; 80; ... 2,500,000)
 Values inbetween the 40µs get rounded to nearest, e.g. <20=0, ≥20=40

Application: Camera shutter and LED flash

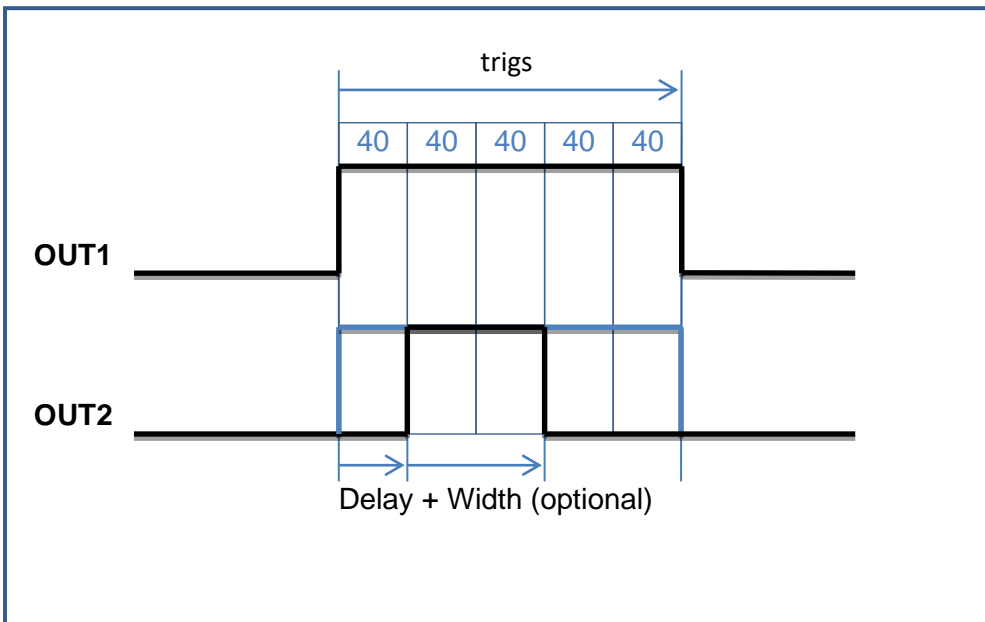

OPTIONS

- `!trigo 1` → OUT1 only, OUT2 set to inactive level
- `!trigo 2` → OUT2 only, OUT1 set to inactive level
- `!trigo 3` → OUT1 and OUT2

EXAMPLE

- `!trigo 3`
- `!trigs 200 40 80` → Set OUT1 signal width & maximum duration (200µs), Delay (40µs) and Width (80µs) for OUT2
- or `!trigs 200` → Set OUT1 and OUT2 signal width to 200µs

26.3. Precise Width

Signal: OUT2 starts with OUT1 but has individual, high resolution width.

Remarks: Can be used with any **trigger mode** of OUT1.
OUT2 resolution is in 7.6ns steps, up to 32.5 seconds.
OUT2 width can be longer than OUT1.

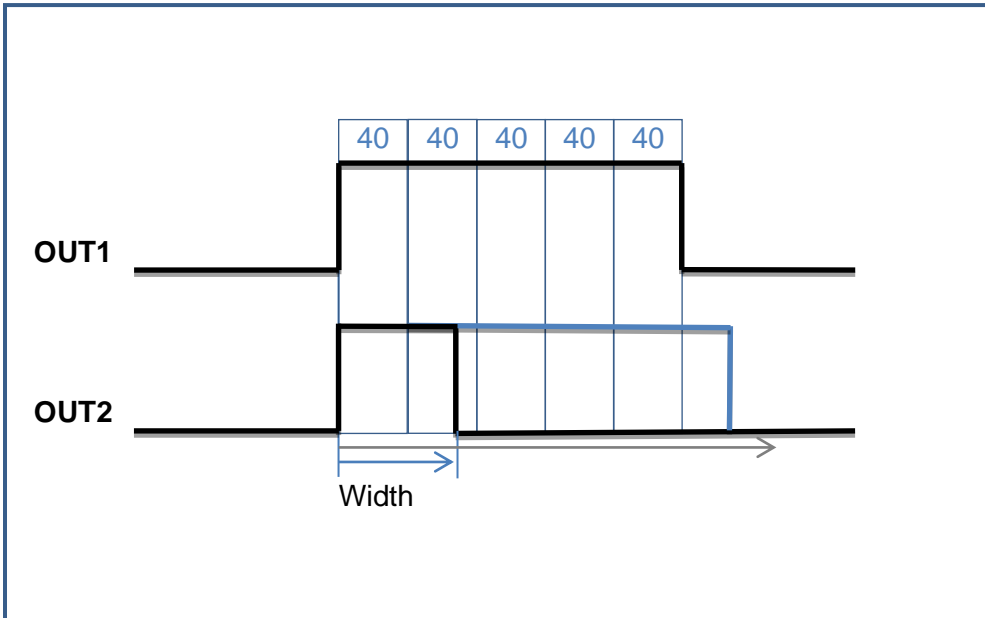

OPTIONS

`!trigo 5` → OUT1 only, OUT2 set to inactive level
`!trigo 6` → OUT2 only, OUT1 set to inactive level
`!trigo 7` → OUT1 and OUT2

EXAMPLE

`!trigo 7`
`!trigs 200`
`!trigbwidth 67.4` or `!trigbwidth 230`

26.4. Precise Delay

Signal: OUT2 provides a precise edge delay to OUT1.

Remarks: Can be used with any trigger mode of OUT1.
 Very low jitter between the two edges OUT1 → OUT2 <10ns.
 OUT2 resolution is in 7.6ns steps, up to 32.5 seconds.
 OUT2 delay can be longer than (past) the OUT1 signal width.

If the OUT2 pulse starts at last 1µs before the OUT1 pulse ends, then the OUT2 pulse is resetted with the OUT1 pulse.

Else the OUT2 pulse is resetted with the next 40µs interval.
 In this case, OUT2 signal widths of 100ns to 40µs may occur which makes only sense in edge triggered applications. Refer to the third OUT2 pulse “!trigbdelay 159.7” in the figure below.

Application: Precisely delayed trigger edges for transducer and receiver

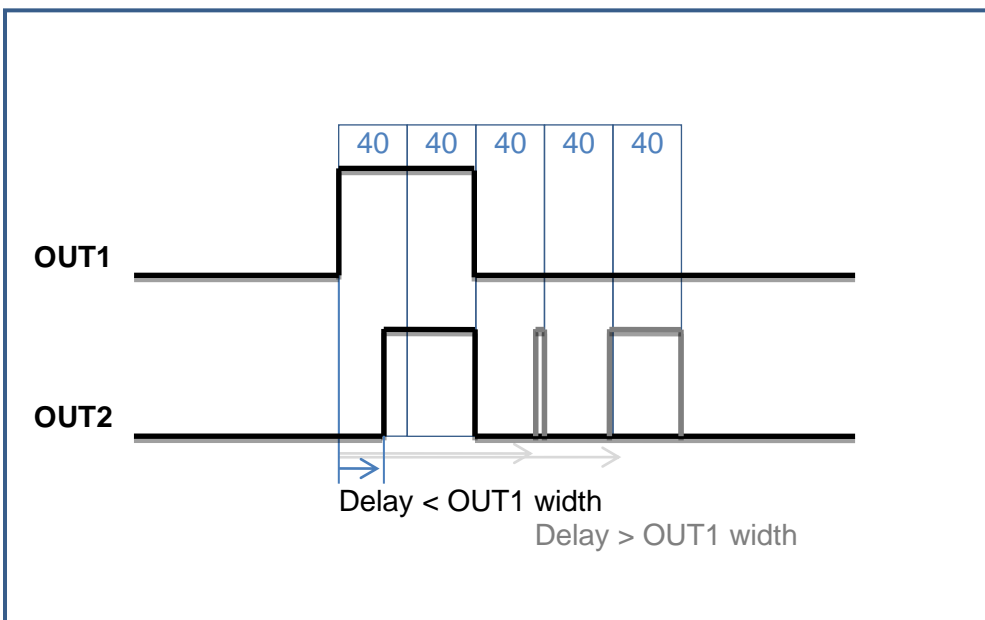

OPTIONS

- `!trigo 9` → OUT1 only, OUT2 set to inactive level
- `!trigo 10` → OUT2 only, OUT1 set to inactive level
- `!trigo 11` → OUT1 and OUT2

EXAMPLE

```
!trigo 11
!trigs 80
!trigbdelay 25.5 or !trigbdelay 112.03 or !trigbdelay 159.7
```

REMARKS

The TANGO PCI-S and Desktop-S controllers provide limited delay functionality. Here only the leading edge (active high = rising, active low = falling edge) of OUT2 is valid. The signal level inbetween is on active level (not inactive as shown above). When using those controllers, the delay function only makes sense with edge sensitive devices and not with level sensitive ones.

26.5. Precise Frequency

Signal: OUT1 and OUT2 provide individual output frequencies.
OUT2 can be used for higher frequencies and high resolution.

Remarks: OUT1 can run in an individual trigger mode (position dependent, etc.)
OUT1 width can be specified by 'trigs'
OUT1 frequency is limited to 0.01 to 25000 Hz and 1/40µs resolution
OUT2 provides 0.010...66,000,000 Hz high resolution and low jitter
OUT2 has fixed width of 50%
OUT1 and OUT2 are in phase only if the frequencies match (multiples)

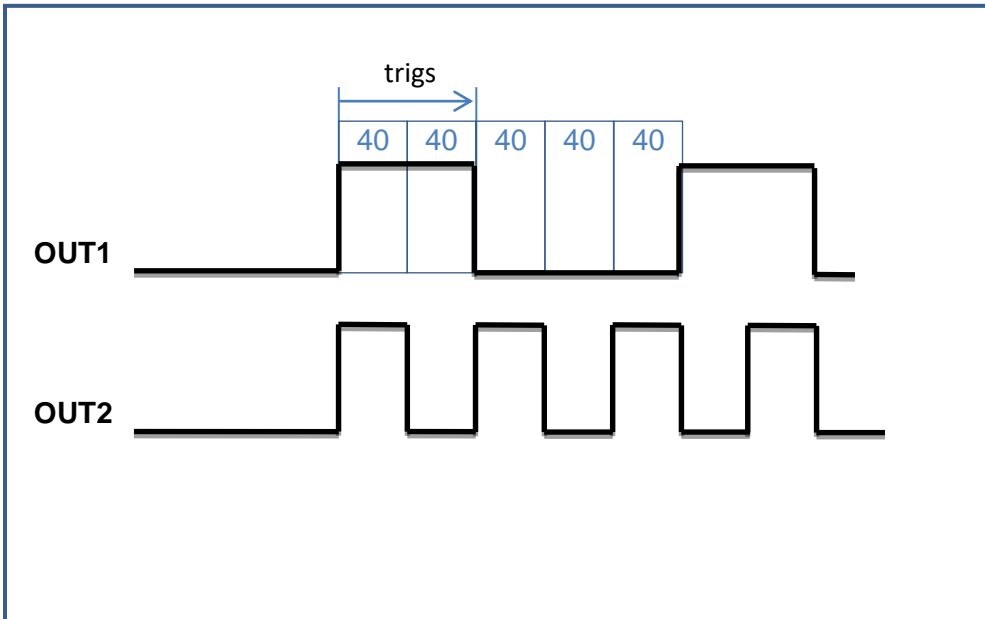

OPTIONS

`!trigo 13` → OUT1 only, OUT2 set to inactive level
`!trigo 14` → OUT2 only, OUT1 set to inactive level
`!trigo 15` → OUT1 and OUT2
!trigm can be set to an independent behavior, must not be frequency output

EXAMPLE

```
!trigo 15
!trigs 80
!trigf 5000
!trigbf 12500
!trigm 100
```

27. Snapshot – The Trigger Input Functionality (option)

Snapshot functionality must be configured by factory.

To identify if the Snapshot functionality is configured, use `?det` or `detext`.

The snapshot functionality allows capturing of X,Y,Z,A axis positions by either pressing a HDI key (e.g. Joystick F2), an external signal or a trigger-out event. Hardware dependent, analog input signals from the AUX I/O connector are captured as well. The values are appended to the snapshot array. The snapshot array can also be filled, extended or manipulated by `snsa`, `!snsp` instructions. Please refer to `snsnm` for available snapshot modes and `snsnm` for wrap modes*.

In `snsnm 1` and `5`, a snapshot event can command the TANGO controller to move to positions stored in the snapshot array. Every snapshot event goes to the next array entry and wraps around* at the end of the array. It can i.e. be used to move to positions (points of interest) captured in snapshot mode `snsnm 0` or `4`.

In `snsnm 6`, move and speed instructions, e.g. `moa`, `mor`, `speed` and `go`, wait for a snapshot event on the specified `snsaxis`.

The snapshot event can be triggered by either

- A) the Joystick key F2 (refer to chapter 18 "Joystick Function Key Assignments")
- B) via the SnapShot signal input (depends on hardware, AUX I/O connector option)
- C) by a software instruction (`snse`), that mimics the F1-F4 joystick buttons

The position unit depends on the selected dimension (`dim`). The setting of `encpos` defines if the motor position or the measured encoder position is read from the array. A maximum of 1024 snapshot positions can be captured.

For changing the snapshot configuration please disable the snapshot (`!sns 0`) and then re-enable it (`!sns 1`) after all settings have been made.

Remarks:

Only 2nd generation TANGOs from firmware 1.77 allow storing of most settings (by `save`) and the snapshot position array (by `snsave`).

Requirements:

The TANGO controller must be ordered with this function enabled, as it is not available by default or might require additional hardware (e.g. connector).

The snapshot signal is sampled every 160µs (2nd gen. 40µs). For safe recognition, the signal active and inactive time must be at least the sampling interval plus 40µs (200µs or 80µs). Also refer to '`snsf`' for the debounce filter time.

Example: Three snapshot positions are captured with a 3 axis TANGO

Index	Position X	Position Y	Position Z	Position A
1	1.0000	1.2345	1.2345	0
2	2.1200	1.3520	0.9343	0
3	3.5900	1.9000	0.8341	0
4	<i>invalid</i>	<i>invalid</i>	<i>invalid</i>	<i>invalid</i>
5	<i>invalid</i>	<i>invalid</i>	<i>invalid</i>	<i>invalid</i>

...

1024	<i>invalid</i>	<i>invalid</i>	<i>invalid</i>	<i>invalid</i>
------	----------------	----------------	----------------	----------------

Here: `?snc → 3 ?nsa 2 → 2.1200 1.3520 0.9343 ?nsa y 1 → 1.2345`

27.1. sns (Snapshot enable/disable)

Syntax: !sns or ?sns
Parameter: 0 or 1

Description: Globally enables or disables the snapshot functionality. Firmware versions until 1.72, snapshot is globally enabled by default (sns=1 at power-on). From Firmware 1.73, the default is off (0) and can be configured by **snspreset**. Latched key pressed events or the **snsm=6** waiting state of a move is cleared when enabling/disabling the Snapshot (sns0,1).

0 = disabled
1 = enabled

Response: Snapshot state

Examples:
!sns 0 Disable snapshot
?sns Read snapshot enable state

27.2. snspreset (Preset for sns)

Syntax: !snspreset or ?snspreset
Parameter: 0 or 1

Availability: From Firmware 1.73

Description: Set or read the predefined power-up setting for **sns**. The TANGO will use it as preset value for sns after power-up or reset. Default = 0.

Remarks: Firmware Versions before 1.73 use sns = 1 as default, meaning the snapshot is globally enabled at power-up. From Firmware 1.73 it is possible to define the value for power-up or reset with snspreset. New Default = 0.

Response: Selected sns enable state for power-up.

Examples:
!snspreset 1 Set power-up preset for sns to 1 (globally enabled)
?snspreset Read the sns preset value

27.3. sns1 (Snapshot Level / Polarity)

Syntax: !sns1 or ?sns1
Parameter: 0 or 1

Description: This instruction sets the snapshot input signal polarity.
 0 = active low (event detected at falling edge)
 1 = active high (event detected at rising edge)

Response: Currently used snapshot polarity

Examples:
!sns1 0 Set snapshot input to active low (default)
?sns1 Read current snapshot input polarity

27.4. snsf (Snapshot Filter)

Syntax: !snsf or ?snsf
Parameter: 0 to 255 [ms]

Description: Reads or set the snapshot filter time in ms, which is used
 to debounce the snapshot signal (HDI F2 button or snapshot
 input). Default is 10ms. The filter time does not delay the
 reaction to the signal, it only delays the next detection
 of a signal change.

Requirements: The minimum high and low times of the input signal must be
 greater or equal to 200µs to be recognized (160µs+40µs).
 2nd generation TANGOs allow faster processing, where the
 signal can be 80µs (40µs+40µs) at minimum.

Remarks: Debouncing is recommended for push-buttons, switches, etc.
 For digitally generated signals, the filter time can be 0.

Response: Snapshot filter time

Examples:
!snsf 0 Disable input filter
!snsf 10 Set snapshot filter time to 10 ms
?snsf Read snapshot filter time in [ms]

27.5. sns (Snapshot Mode)

Syntax:	!snsm or ?snsm
Parameter:	0, 1, ... 12
Description:	<p>This instruction reads or sets the snapshot mode (default=0).</p> <p>0 = Capture positions to list with Joystick key F2</p> <p>1 = Move forward through position list with Joystick key F2 (wraps around at the last element)</p> <p>2 = Extended move with Joystick keys: F1: Move backward through position list (wraps around) F2: Move forward through position list (wraps around) F3: Move to 'prehome' then start of list (first element) F4: Move to 'prehome' with 'vel' then 'home' with 'sevel'</p> <p>3 = Simple continuous path control in conjunction with pre-loaded snsa/snsp positions (dissection mode). The path travel velocity is set by 'scanvel'. Start with Joystick key F2 or corresponding 'sns 2'. HDI must be enabled by joy and joydir = 2. 2nd gen. TANGOs offer an easier way by using "dissect".</p> <p>4 = Like mode 0, but snapshot I/O input is used instead of F2</p> <p>5 = Like mode 1, but snapshot I/O input is used instead of F2</p> <p>6 = Triggered start: Move and Speed instructions will wait for the I/O snapshot input event to start moving. Axes must be assigned by the 'snsaxis' instruction.</p> <p>7 = Custom HDI mode with Prehome, Home and auto increment in a time-interval set by the 'delay' instruction</p> <p>8 = A Trigger-OUT event (not a snapshot event) captures axis positions and the ANIN0 analogue signal of the optional AUX I/O connector available with some TANGOs, e.g. Desktop</p> <p>9 = Move relative 'snsj' Jump distances with Joystick keys F2 = jump, F1 = jump in reversed direction (back)</p> <p>10= Like mode 9, but snapshot I/O input is used instead of F2</p> <p>11= Z axis follows a Z(X) position list (e.g. focus for scan)</p> <p>12= A axis follows a A(X) position list (e.g. focus for scan)</p>
Remarks:	<p>F1-F4 key events can also be generated by 'sns 1' to 4.</p> <p>Position capture modes (0,4,8) also capture the analog voltage at the AUX I/O ANIN0 input pin. It can be read by '?snsv'.</p> <p>A snapshot capture is executed on all active axes. If the snapshot array is filled by snsa, it is possible to fill in individual axes x, y, z, a, which lets only those travel.</p> <p>When setting sns Snapshot mode, latched key events (key1) or a pending snapshot mode 6 waiting state is cleared.</p>
Response:	Currently selected snapshot mode
Examples:	<pre>!snsm 0 (Set snapshot mode to capture with joystick key F2) !snsm 1 (Set snapshot mode to move with joystick key F2) !snsm 8 (Set snapshot mode to capture at trigger out events) ?snsm (Read current snapshot mode)</pre>

27.6. Snapshot Mode Description and Examples

Snapshot Mode 1,2,3,7,9 move functions, accessible via Joystick F1-F4 keys or !snse 1-4 instruction:

Key	Mode function				
	1	2	3 (DISSECTION)	7 ***	9
F1 =	-	previous point**	-	prehome* & home	jump back
F2 =	next point	next point**	start dissection	auto inc from 1 st point	jump fwd
F3 =	-	prehome*& first point	-	pause/continue	-
F4 =	-	prehome*& home	-	pause & previous point	-

* Remarks: A move to the "prehome" positions always travels at **sevel**.

Prehome & home means that the axes move to prehome and from there to home.

This is used to avoid possible collisions on the way to the home position.

Prehome & first point means that the axes move to prehome and after reaching directly to the first position in the position list. This sequence is also for collision prevention.

If prehome is not required, it can be set to the same position as home.

For graphical explanation of home & prehome positions, refer to Figure 1 below.

** SnapShot mode 2:

F3 function must be executed (= go to first point) to enable the F1 and F2 functionality
F4 disables the F1 and F2 functionality (as it returns home), so pressing F3 is required again

Instruction sequence example for snsm 2:

```
!cal
!rm
!sns 0
!prehome [Xpos] [Ypos] [Zpos] [Apos]      (specify a redirection to avoid obstacles)
!home [Xpos] [Ypos] [Zpos] [Apos]        (specify home, e.g. load, unload position)
!snsa 0                                   (clear the snapshot array / position list)
!snsa 1 [Xpos] [Ypos] [Zpos] [Apos]      (load position list, at least one entry)
!snsa 2 ...                               (load position list) ...
... !sI N ...
!snsm 2                                  (enter snapshot mode 2 for F1-F4 functionality)
!sns 1                                   (activate snapshot function globally)
```

*** SnapShot Mode 7:

1. Execute a !cal and !rm instruction to define the repeatable, absolute position (origin).
2. Define the !prehome and the !home positions.
3. Define a position list of points using the !snsa instruction.
4. Specify a user delay between the positions by using the !delay instruction.
5. Enter snapshot mode 7 by sending the !snsm 7 instruction.

All information is lost when the TANGO controller is switched off or resetted.

The delay also applies to all move instructions. So when leaving the snapshot mode 7

it is recommended to reset the delay value back to zero (!delay 0).

Snapshot mode 7 uses the joystick keys F1 to F4 according this specification:

- F1 = Go to load/unload position (as defined with the !home and !prehome instructions)
- F2 = Start Auto Movement from Point 1 (through position list, defined by the !snsa instruction and using a delay as defined by the !delay instruction)
- F3 = Pause/Continue from current position (halt the automatic move)
- F4 = Move back one position in the list (when in pause, else it is paused after reaching the next position and then it moves back.)

Instruction sequence example for snsm 7:

```
!cal
!rm
!sns 0
!delay 3000                               (delay between moves, e.g. 3 seconds)
!prehome [Xpos] [Ypos] [Zpos] [Apos]      (specify a redirection to avoid obstacles)
!home [Xpos] [Ypos] [Zpos] [Apos]        (specify home, e.g. load, unload position)
!snsa 0                                   (clear the snapshot array / position list)
!snsa 1 [Xpos] [Ypos] [Zpos] [Apos]      (load position list)
!snsa 2 ...                               (load position list) ...
... !sI N ...
!snsm 7                                  (enter snapshot mode 7 for F1-F4 functionality)
!sns 1                                   (activate snapshot function globally)
```

Autoincrement can be aborted by the **abort (a)** instruction.

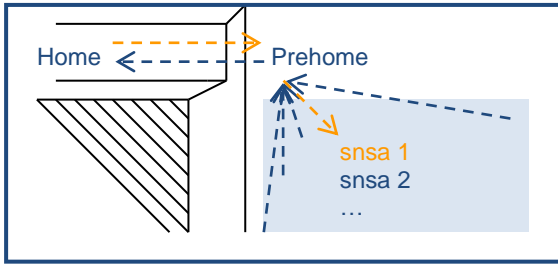

Figure 1: home & prehome (in modes 2 and 7)

Snapshot Mode 3 (dissection, simple continuous path functionality):

Typical applications are laser dissection or evaporation, or adhesive dosers/dispensers.

Remarks: All axes must be idle and all axis positions must be loaded with valid entries.

Joy and joydir must be enabled (e.g. set to 2) for all required axes (as with !speed).

The continuous path functionality has a continuous increase in position deviation

which will build up during the sequence. The interpreter is blocked during execution.

```

!scanvel [mm/s]           (set the path/vector velocity)
!sns 0                    (disable the snapshot)
!snsa 0                   (clear the snapshot array / position list)
!snsa -1 [Xpos] [Ypos] [Zpos] [Apos] (write first entry to position list, here: append)
?err                      (read back if accepted, also prevents buf.overflow)
!snsa -1 [Xpos] [Ypos] [Zpos] [Apos] (continue as above for all entries ...)
?err
...
!sns 3                    (enter snapshot dissection mode 3)
!sns 1                    (activate snapshot function)
!snse 2                   (start the dissection sequence, or press F2 key)
?err                      (send a request and wait for reply → completed)

```

Snapshot Mode 11 (X-Z focus list):

In snapshot mode 11, Z follows a position list dependent on the X axis position.

Typically used for focus applications under high magnification.

Best performance with piezo Z-stages, which are able to follow more precisely and at higher velocities.

The snapshot array can be loaded with X-Z position pairs of increasing X value.

The X distances can be random, no equal distance or match with e.g. trigger distances required.

When snsm 11 is activated, Z travels at interpolated positions between the X points.

X positions below the first snapshot array entry will cause Z to remain at the first Z position.

X positions higher than the last entry will cause Z to remain at the last Z position.

The Z positioning will begin as soon as the snapshot mode is activated.

Z then is controlled by the snapshot array position list.

The snapshot array positions of Y and A axes are ignored in snsm 11.

```

!sns 0                    (disable the snapshot)
!snsa 0                   (clear the snapshot array / position list)
!snsa 1 [Xpos] [don't care] [Zpos] (load X-Z position list first entry)
!snsa 2 ...               (load X-Z position list) ...
... !sI N ...
!sns 11                  (enter X-Z focus mode)
!sns 1                    (activate snapshot function again)
?err                      (send a request and wait for reply → completed)

```

```

Example: !snsa 1 5.1 0 2.33
         !snsa 2 7.1 0 5
         !snsa 3 11.7 0 1.65

```

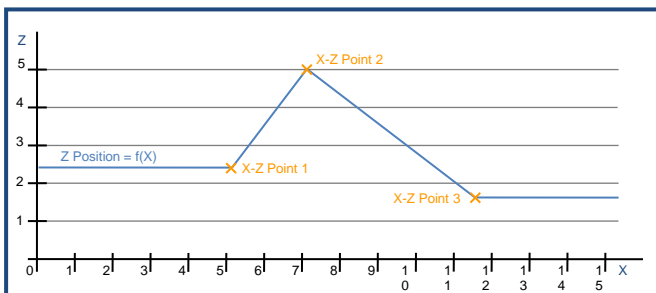

Figure 2: X-Z focus application (snapshot mode 11)

27.7. snsww (Snapshot Wrap-Around Modes)

Syntax: !snsww or ?snsww

Parameter: 0, 1, 2 or 3

Availability: From Firmware 1.78**

Description: Snapshot Wrap-around (circular, ringbuffer) modes. Activates or deactivates the wrap-around behavior of the snapshot capture (snsww 0+4) and move modes (smsm 1+5). The default behavior is snsww mode 2.

0 = no wrap-around

Even the move modes stop at the end(s) of the snapshot array.

1 = wrap-around for position capture only

2 = wrap-around for snapshot moves only (default)

3 = wrap-around for all, snapshot capture and move

Remarks: ** Only the 2nd generation TANGOs (e.g. Desktop HE) fully support this feature. 1st generation TANGOs (e.g. Desktop-E, PCI-E) only support the capture mode wrap-around (snsww 2<->3), the mode settings for move (0,1) are ignored.

Response: Current snapshot wrap-around modes setting 0-3

Example:

```
?snsww => 2      Read the wrap-around modes setting (here: is at the default)
!snsww 3        Enable ringbuffer mode for snapshot capture
!snsww 2        Disable ringbuffer mode for snapshot capture (default)
!snsww 0        Disable ringbuffer/wrap-around modes for all (2nd gen. TANGOs)
```

Use Case: Activating the wrap-around mode for position capture enables the application to endlessly capture positions without the need of a large buffer. The snapshot counter (snscc) indicates the most recent snsaa capture index. By asynchronously reading this "ring buffer", by following until the snscc index and wrapping around, all positions can be read in a continuous way.

```
!snsww 3
```

```
?snscc --> 812
```

```
?snscc --> 903
```

```
?snscc --> 13
```

```
?snscc --> 95
```

```
?snscc --> 166
```

```
?snscc --> 248
```

```
?snscc --> 326
```

```
?snscc --> 409
```

```
?snscc --> 476
```

```
?snscc --> 557
```

```
?snscc --> 246
```

```
?snsaa 244 --> 151.9363 303.7923 227.8749
```

```
?snsaa 245 --> 151.9379 303.7955 227.8773
```

```
?snsaa 246 --> 151.9395 303.7987 227.8797 ← latest entry
```

```
?snsaa 247 --> 150.3027 300.5251 225.4245 ← previous loop
```

27.8. `snc` (Snapshot Counter)

Syntax: `!snc` or `?snc`
Parameter: none, 0 or 1 to 1024 (not greater than the current `snc` count)

Description: This instruction reads or sets the snapshot counter, which shows the snapshot array entries (counted snapshot events). This instruction may also be used to reset the counter to zero or reduce the size of an existing array.

2nd generation TANGOs from firmware 1.77:
The counter value (and the `snsa` position array) can be stored with the **`!snsave`** instruction.

Response: Current snapshot array entries (number of snapshot events)

Example:
`?snc` Read the number array entries (e.g. captured snapshots)
`!snc` Clear snapshot counter to zero elements
`!snc 0` Clear snapshot counter (same as `!snc` without parameter)
`!snc 50` Reduce snapshot array entries to 50 (only if the current `snc` value is equal or higher than the new value)

27.9. `snsi` (Snapshot Index)

Syntax: `!snsi` or `?snsi`
Parameter: none or 0 to 1023 (less than the current `snc` count)

Description: This instruction reads or sets the snapshot array pointer.

In snapshot modes 1 and 5 this pointer access can be used to manipulate the array index where move target positions are read from.

Opposed to other snapshot instructions the index range here is `[0...N-1]` instead of `[1...N]`. The value must be less than the amount of **`snc`** array entries.

Remarks: The pointer is only used for the snapshot move. It does not define the array index where positions are written to. Captured positions are always appended as the last element of the array. For array manipulations by software please refer to **`'snsa'`** and **`'sncp'`**.

Response: Current snapshot array pointer used for snapshot moves

Example:
`?snsi` Read the current array pointer position
`!snsi 0` Set array pointer to the first element
`!snsi` Same as `!snsi 0`
`!snsi 20` Set array pointer to the 21st element

27.10. snsaxis (Snapshot Axis)

Syntax: !snsaxis or ?snsaxis
Parameter: x, y, z, a or none
 0 or 1

Description: Select axes for triggered start (Snapshot Mode 6).
 Snsaxis defines which axes should wait in Snapshot Mode 6.
 Please refer to '**sns**' for further information.
 When sending **moa**, **mor**, **moe**, **moc** or **speed** in Snapshot Mode 6,
 axes can be specified that should not execute the move until
 triggered by a snapshot-in event. This can be used in cases
 where precise start timing has to be controlled by an external
 signal.

1 = move or speed of this axis will wait for snapshot signal
0 = axis does not wait for snapshot signal (default operation)

Remarks: If not all axes are set to waiting mode, a vector move may
 start some of the axes while the others are waiting.
 When using single axis move or speed instructions, such
 problem does not exist.

Response: Wait mode setting of the axes

Example:

```
!snsaxis 1 0 1     Set axis X, Z to waiting mode, Y does not wait
!snsaxis y 1       Set axis Y to waiting mode
?snsaxis           Read waiting mode of all available axes (e.g. returns "0 0 0")
?snsaxis z         Read waiting mode of Z axis only (e.g. returns "1")

!snsm 6
!snsaxis 1 0 1
!sns 1
!moa z 2           The Z move will not execute until the snapshot signal is valid
!moa 5             The X move will not execute until the snapshot signal is valid
!moa y 5           The Y move will execute as usual, no waiting
!moa 10 10         A vector move in X+Y is started → In such case, here only X
                    will wait for the snapshot, but Y will travel.
```

27.11. snsp (Snapshot Position)

Syntax: !snsp or ?snsp

Parameter: x, y, z, a or none
Positions (unit depends on '**dim**')

Description: Read the last captured Snapshot Position or append a new snapshot array (snsa) position.
When appending a new snapshot positions by '!snsp', the snapshot counter '**sns**' is incremented automatically.

Snsp always returns the last captured position, even if the snsa array is full / snsc reached the max. value.

Remarks: Only motor positions can be read.
For reading a captured encoder position, please refer to '**?snsa -1**'. Snsa captures up to 1024 positions, when the Snapshot counter snsc is not cleared. Then snsa stops capturing (except in circular buffer mode **sns** 2 and 3).

Response: Last captured Snapshot position(s) of the specified axis or of all available axes. The unit depends on '**dim**', the resolution on the '**resolution**' setting.

Examples:

?snsp	Read last captured snapshot position of all axes
?snsp z	Read last captured snapshot position of Z axis only
!snsp 8.5 50.2	Append a new X and Y entry (then only X and Y axes will be used for positioning, Z and A will remain at their positions)
!snsp y 20.5	Append a new position entry with Y-axis position only

27.12. snsas (Snapshot Array)

Syntax: !snsas or ?snsas
 Parameter: x, y, z, a or none
 -1, 0 or 1 to 1024 and up to 4 positions in the current 'dim'

Description: Read, fill, modify or clear the snapshot position array, which may contain up to 1024 entries. For reading a valid entry, the index must be -1 or -2, or a value between 1 and the snapshot counter value '?snc':

<u>Index</u>	<u>Function</u>
0	clear the entire array (also sets snc to 0)
1...1024	r/w access to the corresponding array entry
[snc+1]	like -1, an index of the number of entries +1 can be used to append a new entry
-1	read the last entry or append a new entry
-2	list all entries (2 nd gen. TANGOs only)

2nd generation TANGOs from firmware 1.77:
 The snapshot position array (and the snc counter value) can be stored with the **sncsave** instruction. And supports index -2.

Remarks: Captured positions can be read as motor- or encoder positions, depending on the 'encpos' setting. Axes without encoders or array entries written by software (via !snsas or !snc) only return the motor position. When the snapshot array is used to position axes on snapshot events (e.g. by **snc** 1), axes will travel as follows: If the array was filled by capturing positions (e.g. **snc** 0), Then all axes will travel to the captured position. If the array was filled by software, via !snsas or !snc, then only the specified axes will travel, others are not affected. Refer to examples below. **Snapshot modes 11 and 12** provide a focus map function, where the Z or A axis automatically follows the paired X and Z (11) or X and A (12) entries in the snapshot array. Only the corresponding X+Z or X+A entries are used, the other entries are ignored.

Response: Snapshot array position(s) in 'dim' units.

Examples:

```
!snsas 0          Clear the entire snapshot array
!snsas -1 8.5 50.2 Append a new entry X+Y → for this entry, only X+Y axes will travel
!snsas z -1 20.5  Append a new entry for Z → here only Z will travel

!snsas 2 50 50 2.8 7 Set or overwrite all 4 axis positions of the 2nd array entry

?sncas 1          Read all axis positions of the first snapshot entry
?sncas -1         Read all axis positions of the last snapshot entry
                 Which is the same as the combination of ?snc+?sncas:
?snc ==> 10      Read entries to get the index
?sncas 10         And read all axis positions of the last snapshot entry

?sncas z 99       Read the Z-axis position of the 99th snapshot entry
?sncas y -1       Read the Y-axis position of the last snapshot entry

?sncas 0          Not valid, the snsas index starts from 1

?sncas -2         2nd gen. TANGOs from firmware 1.77 offer listing the entire array,
                 line by line, the last line is "SNSAS_END.".
?sncas z -2       2nd gen. TANGOs from firmware 1.77: list all Z-axis entries
```

27.13. snsamp (Snapshot Array Encoder Amplitude)

Syntax: ?snsamp or snsamp
Parameter: x, y, z, a or none
 -1, -2 or 1 to 1024

Availability: 2nd generation TANGOs (e.g. Desktop HE) from Firmware 1.79.

Description: Read the encoder amplitudes of the snapshot array. Axes with encoders store the values in parallel to the position, snsamp allows access to this information. The options for reading are identical to the "snsa" instruction, only the set "!" functionality is not available. If an axis has no encoder, the returned amplitude is 0.0. As the snsamp is read only, the leading "?" is not required.

For reading a valid entry, the index must be -1 or -2, or have a value between 1 and the snapshot counter value '?snc':

<u>Index</u>	<u>Function</u>
-2	read the entire array at once (multi-line)
-1	read the last entry
1...1024	read the corresponding array entry

Response: Snapshot array encoder amplitude(s) in %
 with one fractional digit.

Examples:

```
?snsamp 1                Read all axes encoder amplitudes of the first snapshot entry
?snsamp -1               Read all axes encoder amplitudes of the last snapshot entry
                          Which is the same as the combination of ?snc+?snsamp:
?snc ==> 10              Read entries to get the index
?snsamp 10               And read all axis amplitudes of the last snapshot entry

?snsamp z 99 ==> 81.3    Read the Z-axis amplitude of the 99th snapshot entry
?snsamp y -1 ==> 67.8    Read the Y-axis amplitude of the last snapshot entry

?snsamp 0                Not valid, the snsa and snsamp index starts from 1

?snsamp -2               list the entire array line by line , the last line is "SNSA_END.".
?snsamp z -2             list all Z-axis entries line by line, the last line is "SNSA_END.".

?snsamp -2    ==>   67.3 71.8 80.5               (example for a 3-Axis TANGO with 3 encoders)
                  67.0 72.1 81.2
                  65.8 72.4 81.8
                  65.6 72.3 80.9
                  64.9 71.9 79.7
                  64.1 70.8 80.1
                  SNSA_END.

?snsamp z -2 ==>   80.5
                  81.2
                  81.8
                  80.9
                  79.7
                  80.1
                  SNSA_END.
```

27.14. create (Create a Snapshot Array Position List)

Syntax: !create or create
Parameter: c
And further parameters depending on the selected type

Availability: 2nd generation TANGOs (e.g. Desktop HE) from Firmware 1.77.

Description: Creates a position list for several types of move pattern, such as line, vector, meander, circle, rectangle, etc. Where the circle might be useful for dissection/dispenser mode (snsm 3 or the **dissect** instruction), and the line, vector or meander can be used for scans. The positions are written to the snapshot array (snsa), the number of entries is usually the requested number of steps plus one, as the first entry is the start position, it can be read by ?snsnc, the position values by ?snsa.

Currently, only the circle function (c) is supported:

Type

c = Circle (from 12 o'clock - forward or backward)

The position, length and distance units are in the current **dim** of the individual axes. The circle radius is in the dim of the x-axis.

Circle (c)

Around the current position, around a specified XY-position or from the current position (if specified PosX & PosY = -1) Optional with a specified number of steps (without, a useful number of steps will be calculated internally) At least 4 steps must be specified, which generates a rhombus. A negative radius creates a counter-clockwise circle.

```
create c [radius]
create c [radius] [Steps 4...1023]
create c [PosX] [PosY] [Radius]
create c [PosX] [PosY] [Radius] [Steps 4...1023]
```

Remarks: The create function can replace the external generation of positions and loading/replacing them in the snapshot array. It is also useful for **Macro** functions, because long position lists or move pattern would use up macro space, while create will be more compact and allow the macro to fit in.

Response: none.

Examples:

```
create c 5.5 (Creates a circle with radius 5.5 mm around the current position)
?snsnc ==> 684 (as no steps were specified, a useful list of 684 points was created)
```

```
create c 10 20 7 (Creates a circle with radius 7 mm around the position X=10, Y=20)
?snsnc ==> 720 (as no steps were specified, a useful list of 720 points was created)
```

```
create c 10 20 7 360 (7 mm circle around X=10, Y=20 of 360 steps = 1 degree steps)
?snsnc ==> 361 (360 steps were created, count is +1 because of the start position)
```

```
create c -5 (5mm circle, counter-clockwise)
create c -1 -1 5 (5mm circle, clockwise, starting from the current axis-position)
```

27.15. snse (Snapshot Event)

Syntax: !snse or snse
Parameter: 1, 2, 3 or 4

Description: Executes HDI F-key Snapshot functions via the communication interface. Instead of pressing a Joystick button or using the AUX I/O signal, the functions can be triggered by software:

- 1 = Function normally executed by pressing Joystick F1 key
- 2 = Function normally executed by pressing Joystick F2 key or using the AUX I/O SnapShot input
- 3 = Function normally executed by pressing Joystick F3 key
- 4 = Function normally executed by pressing Joystick F4 key

Remark: Behavior is the same as with the function keys. It depends on the snapshot mode settings and only works when Snapshot is enabled.

Response: -

Example:
snse 2 Execute F2 Snapshot event (e.g. capture current position to the snapshot position array)

27.16. snsV (Snapshot Voltage)

Syntax: !snsv or ?snsv
Parameter: 1 to 1024 or -1 to -1024

Description: Read the AUX I/O ANIN0 input voltage (0...5V) captured at the specified position array index. The value can also be written to (e.g. as temporary data storage)
Index > 0: read Voltage in [mV]
Index < 0: read raw ADC data

Remarks: The specified index must be in the range of ± 1 to $\pm \mathbf{snsc}$. The [mV] values are always calculated with the internal voltage reference, while the raw data is the direct ADC sampling result which may be less accurate (PCI-E based and 2nd gen TANGOs have an accurate ADC sampling result). The raw data range is always 12bit, but with PCI-S based controllers the 2 LSBs are always zero (10bit resolution).

Response: Voltage in [mV] or in [12bit ADC raw data]

Example:
?snsv 2 Read captured Voltage [mV] of 2nd snapshot array entry
?snsv -2 Read captured Voltage [raw] of 2nd snapshot array entry
!snsv 5 1234 Store the value 1234 in 5th snapshot array voltage element

27.17. snsj (Snapshot Jump)

Syntax: !snsj or ?snsj
Parameter: x, y, z, a or none
 Positions (unit depends on '**dim**')

Description: Sets the jump distance for snapshot-initiated relative moves.
 The unit of the position depends on the '**dim**' setting.
 Depending on the snapshot mode '**snsm**', the jump is executed
 either by HDI (e.g. Joystick) function keys or via the AUX I/O
 snapshot input:

snapshot mode **snsm** 9:

- HDI F2 key = jump (move relative) in the specified direction
- HDI F1 key = jumps in the opposite direction (backwards)
- The **sns** 1 and **sns** 2 instructions can be used also

snapshot mode **snsm** 10:

- AUX I/O snapshot input jumps in the specified direction only

Remarks: Only 2nd generation TANGOs from firmware 1.77 store the snsj
 positions (by the regular **save** instruction).

Response: Position value(s)

Examples:

!snsj z 1.5 Set the jump distance for Z axis to 1.5 (mm if dim= 2 or 9)
!snsj 1 -10 0 0.2 Set the jump distance for all axes (here Z does not move)
?snsj y Read the jump distance of the Y axis
?snsj Read the jump distance of all axes

27.18. prehome (Snapshot PreHome Position)

Syntax: !prehome or ?prehome

Parameter: x, y, z, a or none, position value(s) in current dim

Description: This instruction sets the prehome position used by the extended move. The position unit depends on the '**dim**' setting.
Remarks: Firmware before 1.77 and all 1st generation TANGOs perform a prehome move on all available TANGO axes.

2nd generation TANGOs from firmware 1.77:

Only the here sent prehome axis positions are used for the prehome move. Not sent positions or positions which are set to 0 will be ignored by the prehome move to allow definition of individual prehome-affected axes.

e.g. !prehome 10 20 will cause a prehome move only in X+Y,
!prehome 10 0 20 will cause a prehome move only in X+Z
!prehome y 5.5 will add a Y-axis move to prehome and
!prehome z 0 removes the Z-axis from prehome moves.
!prehome 0 deletes all prehome positions.

The positions are stored by the regular save instruction.

Remarks: Used in snapshot modes (**sns**m) 2 and 7.

Response: Position value(s) depending on dim and number of axes

Examples:

!prehome y 10.2 Set prehome position Y-value to 10.2 (e.g. [mm] when dim=2)

!prehome 10 0 20 Set prehome position X,Y,Z

?prehome x Read currently used prehome position of X axis only

?prehome Read currently used prehome positions of all axes

27.19. home (Snapshot Home Position)

Syntax: !home or ?home

Parameter: x, y, z, a or none, position value(s) in current dim

Description: This instruction sets the home position used by the snapshot extended move. The position unit depends on the '**dim**' setting.
Remarks: Firmware before 1.77 and all 1st generation TANGOs perform a home move on all available TANGO axes.

2nd generation TANGOs from firmware 1.77:

Only the here sent home axis positions are used for the home move. Not sent positions or positions which are set to 0 will be ignored by the home move to allow definition of individual home-affected axes.

e.g. !home 10 20 will cause a home move only in X+Y,
!home 10 0 20 will cause a home move only in X+Z
!home y 5.5 will add a Y-axis move to home and
!home z 0 will remove the Z-axis from the home move.
!home 0 deletes all home positions.

The positions are stored by the regular save instruction.

Remarks: Used in snapshot modes (**sns**m) 2 and 7.

Response: Position value(s) depending on dim and number of axes

Examples:

!home y 10.2 Set home position Y-value to 10.2 (e.g. [mm] when dim=2)

!home 10 0 20 Set home position X,Y,Z

?home x Read currently used home position of X axis only

?home Read currently used home positions of all axes

27.20. snssave (Save Snapshot Array)

Syntax: !snssave, snssave or ?snssave
Parameter: none or 0 or -1...-15I 1...15
Availability: 2nd generation TANGOs (e.g. Desktop HE) from Firmware 1.77.

Description: The snssave instruction permanently stores the snapshot array positions (set by !snsa or !snsp) in the TANGO controller. The Snapshot array (snsa, snsc) is restored after power-on or reset, which is useful for standalone applications without PC.

Executing a snssave command always returns the "OK... " string when writing to the internal memory successfully completed.

The default way is using snssave without a parameter.

Bitmasks can be used with the snssave instruction to include or exclude random axes from being saved:

1... 15 the masked axes 1,2,4,8 will be saved if available.
-1...-15 the masked axes -1,-2,-4,-8 will be saved if available or not (forced)

The "available axes" are the ones that are set by the !snsa or !snsp instruction (e.g. !snsa x 150.2, !snsa z 3.3 → X+Z or by !snsa 1 10 15 3 → X,Y,Z, etc.) so only those axes will travel in snapshot modes like e.g. snsm 1, 2 or 7.

"snssave 0" deletes a saved snapshot array from non-volatile memory, so it will not be loaded from the next power-on or reset (but does not remove it from the current snsa + snsc, therefore use !snsa 0 to delete the array).

Reading ?snssave returns informations about the saved snapshot array. It returns two parameters: the number of saved lines (snsc) and the saved axes as a decimal number representing the sum of axis bits (1=X,2=Y,4=Z,8=A).

Remarks: Best practice is to send a save instruction only when all axes are idle. At least for controllers with 4 axes, snssave should not be executed while the 4th axis is traveling. And for a TANGO 3 mini, a save instruction should not be executed while any axis is traveling in closed loop.

Response: ASCII string "OK... ", "ERR" with error number or the number of lines and the used axes if requested by '?'

Example: !snssave => OK... (Snapshot array successfully saved)
snssave => OK... (same as !snssave)
snssave 0 => OK... (Snapshot array successfully deleted)
?snssave => 238 7 (saved array has 238 lines for X,Y,Z)

27.21. dissect (Direct Dissection Start)

Syntax: !dissect, dissect or ?dissect
Parameter: none, 1 or 2

Availability: 2nd generation TANGOs (e.g. Desktop HE) from Firmware 1.78.

Description: Similar to snapshot mode (**sns**) 3, this instruction starts a dissection (continuous path) sequence along the position values of the snapshot array (sna). The path velocity is set by **scanvel**.

Dissect offers a direct, easy way for executing the continuous path, without the need of setting any modes or events and without blocking the communication.

When called without a parameter, the sequence is executed once
Called with 1, the axes move to the first array position entry
Called with 2, the position array executes/repeats endlessly

The running state can be checked any time by "?dissect".
If idle it returns 0, else it returns the current array entry (index) number that is processed (range 1 to 1024).
In case there is no position data in the snapshot array, "?dissect" returns -1.

A running dissect can be aborted by the abort instruction "a".

Remarks: The snapshot array must contain position values.
A slight position deviation will build up and so the final position will not be reached precisely (nm to μ m deviation).
This must be considered when continuing from there or when an endless sequence is started. Then, the slight deviation will continue to build up and cause a slight, continuous drift.

Response: When active: The currently executed index 1...N
When idle : 0
When no position data available: -1

Examples:
!dissect Starts a continuous path once through the snapshot array
!dissect 1 Only executes a move to the 1st snapshot array position (start)
!dissect 2 Starts an endless repetition of the continuous path
?dissect ==> 0 Read the state of the dissect (here: 0 = idle or finished)
?dissect ==> -1 Read the state of the dissect (here: -1 = no position data)
?dissect ==> 17 Read the state of the dissect (here: 17 = running at index 17)
dissect Same as !dissect
a The abort instruction can be used to stop a running dissect

28. Nikon FL-Turret Instructions

The Nikon FL-Turret Wheel functionality must be configured by '**configturret**'. If the FL-Turret is powered from the TANGO, '**configvbus 1**' must also be set.

TANGO Desktop-E, HE and 3 mini support the Nikon FL-Turret from Firmware 1.74. The Nikon Turret must be connected to the TANGO RS232 port through a special interface controller, provided by Märzhäuser. The instructions are identical to the turret interface controller commands, the TANGO only acts as interface.

Before using the turret, the '**?tur**' instruction should be used to check if the Nikon FL-Turret is configured and connected. Else, no communication is possible.

28.1. tur (FL-Turret: Read Connection State)

Syntax: ?tur
Parameter: none

Availability: All TANGO types from Firmware 1.74 **

Description: Read the connection state of the Nikon FL-Turret.

Remarks: If 'tur' does not return a 1, the other FL-Turret instructions should not be used (would time-out without a response). In such case, if the FL-Turret is connected, please check if the turret is configured: '**?configturret**' must be 1.

** TANGO controllers which do not support the turret reply a 0.

Response: 1 = connected
 0 = turret not connected or not configured in the TANGO
 Timeout = no turret adapter connected or no power

Examples: ?tur => 1 (FL-Turret is present)

28.2. init (FL-Turret: Initialize the Turret)

Syntax: !init or ?init
Parameter: 1, 2, 3 or none

Availability: TANGO Desktop-E, TANGO 3 mini, and 2nd generation TANGOs from Firmware 1.74 with available RS232 port.

Description: Initialize the FL-Turret.
Typically, the instruction is sent without a parameter, which initializes the turret entirely (filter and shutter). It is also possible to initialize the components individually:

Parameter	Function
None	Fully initialize the turret (filterwheel + shutter)
0	Fully initialize the turret =same as without param.
1	Only initialize the filter wheel part
2	Only initialize the shutter part

Response: Initialization state 0 (not initialized) 1, 2, or 3 (fully)

Examples:
?init => 0 Read the initialization state (here: not initialized)
!init Fully initialize the FL-Turret with shutter
?init => 3 Read the initialization state (here: fully initialized)

28.3. fil (FL-Turret: Select Filter)

Syntax: !fil or ?fil
Parameter: 1, 2, 3, ...6, or + or -

Availability: TANGO Desktop-E, TANGO 3 mini, and 2nd generation TANGOs from Firmware 1.74 with available RS232 port.

Description: Select a filter. The filter wheel will revolve to the specified filter position.

Remarks: From FL-Turret firmware 1.02 it is also possible to change the filter positions to the previous (-) or next (+) filter.

Response: Current filter position 1...6, or
 -1 when not initialized,
 0 when not at position (e.g. still revolving)

Examples: !fil 3 Go to filter number 3
 ?fil => 3 Filter number 3 is currently selected
 !fil + Go to next filter
 ?fil => 4 Filter number 4 is currently selected
 !fil - Go to previous filter

28.4. shut (FL-Turret: Open/Close the Shutter)

Syntax: !shut or ?shut
Parameter: 0 or 1

Availability: TANGO Desktop-E, TANGO 3 mini, and 2nd generation TANGOs from Firmware 1.74 with available RS232 port.

Description: Open (1) or close (0) the shutter of the FL-Turret.

Response: Current state of the shutter
 0 when opened
 1 when closed
 -1 when not initialized

Examples: !shut 0 Open the shutter
 ?shut => 0 The shutter is open

28.5. er (FL-Turret: Read Turret Error State)

Syntax: ?er or !er 0
Parameter: none (or 0)

Availability: TANGO Desktop-E, TANGO 3 mini, and 2nd generation TANGOs from Firmware 1.74 with available RS232 port.

Description: Read or clear the error state of the Nikon FL-Turret.

Response: Leading ASCII 'E' with error number as integer, "E0" = ok

Examples: ?er => E0 There is no error
 !er 0 Clear the error state to zero

28.6. env (FL-Turret: Enable/Disable 5V)

Syntax: !env or ?env
Parameter: 0 or 1

Availability: TANGO Desktop-E, TANGO 3 mini, and 2nd generation TANGOs from Firmware 1.74 with available RS232 port.

Description: Enable (1) or disable (0) the 5V of the FL-Turret. The default is disabled (0).

Response: Current state of the 5V (0 or 1)

Examples: !env 1 Enable the 5V
 ?env => 1 The 5V are enabled

28.7. empower (FL-Turret: Enable/Disable 24V)

Syntax: !empower or ?empower
Parameter: 0 or 1

Availability: TANGO Desktop-E, TANGO 3 mini, and 2nd generation TANGOs from Firmware 1.74 with available RS232 port.

Description: Enable (1) or disable (0) the 24V of the FL-Turret. The default is enabled (1).

Remarks: Empower is handled by the Nikon Turret Controller automatically. So the empower instruction is only required to manually disable the 24V power to the Turret. Or to read the power state.

Response: Current state of the 24V (0 or 1)

Examples: !empower 1 Enable the 24V
 ?empower => 1 The 24V are enabled

28.8. auto (FL-Turret: Auto Response)

Syntax: !auto or ?auto
Parameter: 0 or 1

Availability: TANGO Desktop-E, TANGO 3 mini, and 2nd generation TANGOs from Firmware 1.74 with available RS232 port.

Description: Set or read the auto response mode of the FL-Turret.
 0 = Auto response is off (default)
 1 = Auto response is on

Response: 0 or 1

Examples: !auto 0 Turn auto response off
 ?auto => 0 Auto response is off

28.9. cmode (FL-Turret: Continuous Mode)

Syntax: !cmode or ?cmode
Parameter: 0 or 1

Availability: TANGO Desktop-E, TANGO 3 mini, and 2nd generation TANGOs from Firmware 1.74 with available RS232 port.

Description: Set or read the continuous mode of the FL-Turret.
0 = Continuous mode is off
1 = Continuous mode is on

Response: 0 or 1

Examples: !cmode 0 Turn continuous mode off
?cmode => 0 Continuous mode is off

28.10. res (FL-Turret: Software Reset)

Syntax: !res
Parameter: none

Availability: TANGO Desktop-E, TANGO 3 mini, and 2nd generation TANGOs from Firmware 1.74 with available RS232 port.

Description: Reset the FL-Turret and Turret Controller.
The Turret Controller will not be available for ~200ms.

Response: none

Examples: !res Force a Software Reset of the FL-Turret

28.11. nfltctrver (FL-Turret: Firmware Version)

Syntax: ?nfltctrver
Parameter: none

Availability: TANGO Desktop-E, TANGO 3 mini, and 2nd generation TANGOs from Firmware 1.78 with available RS232 port.

Description: Read the FL-Turret Controller firmware version.

Remarks: Available from FL-Turret firmware 1.02

Response: Firmware Version string, usually a floatingpoint number with two decimal places.

Examples: ?nfltctrver => 1.02

29. Filter Wheel Instructions

From Firmware 1.74, TANGO Desktop-E, 3 mini and 2nd generation TANGOs support controlling of a Märzhäuser Filter Wheel on a motor and encoder axis (**faxis**). After initializing with `finit` instead of `cal`, the axis is excluded from moves, `cal` etc. instructions and operates with the here described instructions only.

29.1. `faxis` (Axis for Filter Wheel)

Syntax: `!faxis` or `?faxis`

Parameter: `x, y, z, a, or 0`

Availability: TANGO DT-E, 3 mini, 2nd generation TANGOs from Firmware 1.76

Description: Read or set the axis where the Märzhäuser Filter Wheel is connected to. The filter instructions will access this axis. Default = 0 (disabled/not configured yet).

Response: Axis of the Märzhäuser Filter Wheel `x,y,z,a, or 0` = disabled

Examples: `?faxis => y` (The filter wheel is controlled through Y axis)
`!faxis a` (Set to A)

29.2. `finit` (Initialize the Filter Wheel)

Syntax: `!finit, finit` or `?finit`

Parameter: `none`

Availability: TANGO DT-E, 3 mini, 2nd generation TANGOs from Firmware 1.74

Description: Initialize the filter wheel. The wheel must be initialized before selecting a filter by the filter instruction. The response is the same as a `cal` instruction on the filter axis. The initialization state can be read.

Remarks: `finit` disables the HDI (joystick) of the filter wheel axis, so no accidental deviation can occur while using the filter. It also blocks `moa, mor, m` and `cal` instructions on the axis. For a factory teach-in of the filter positions (**posshift**), the HDI must be re-enabled by `!joydir [faxis] 2` or use `cal`.

Remarks: `finit` will move to the first filter position (of `posshift`).
2nd generation TANGOs from Firmware 1.78 and higher will also apply an individual position correction of filter 1 from ETS. Firmware of 1st gen. TANGOs and Firmware before 1.78 does not apply the individual filter 1 correction value from the ETS. Therefore, the axis must be positioned to filter 1 by the **"filter 1"** instruction after `finit` has finished.

Response: Initialization state (1=initialized, 0=not initialized)

Examples: `finit` (Initialize the filter wheel → e.g. "@A@-.")
`?finit => 1` (The filter wheel is initialized)

`finit => "@@@A."`
`filter 1` (in order to apply individual correction)

29.3. fcount (Read Number of Filter Wheel Positions)

Syntax: ?fcount or fcount
Parameter: none

Availability: TANGO DT-E, 3 mini, 2nd generation TANGOs from Firmware 1.74

Description: Read the number of filter positions of the filter wheel.

Response: Number of available filter positions (0 when faxis = 0).

Examples: fcount => 6 (The filter wheel has 6 positions)

29.4. filter (Select Filter)

Syntax: !filter, filter or ?filter
Parameter: 1, 2, ...[fcount] or +, -

Availability: TANGO DT-E, 3 mini, 2nd generation TANGOs from Firmware 1.74

Description: Select a filter. The filter wheel revolves to the desired filter position. Either directly select the filter position or browse forward (+) or backward (-) through the positions. The current filter position and state can be read by ?filter.

Remarks: In case of a filter number, do not use a sign (+/-), a sign is always interpreted as a filter+ / filter- instruction.

From Firmware 1.79, the 2nd generation TANGOs provide traveling "over 0" when going from the first<->last position. The previous TANGO generation or Firmware before 1.78 there will travel the whole range forward or backward, even at +/-.

Response: The filter move will reply like a move instruction. And when requested by '?', the Currently selected filter 1 ... [fcount], -1 if not initialized, 0 while traveling.

Examples: ?filter => -1 (Filter wheel not initialized, needs "finit")
 !filter 2 (Select filter 2)
 filter 2 (Same as !filter 2)
 ?filter => 0 (The filter wheel is traveling)
 ?filter => 2 (Filter 2 is selected)
 filter + (One filter forward)
 filter - (One filter backward)

30. Objective Revolver Instructions (option)

From Firmware 1.74, TANGO Desktop-E, 3 mini and 2nd generation TANGOs support Märzhäuser Objective Revolver on a motor and encoder axis (configured **raxis**). After initializing with rinit instead of cal, the axis is excluded from moves, cal etc. instructions and operates with the here described instructions only.

30.1. raxis (Axis for Märzhäuser Objective Revolver)

Syntax: !raxis or ?raxis
Parameter: x, y, z, a, or 0

Availability: TANGO DT-E, 3 mini, 2nd generation TANGOs from Firmware 1.76

Description: Read or set the axis where the Märzhäuser Objective Revolver is connected to. The revolver instructions will access this axis. Default = 0 (disabled/not configured yet).

Response: Axis of the Märzhäuser Objective Revolver x,y,z,a,0=disabled.

Examples: ?raxis => y (The revolver is controlled through Y axis)
!raxis a (Set to A axis)

30.2. rinit (Initialize the Objective Revolver)

Syntax: !rinit, rinit or ?rinit
Parameter: none

Availability: TANGO DT-E, 3 mini, 2nd generation TANGOs from Firmware 1.74

Description: Initialize the objective revolver. The revolver must be initialized before selecting an objective by the obj instruction. The response is the same as a cal instruction on the revolver axis. The initialization state can be read.

Remarks: rinit disables the HDI (joystick) of the revolver axis, so no accidental deviation can occur while using the revolver. It also blocks moa, mor, m and cal instructions on the axis. For a factory teach-in of the objective positions (**posshift**), the HDI must be re-enabled by "!joydir [raxis] 2" or use cal.

Remarks: rinit will move to the first objective position (of posshift). 2nd generation TANGOs from Firmware 1.78 and higher will also apply an individual position correction of obj 1 from the ETS. Firmware of 1st gen. TANGOs and Firmware before 1.78 does not apply the individual obj 1 correction value from the ETS. Therefore, the axis must be positioned to obj 1 by the "**obj 1**" instruction after rinit has finished.

Response: Initialization state (1=initialized, 0=not initialized)

Examples: rinit (Initialize the revolver → e.g. "A@@-.")
?rinit => 1 (The revolver is initialized)

30.3. rcount (Read Number of Revolver Wheel Positions)

Syntax: ?rcount or rcount
Parameter: none

Availability: TANGO DT-E, 3 mini, 2nd generation TANGOs from Firmware 1.74

Description: Read the number of objective positions of the revolver.

Response: Number of available objective positions (0 when raxis = 0).

Examples: rcount => 3 (The revolver has 3 positions)

30.4. obj (Select Objective)

Syntax: !obj, obj or ?obj
Parameter: 1, 2, ...[rcount] or +, -

Availability: TANGO DT-E, 3 mini, 2nd generation TANGOs from Firmware 1.74

Description: Select an objective of the objective revolver. Either select the objective by its number or browse forward/backward (+/-) through the positions. The current objective position and state can be read by ?obj.

Remarks: In case of an objective number, do not use a sign (+/-), a sign is always interpreted as an obj+/obj- instruction.

As of Firmware 1.78, the revolver does not travel "over 0". When going from the first<->last position, the revolver will travel the whole range forward or backward, even at +/-.

Response: Currently selected objective 1 ... [rcount],
-1 if not initialized, 0 while traveling.

Examples: ?obj => -1 (The revolver is not initialized, needs "rinit")
!obj 2 (Select objective 2)
obj 2 (Same as !obj 2)
?obj => 0 (The revolver is traveling)
?obj => 2 (Objective 2 is selected)
obj + (One objective forward)
obj - (One objective backward)

31. External MW Filter Wheel Instructions

The Filter Wheel is also available in an "external" version, where it is connected to the TANGO via RS232 instead of using/occupying a TANGO axis. Then, the external Wheel functionality must be configured by '**configturret**'. If the Wheel is powered from the TANGO, 'configvbus 1' must also be set.

TANGO Desktop-E, HE and 3 mini support the external Wheel from Firmware 1.74. The Filter Wheel must be connected to the TANGO RS232 port. The instructions are slightly different to the Filter Wheel instructions but with the same functionality, so using the both, one or the other Filter Wheel have the same parameters and replies, only the command names differ.

Before using the Wheel, the '**?tur**' instruction should be used to check if the Filter Wheel is configured and connected. Else, no communication is possible.

Comparison of Filter Wheel instructions:

Filter on axis		Filter via RS232	Function
N/A	↔	configturret	Configure the external wheel connection
N/A	↔	tur	Check if the external Wheel is present & on
finit	↔	init	Initialize the filter wheel
filter	↔	fil	Select a wheel or request currently selected
autostatus	↔	auto	Reply after move or init ended yes/no
err	↔	er	Error state read/clear
pa [faxis]	↔	enpower	Motor amplifier on/off/state
reset	↔	res	Controller reset
version 1	↔	nfltctrver	Firmware version number without text
etswposcorr	↔	filcorr	individual filter position correction
save	↔	filsave	save filcorr in external wheel TANGO

31.1. tur (Read Connection State)

Syntax: ?tur
 Parameter: none

Availability: All TANGO types from Firmware 1.74 **

Description: Read the connection state of the Filter Wheel.

Remarks: If 'tur' does not return a 1, the other Wheel instructions should not be used (would time-out without a response). In such case, if the Wheel is connected, please check if the Wheel "turret" is configured: '**?configturret**' must be 1.
 ** TANGO controllers which do not support the Wheel reply a 0.

Response: 1 = connected
 0 = Wheel not configured in the TANGO (configturret=0)
 Timeout = no cable connected or no power

Examples: ?tur => 1 (External Filter Wheel is present)

31.2. init (Initialize the Filter Wheel)

Syntax: !init, init or ?init
Parameter: none

Availability: TANGO Desktop-E, TANGO 3 mini, and 2nd generation TANGOs from Firmware 1.74 with available RS232 port.

Description: Same as "**finit**", but for the RS232 connected Filter Wheel. Initialize the Filter Wheel.

Remarks: init will move to the first filter position (of posshift).

2nd generation TANGOs from Firmware 1.78 and higher will also apply an individual "**filcorr 1**" correction of filter 1.

Firmware of 1st gen. TANGOs and Firmware before 1.78 does not apply the individual "filcorr 1" correction value. Therefore, the axis must be positioned to filter 1 by the "**fil 1**" instruction after init has finished.

Response: Initialization state 0 (not initialized), 1 (initialized)

Examples: init (Initialize the filter wheel → e.g. "A@--.")
 ?init => 1 (The filter wheel is initialized)

31.3. fil (Select Filter)

Syntax: !fil, fil or ?fil
Parameter: 1, 2, 3, ...6, or + or -

Availability: TANGO Desktop-E, TANGO 3 mini, and 2nd generation TANGOs from Firmware 1.74 with available RS232 port.

Description: Same as "**filter**", but for the RS232 connected Filter Wheel. Select a filter. The filter wheel will revolve to the specified filter position or to next/previous by +/-, including travel "over zero" (1→6 / 6→1).

Remarks: Filter wheels might have more or less filter positions than 6, e.g. 3, 4 or 8 etc. depending on hardware → Filter 1...N.

Response: Current filter position 1...6, or
 -1 when not initialized,
 0 when not at position (e.g. still revolving)

Examples: !fil 3 Go to filter number 3
 ?fil => 3 Filter number 3 is currently selected
 !fil + Go to next filter
 ?fil => 4 Filter number 4 is currently selected
 !fil - Go to previous filter
 fil - Same as !fil -

31.4. shut (Open/Close the Shutter)

Syntax: !shut or ?shut
Parameter: 0 or 1
Description: Dummy instruction, not used
Response: Always -1 (not initialized)

31.5. `er` (Read Error State)

Syntax: `?er` or `!er 0`
Parameter: none (or 0)

Availability: TANGO Desktop-E, TANGO 3 mini, and 2nd generation TANGOs from Firmware 1.74 with available RS232 port.

Description: Same as "**err**", but for the RS232 connected Filter Wheel. Read or clear the error state of the Filter Wheel.

Response: TANGO error number as integer, 0 = ok

Examples: `?er => 0` There is no error
`!er 0` Clear the error state to zero

31.6. `env` (Enable/Disable 5V)

Syntax: `!env` or `?env`
Parameter: 0 or 1
Description: Dummy instruction, not used
Response: Always 1 (The 5V are enabled)

31.7. `enpower` (Enable/Disable Motor Power)

Syntax: `!enpower` or `?enpower`
Parameter: 0 or 1

Availability: TANGO Desktop-E, TANGO 3 mini, and 2nd generation TANGOs from Firmware 1.74 with available RS232 port.

Description: Same as "**pa** [faxis]", but for the connected Filter Wheel. Enable (1) or disable (0) the Filter Wheel power amplifier.

Remarks: Allows switching off the motor power.

Response: Current state of the wheel's motor amplifier (0 or 1)

Examples: `!enpower 1` motor power on (default)
`?enpower => 1` motor power is on

31.8. `auto` (Auto Response)

Syntax: `!auto` or `?auto`
Parameter: 0 or 1

Availability: TANGO Desktop-E, TANGO 3 mini, and 2nd generation TANGOs from Firmware 1.74 with available RS232 port.

Description: Same as "**autostatus**", but for the connected Filter Wheel. Set or read the auto response mode of the Filter Wheel.
1 = Auto response is on (default, → A@--. / @@--. reply)
0 = Auto response is off

Response: 0 or 1

Examples: `!auto 0` Turn auto response off
`?auto => 0` Auto response is off

31.9. cmode (Continuous Mode)

Syntax: !cmode or ?cmode
Parameter: 0 or 1
Description: Dummy instruction, not used
Response: Always 0 (cmode off)

31.10. res (Software Reset)

Syntax: !res or res
Parameter: none

Availability: TANGO Desktop-E, TANGO 3 mini, and 2nd generation TANGOs
 from Firmware 1.74 with available RS232 port.

Description: Reset the Filter Wheel and its controller.
 The Controller will not be available for ~1.5 seconds.

Remarks: Also works as an emergency stop for the external Filter Wheel

Response: none

Examples: !res Force a Software Reset of the Filter Wheel

31.11. nfltctrver (Firmware Version)

Syntax: ?nfltctrver or nfltctrver
Parameter: none

Availability: TANGO Desktop-E, TANGO 3 mini, and 2nd generation TANGOs
 from Firmware 1.78 with available RS232 port.

Description: Read the external Filter Wheel Controller firmware version.

Response: Firmware Version string, usually a floatingpoint number
 with two decimal places.

Examples: ?nfltctrver => 1.79

31.12. filcorr (Filter Position Correction of external wheel)

Syntax: !filcorr, filcorr or ?filcorr
Parameter: 1, 2,...8 and -0.4 ... +0.4

Availability: 2nd generation TANGOs from Firmware 1.80

Description: Individual filter position correction of the RS232 connected Filter Wheel.

Each filter position can be corrected (up to 8 positions).

The correction range is ± 0.4 "filter positions" and the resolution is 0.000001, 10E-6 positions. **

The correction values can be set by filter index and correction value.

The values can be read by index or all (8) at once.

It is possible to reset all correction values to 0 at once.

The filcorr correction is applied immediately, but the filter position must be moved to again in order to apply the correction (it is not applied while the axis is standing at the position, only from the next move).

**:
1 corresponds to one filter position, e.g. $360^\circ/6 = 60^\circ$. Therefore, the smallest corr step would be $60^\circ \cdot 0.000001$.

Remarks: Filter wheels might have more or less filter positions than 6, e.g. 3, 4 or 8 etc. depending on hardware → Filter 1...N.

Response: Current filter position correction value(s) as floatingpoint number(s) with 6 decimal places. Either one or all 8 in the wheel available values are returned (even if the wheel has less filters).

Examples: !filcorr 0 (reset all filcor correction values to 0)
!filcorr 1 0 (reset the correction value for filter 1)
!filcorr 1 -0.0042 (apply a correction to filter 1 position)
!filcorr 3 0.01 (apply a correction to filter 3 position)
?filcorr 3 ==> 0.010000 (read correction of filter 3)
?filcorr ==> -0.004200 0.000000 0.010000 0.000000 0.000000
0.000000 0.000000 (returns 8 filcorr values)

Example Sequence:

```
init          the filter wheel must be initialized
fil 3        move to the filter that has to be corrected

!filcorr 3 -0.005  apply a correction to the filter position
fil 3        execute a new, now corrected move to the same position

...          if required, modify the !filcorr value again
            and repeat filcorr, fil 3

filsave ==> OK...  if the filter is or all filters are corrected,
            save the filcorr values to the external wheel.
```



31.13. **filsave (Save Filter Position Correction to Wheel)**

Syntax: `!filsave, filsave or ?filsave`

Parameter: `none`

Availability: `2nd generation TANGOs from Firmware 1.80`

Description: `Save (store) the filcorr values permanently to the RS232 connected external filter wheel.`

`Behaves like a 'save' instruction but is executed on the external wheel (the TANGO in the wheel).`

Response: `ASCII string "OK...", or "ERR" with error number`

Example: `filsave => OK... (The parameters were stored successfully)`

32. Piezo-Z Controller Instructions

The Piezo-Z controller option must be configured by '**configwsz**'.

TANGO Desktop-E, HE and 3 mini support a Piezo-Z controller from Firmware 1.73. The Piezo-Z controller must be connected to the TANGO RS232 port through a RS232 null modem cable (same as the default TANGO RS232 cable).

The piezo Z move instructions are blocking commands (except the pzpos request), which means the communication to the TANGO will not be possible until the piezo axis has reached its target. As the commands (except pzpos) do not generate an automatic reply, a 'err' request can be sent directly after the pz command and so the reply of the 'err' request signals the end of the move. As a benefit it also reports a possible error.

The error states from a piezo instruction can include special error numbers:

Error 73 = move error (possibly a positioning error)
Error 140 = connect error (Piezo-Z controller not configured by **configwsz**)
Error 141 = timeout error (no response from the Piezo-Z controller)
Error 142 = address error (error in the returned message from the controller)

32.1. pzcal (Piezo-Z Calibrate)

Syntax: !pzcal or pzcal
Parameter: none

Availability: TANGO Desktop-E, Desktop HE, 3 mini, from Firmware 1.73

Description: Initialize the piezo-Z stage.
The axis travels towards its lower position and sets the axis origin (pos 0).

Remarks: Blocking instruction. No communication possible until the function ends. It is recommended to send an err request after the instruction and wait until it returns the error number, e.g. 0.

Before Firmware 1.76, the cal instruction was non-blocking.

Response: none

Examples: pzcal
err => 0

32.2. pzrm (Piezo-Z Range Measure)

Syntax: !pzrm or pzrm
Parameter: none

Availability: TANGO Desktop-E, Desktop HE, 3 mini, from Firmware 1.73

Description: Range Measure the piezo-Z stage.
The axis travels towards its upper position and sets the axis upper limit there (max. pos).

Remarks: Blocking instruction. No communication possible until the function ends. It is recommended to send an err request after the instruction and wait until it returns the error number, e.g. 0.

Before Firmware 1.76, the rm instruction was non-blocking.

Response: none

Examples: pzrm
err => 0

32.3. pzmoa (Piezo-Z Move Absolute)

Syntax: !pzmoa or pzmoa
Parameter: none

Availability: TANGO Desktop-E, Desktop HE, 3 mini, from Firmware 1.73

Description: Travel to the specified position.
The position is set as full nanometers [nm].

Remarks: Blocking instruction. No communication possible until the function ends. It is recommended to send an err request after the instruction and wait until it returns the error number, e.g. 0.

Response: none

Examples: pzmoa 15000 (move to 15µm)
err => 0

32.4. pzmor (Piezo-Z Move Relative)

Syntax: !pzmor or pzmor
Parameter: none

Availability: TANGO Desktop-E, Desktop HE, 3 mini, from Firmware 1.73

Description: Travel a specified distance.
The distance is set as full nanometers [nm].

Remarks: Blocking instruction. No communication possible until the function ends. It is recommended to send an err request after the instruction and wait until it returns the error number, e.g. 0.

Response: none

Examples: pzmor -5000 (travel 5µm back from the current position)
err => 0

32.5. pzpos (Piezo-Z Position)

Syntax: ?pzpos or pzpos
Parameter: none

Availability: TANGO Desktop-E, Desktop HE, 3 mini, from Firmware 1.73

Description: Read out the current position.
The position is returned as full nanometers [nm] and is taken from the measuring system. So there might be a slight deviation between the requested pzmoa position and the read position as well as some noise.

Response: Measuring system position in [nm]

Examples: pzpos => 14998 (current Z position in nm)

33. Piezo-XY Stage Controller Instructions

The Piezo-XY controller requires a special piezo firmware and interface.

A special (24V) version of the TANGO Desktop HE can control a piezo XY stage. It can be used like any other TANGO controller with its instruction set. One instruction is added to read the piezo controller's error state:

33.1. perr (Piezo Error)

Syntax: ?perr or perr, !perr

Parameter: none, -1...-5 or error number 0...32767

Availability: TANGO Desktop HE XY-piezo version from Firmware 1.77

Description: Read the error of the piezo controller. similar to the TANGO 'help' function, it returns an describing text about the momentary error state or about a specified error number.

It contains the error state with appended error description. By reading perr, the error state is not changed or cleared to zero.

The piezo error state can be cleared by sending '!perr', the error and entire error history by '!perr 0'.

Called without a parameter:

It returns the controller's error state with description

Called with a parameter (error numbers 0 to 32767):

It returns this error with its corresponding description

Called with a negative parameter (-1...-5):

It returns several states or a piezo error history.

-1 : returns the last 16 errors (L->R, left is the newest)
-2 : number of occurred instruction errors
-3 : number of occurred transmission errors (communication)
-4 : number of piezo connect attempts
-5 : state of the connection (1=connected, 0=not, -1=blocked)

Remarks: Perr does not apply to the Piezo-Z controller-

Response: Error number as decimal value, error description as ASCII text or integer number(s) depending on the used parameter (-1...-5)

Example:

```
perr => PERR 0, No error (current error state & description)
perr 1 => PERR 17, Parameter out of range (description for error 1)
perr -1 => 17 0 0 0 0 0 0 0 0 0 0 0 0 0 0 0 (error history L->R, left=newest)
perr -2 => 1 (one instruction-related error)
perr -3 => 0 (no piezo communication errors)
perr -4 => 1 (one connection attempt executed)
perr -5 => 1 (xy piezo controller is connected)
!perr (clear the current error state)
!perr 0 (clear error and error history)
```



34. Appendix A – anain options of different TANGOs

Ch.	Signal Name/Controller	Desktop HE	PCI-E/DT-E	PCI-S/DT-S	PCIE21	3mini, 22
0	HDI IN1A (Joystick X)	-	X	X	-	-
1	HDI IN2A (Joystick Y)	-	X	X	-	-
2	HDI IN3A (Joystick Z)	-	X	X	-	-
3	HDI IN4A (Joystick A)	-	X	X	-	-
4	HDI Speedpoti	-	X	X	-	-
5	HDI IN1B	-	X	X	-	-
6	HDI IN2B	-	X	X	-	-
7	HDI IN3B	-	X	X	-	-
8	HDI IN4B	-	X	X	-	-
9	HDI-ID	-	X	X	-	-
10	AUX I/O ANINO	X	X	X	X	-
11	U-HIP PSE	X	X	X	X	(X)
12	V-MOT	X	X	X	X	(X)
13	X-ID0	-	X	X	-	-
14	X-ID1 / PCI-S: Temp.	-	X	X	-	-
15	REF (2.5V =512 digit)	(X)	X	X	(X)	(X)
16	5VEXT1 HDI	X	X	-	X	(X)
17	AUX I/O PSE ON 1/0	X	-	-	X	X
18	5V USB (from PC) 1/0	X	-	-	(X)	X
19	Powersupply Good 1/0	(ok 1/0)	-	-	X	X
20	5V Encoder ok 1/0	(ok 1/0)	-	-	X	X
21	5V external 1 (V)	(ok 1/0)	-	-	(ok 1/0)	(ok 1/0)
22	5V external 2 (V)	(ok 1/0)	-	-	(ok 1/0)	(ok 1/0)
23	5V HDI (V)	X	-	-	X	X
24	Brake Voltage (V)	X	-	-	X	X
25	V-BUS 24V (V)	I CAN (A)	-	-	I CAN (A)	X
26	VCC5 (V)	X	-	-	X	X
27	U-PSE (V)	X	-	-	X	X
28	V-MOT (Supply) (V)	X	X	-	X	X
29	Input current (A)	X	-	-	X	X
30	Input power (W)	X	-	-	X	X
31	Input I-peak (A)	X	-	-	X	X
32	Coax Drive Sin Cos X	X	X	X	X	X
33	Coax Drive Sin Cos Y	X	X	X	X	X
34	Coax Offs. Sin Cos X	-	X	X	-	-
35	Coax Offs. Sin Cos Y	-	X	X	-	-
36	Coax Fact. Sin Cos X	-	X	X	-	-
37	Coax Fact. Sin Cos Y	-	X	X	-	-
40	Joystick deflection X	X	X	X	X	X
41	Joystick deflection Y	X	X	X	X	X
42	Joystick deflection Z	X	X	X	X	X
43	Joystick deflection A	X	X	X	X	0
50	I/O Module Supply	X	X	-	(X)	-
51	I/O Module Supply (V)	X	X	-	(X)	-
52	5V INT (V)	X	-	-	X	TM3 22
53	5V USB from PC (V)	X	-	-	(X)	TM3 22
54	5V USB HOST (V)	X	-	-	(X)	-
55	I-CAN24 Peak (A)	X	-	-	X	-
56	Input I-peak since on	X	-	-	X	TM3 22
57	Ext. Powersupply (V)	-	-	-	X	-
58	HDD connector 12V (V)	-	-	-	X	-
59	PCI-E conn. 12V (V)	-	-	-	X	-
60	ANINO (V)	X	-	-	X	-
61	5V external 1 (V)	-	-	-	X	-



Ch.	Signal Name/Controller	TANGO-C Pilot	integrale	integrale 2
0	HDI IN1A (Joystick X)	X	-	-
1	HDI IN2A (Joystick Y)	X	-	-
2	HDI IN3A (Joystick Z)	X	-	-
3	HDI IN4A (Joystick A)	X	-	-
4	HDI Speedpoti	X	-	-
5	HDI IN1B	X	-	-
6	HDI IN2B	X	-	-
7	HDI IN3B	X	-	-
8	HDI IN4B	X	-	-
9	HDI-ID	X	-	-
10	AUX I/O ANINO	X	(EXT 5V)	0
11	U-HIP PSE	X	(HDI AV)	(X)
12	V-MOT	X	(U-HIP)	X
13	X-ID0	X	(VCC3)	(VCC3)
14	X-ID1 / PCI-S: Temp.	X	(V-DSP)	0
15	REF (2.5V =512 digit)	X	(V-ENC)	512
16	5VEXT1 HDI	-	V-MOT	X
17	AUX I/O PSE ON 1/0	-	-	X
18	5V USB (from PC) 1/0	-	-	0
19	Powersupply Good 1/0	-	-	0
20	5V Encoder ok 1/0	-	-	X
21	5V external 1 (V)	-	-	X
22	5V external 2 (V)	-	-	0
23	5V HDI (V)	-	-	X
24	Brake Voltage (V)	-	-	0
25	V-BUS 24V (V)	-	-	0
26	VCC5 (V)	-	-	X
27	U-PSE (V)	-	-	(X)
28	V-MOT (Supply) (V)	X	X	X
29	Input current (A)	-	-	-
30	Input power (W)	-	-	-
31	Input I-peak (A)	-	-	-
32	Coax Drive Sin Cos X	X	X	X
33	Coax Drive Sin Cos Y	X	X	X
34	Coax Offs. Sin Cos X	X	-	-
35	Coax Offs. Sin Cos Y	X	-	-
36	Coax Fact. Sin Cos X	X	-	-
37	Coax Fact. Sin Cos Y	X	-	-
40	Joystick deflection X	X	X	X
41	Joystick deflection Y	X	X	X
42	Joystick deflection Z	0	0	X
43	Joystick deflection A	0	0	X
50	I/O Module Supply	-	-	-
51	I/O Module Supply (V)	-	-	-
52	5V INT (V)	-	-	X
53	5V USB from PC (V)	-	-	-
54	5V USB HOST (V)	-	-	-
55	I-CAN24 Peak (A)	-	-	-
56	Input I-peak since on	-	-	-
57	Ext. Powersupply (V)	-	-	-
58	HDD connector 12V (V)	-	-	-
59	HDD int. fused 12V (V)	-	-	-
60	ANINO (V)	-	-	0
61	5V external 1 (V)	-	-	-



35. Appendix B – TANGO Controller Types (readsn)

Readsn returns the unique TANGO controller serial number.
The 5th character of the serial number contains the type information:

Example: ?readsn => 2112**A**3002 (here: **A** = TANGO Desktop HE, a 2nd gen. TANGO)

Number	Type
0	TANGO PCI-S, TANGO Desktop-S (DT-S), TANGO PCI
1	TANGO PCI-E, TANGO Desktop-E (DT-E)
2	Pilot Stage
3	Custom
4	TANGO mini (2 axis controller based on Pilot Stage hardware)
5	Custom
6	TANGO integrale
7	Custom
8	TANGO 3 mini
9	Custom
----- 2 nd generation TANGO controllers A-Z :	
A	TANGO Desktop HE (2HE + 3HE)
B	TANGO integrale 2
C	TANGO PCIE21
D	TANGO 3 mini 22

36. Appendix C – Setup for Rotary Axes

Aside the typical linear axes, the TANGO controllers also support rotary axes. Different options and configurations are available, some are explained here:

Applications might be

- filter wheels
- nosepieces (objective revolvers)
- multi station rotary tables
- rotating pumps
- etc.

The axes might be driven by the motor directly, by a toothed belt or a gearbox. They can be in open loop or closed loop (rotary encoder on the motor or table).

1. Rotary Axes by the dim setting

The first option would be using the dim unit 3 (degrees) or 4 (revolutions) for the rotary axis. Those units display the position within one motor revolution. Meaning either [0...] 1 revolution or [0...] 360 degrees. The fractional digits here can be increased by the "resolution" instruction (e.g. "!resolution 6"), which increases it from the default 2 (0.00) to 4 (0.0000) digits, corresponding to a $1/10000$ motor revolution or a $1/10000$ degree (0.36").

This is intended to work on a setting of pitch=1, other values not recommended. The degrees unit (dim 3) only converts the 360 into 1 and back, e.g. a !mor 90 in dim 3 would be seen like a !mor 0.25 in dim 4 (as a $\frac{1}{4}$ motor revolution).

The downsides of the dim settings 3 and 4 are that they are related to a motor revolution. This means, when using teeth belts or gears, the transmission must be considered in the entire axis setup. All velocities and accelerations. Plus, when using the degrees unit (dim 3), only the position values (move,pos) are in degrees, the velocity and acceleration values are still in revolutions.

The idea behind the motor revolutions is, that at pitch=1 it corresponds to a 1mm feed. One motor revolution is seen like 1mm on a linear axis. And as the acceleration values are normally in m/s^2 (a $1/1000$ mm/s^2), those values are applied 1000 times "stronger" than the velocities or positions in mm (rev).

Example:

distance	1mm	= 1	motor revolution	= 360 degrees.
velocity	0.1mm/s	= 0.1	motor revolutions/s	(corresponds to 36 degrees/s)
acceleration	0.2m/s ²	= 200	motor revolutions/s ²	(corresponds to 72000 deg./s ²)

When using the SwitchBoard software, it will do the calculation automatically and send the required values to the TANGO. Just enter revolutions or degrees.

The units dim 3 and 4 show the position (?pos) within one motor revolution. But the motor can be sent to a maximum distance of (?maxpos), meaning multiple revolutions that will not be shown by ?pos. It only shows within one revolution.

Rotary Axes in Modulo Modes

Therefore, a **modulomode** can be assigned to the rotary axis. It keeps the axis position within one revolution and offers different behaviors like only in one direction, not over zero or always shortest distance. Some modes might also allow setting limits (lim) to only have a swiveling angle instead of rotation.

Pumps

The modulomode also allows e.g. pumps to rotate endlessly (without stopping at the maximum axis position value after e.g. 2600 revolutions). Here, speed, sp or move instructions can be used for pumping.

2. Rotary Axes by the pitch setting

Many rotary applications have a certain number of equidistant stops around the circumference. Examples are:

- a nosepiece with 4 objectives
- a filter wheel with 8 filters
- a multi station rotary table with 15 stations

Those applications can certainly be realized with the dim 3 setting, but it might be of advantage to use a pitch and gear combination instead:

- The pitch setting corresponds to the number of stops (stations, positions)
- The gear setting is used to adapt to the transmission factor motor->table.

In such case, the usual and familiar dim 9 setting can be used.

Move instructions direct the axis to the positions:

mor 1 =one stop further, mor -2 =two stops back, moa 5 =go to stop number 5 etc. And the position (?pos) then already returns the stop number, e.g. 5.

Also, the velocity and acceleration settings then are more like the linear axes. The velocity will be in stops per second, the acceleration in 1000 stops/s² and reach more familiar values, similar to linear axes of such a pitch setting. The closed loop target window, lockin range etc., will all be in "stops" then.

Many TANGO controllers (e.g. TANGO 3 mini, Desktop HE) offer a setup mask in SwitchBoard (within the ETS settings) to fully configure such a configuration. Then, also the **filter** or **revolver** instructions can be used instead of moves.

3. Closed Loop on Rotary Axes

A rotary encoder can be mounted either on the motor or on the axis (table etc.). As an encoder period (!encperiod) must be entered, this has to be calculated out of the line count and the axis settings. Formula:

$$\text{Encperiod} = [\text{pitch}] / [\text{encoder lines per revolution}]$$

If the encoder is **mounted on the axis**, this is e.g. 1 / 18000 encoder lines in case the pitch is set to 1 (like it is for dim 3 and 4) or 5/18000 for 5 stops of e.g. a filter wheel. This second example shows that the encoder line count does not always fit (it results in 0.0002777778) and it might be better to use another encoder line count, if possible, that results in a number without endless fractional digits: e.g. choosing 4000 counts --> encperiod = 0.00125.

If the encoder is **mounted on the motor**, then the gear transmission factor must be considered. At a factor of 10, the motor makes 10 turns while the axis only makes 1 turn. Meaning it results in a 10 times higher line count and so in a 10 times smaller encoder period setting:

$$\text{Encperiod} = [\text{pitch}] / ([\text{gear}] * [\text{encoder lines per revolution}])$$

4. Calibrating Rotary Axes (cal)

The rotary axes are calibrated by the usual cal instruction and use the usual velocities (vel, sevel and calbspeed, or the calvel settings if extmode = 1).

Axes can also be calibrated on the encoder reference mark. Because most rotary encoders offer a reference mark, the additional components and wiring of a switch are not required. Therefore, the cal (E0) limit switch must be disabled (swact=0) and the encoder reference must be enabled (encref=1). If modulomode 2 or 3 are activated (at least during cal), the axis can be forced to only travel forward or backward during the calibration sequence.

Recommended is using 2nd generation TANGOs such as the Desktop HE and Firmware 1.77 or higher.

37. Appendix D – Macros (Own Instruction Sequences)

Only available with 2nd generation TANGOs (e.g. Desktop HE) from Firmware 1.76.

The 2nd generation of TANGO controllers supports the execution of macros: Custom sequences, setups, standalone applications with user interaction. Up to 8 user-defined macros can be stored in the TANGO and executed by the '!mac' instruction or at power on, when configured by !configmacro. Several macro specific functions are available aside the Instruction Set:

Macro Instructions (for the user/application)

mac	Macro	: Execute a macro, check state, abort, ...
mstart	Macro Start	: Enter macro code (enter editor mode)
#		: Exit the macro editor mode
msave	Macro Save	: Store the edited macro or check infos, labels
merr	Macro Error	: Macro error counter (read, clear)
mhalt	Macro Halt	: Halt (pause) or continue the macro execution
initxy	Init X+Y	: Fixed integrated macro (X+Y cal, rm, moc)

Macro-internal instructions to be used in a macro

_mw	Macro Wait	: Wait for axis/axes end of move
_mwt	Macro Wait Time	: Wait for time (millisecond delay)
_mwk	Macro Wait Key	: Wait for HDI Key to be pressed or all released
_mwi	Macro Wait Input	: Wait for high or low state of a digital input
_mjl	Macro Jump Label	: Define a label for _mjk and _mj
_mjk	Macro Jump Key	: Define a HDI Key (F1...4) to jump at _mjl Label
_mj	Macro Jump	: Endless macro repeat from _mjl Label to _mj Jump
_ml	Macro Loop Label	: Define the loop start for the _mloop instruction
_mloop	Macro Loop	: Execute a loop (endless, certain number or time)
_mexloop	Macro Exit Loop	: Define optional end of loop by HDI key or input
_mexev	Macro Exit Event	: Define optional end of macro by HDI key or input
_mexerr	Macro Exit Error	: Define to exit the macro on error state (err)
_mhaltev	Macro Halt Event	: Define a macro halt/continue by HDI key or input
_mi	Macro Index	: Set, increment or decrement a user index variable
_mip	Macro Ind. Print	: Send the user index variable value to the PC
_mp	Macro Print	: Allow sending of command replies to the PC
_mreply	Macro Reply	: Send the @@@@. Reply (e.g., initxy does this)
_msend	Macro Send	: Send a text to the application/PC (all lower case)
_mrm	Macro Reply Mode	: Optional message at the start or end of the macro
_mrmt	Macro Reply Text	: Customize optional message at the end of the macro
_mec	Macro SendExeCnt	: Send the number of macro cycles to the application
_mlc	Macro SendLpCnt	: Send the number of mloop cycles to the application

Macro configuration for automatic macro start at power-on

configmacro : Configure a macro (1...8) to be executed at power on

Macro space

Typically, there are 8 macro spaces to store different macros. The 8 spaces are of different size, some for small macros and some for medium or larger size. Size of Macro 1...8: 8192, 1024, 1024, 1024, 256, 256, 256, 256 ASCII characters. ?msave -2 can be used to get an overview of the saved macros, shows their labels.

The detailed description of the macro functionality, the macro instructions and examples can be found in a separate document, the macro functions documentation.

37.1. initxy (Initialize X and Y axis)

Syntax: !initxy or initxy

Parameter: none or 1

Availability: 2nd generation TANGOs (e.g. Desktop HE) from Firmware 1.76.

Description: Covers the initialization routine of a microscope stage (X+Y). It calibrates and range measures both axes, then travels to their center positions and sends a reply when finished. Two versions are available:

a) When called without parameter
cal is executed on X axis first, then on the Y axis.
rm also. Only the final move center is on both axes
simultaneously (cal x, cal y, rm x, rm y, moc 3).

b) When called with parameter 1
The fast option - cal and the following rm are both
executed on X+Y simultaneously, which saves time.
As a), move center is executed simultaneously also.

Remarks: As initxy is a macro function itself, it can not be called from within a macro code or when another macro is running. Due to the execution of cal and rm axis after axis, the time for executing initxy could exceed usual timeouts, which must be considered e.g. when used with the TANGO DLL. Initxy should also not be combined with cal or move instructions on other axes, as the replies might interfere.

Response: "@@@@." Reply like a move instruction, not A or D like cal/rm.

Examples: initxy → @@@-. (init complete reply of a 3-axis TANGO)
Initxy 1 → @@@-. (init sequence successfully completed)
Initxy 1 → EEE-. (init sequence not correctly completed)

Macro code: The macro code of "!initxy" without parameter, as it is permanently stored in the TANGO:

```
!mstart 0
_mrm2      ; reply at macro end: @@@@. or EEEE.
a x        ; abort possibly running move in x
a y        ; abort possibly running move in y
_mw3       ; ensure (=wait until) x and y are stopped
!err0      ; clear tango error state
merr       ; clear macro error counter
_mexerr1   ; enable macro exit on error
call       ; calibrate x axis
_mw1       ; wait until x completed
cal2       ; calibrate y axis
_mw-2      ; wait until y completed and safely idle
rm1        ; range measure x axis
_mw1       ; wait until x completed
rm2        ; range measure y axis
_mw2       ; wait until y completed
moc3       ; move x and y to their center positions
_mw-3      ; wait until x and y completed and safely idle
#
```

37.2. Macro Example Code (3x3 Matrix Scan with Trigger)

This example code scans a 3x3 matrix in 1mm steps around a center position. At each position, a trigger signal is forced and the position is returned with a leading index.

Step size, center position and number of images (here 3x3) can be changed in the code to meet custom requirements.

The code can be edited as text and the file named from .txt to .mac.

The file then can be stored in the TANGO by drag&drop of the .mac file in the SwitchBoard command line dialog.

The first line "!mstart ..." defines the macro number 1..8 (here: 1) and the optional macro name for easier identification.

Then the code follows, as a mix of TANGO and macro instructions.

The # character marks the end of the macro code for the TANGO, "msave" stores this macro in the TANGO and "?msave 1" requests the informations about macro 1, which causes a detailed reply to be shown in the SwitchBoard command line.

```
!mstart 1 standalone matrix 3x3 trig
_mjk
!merr           ; reset error counter
_mexev 4        ; pressing joystick F4 aborts the macro
_mexerr 1       ; configure exit on error
_mi 0          ; clear the macro index variable to 0
!trig 0        ; disable the trigger, then configure it below
!trigcount 0   ; optional, might be used to request num of triggers released here
!trigm 102     ; trigger mode = manually forced, active high
!triga x       ; assign the trigger to the x-axis (but is not required for manual trigger)
!trigo 3       ; trigger output = both in default mode (40us grid)
!trigs 2000    ; trigger signal duration = 2000us (2ms), change if required here in 40us steps
!anaout 0 100  ; set the LED to 100% brightness (only if required)
!joy 0         ; disable the joystick
!dim 9 9 9     ; set the xyz-units to mm (if um required to 10 10, then also adapt position
values)
;cal4          ;(this escapes the z-axis (=4), remove the leading ";" if required)
;_mw4         ;(wait until z completed, remove the leading ";" if required)
;moa z 32.1855 ;(move the z-axis to a known focus position, remove the leading ";" if required)
;_mw4         ;(wait until z arrived, remove the leading ";" if required)
cal3          ; calibrate x+y simultaneously (1|2=3)
_mw3         ; wait for end of x+y calibration (1|2=3)
moa 70.318 80.99 ; move to the center of the scan area (enter exact numbers for x and y here!)
_mw3         ; wait until arrived
mor -1 -1     ; go to the first of the 3x3 1mm steps = upper left corner
_mw3         ; wait until arrived at the first position
mor -1       ; go another step behind the x position to start the loop as 3 steps (easier
understanding)
_mw1         ; and wait
!trig 1      ; enable the trigger
_ml         ; start the loop for one line scan (here. 3x +1mm in x)
mor 1       ; move 1mm to the next position in x (1st row)
_mw1         ; and wait for x
!trigger    ; manually force one trigger pulse for the 1st position
_mi 1       ; increment the macro index variable by 1
_mip 1      ; print the macro index variable with a space character, not CR
_mp1        ; allow reply to the PC (for the following ?pos request)
?pos        ; send the position to the application (PC), the index will be leading the reply
_mp0        ; block reply to the PC
_mwt 2      ; wait (ms) if the trigger pulse is long (see !trigs), before moving to the next
position
_mloop 3    ; execute the loop _ml→_mloop 3 times
mor y 1     ; go to the 2nd line, 1mm below
mor x 1     ; move 1 step (1mm) behind the next position
_mw3        ; wait for x+y
_ml         ; start the loop for one line scan (here. 3x -1mm in x)
mor -1     ; move -1mm to the next position in x (2nd row)
_mw1        ; and wait for x
!trigger    ; manually force one trigger pulse for the 1st position
_mi 1       ; increment the macro index variable by 1
_mip 1      ; print the macro index variable with a space character, not CR
_mp1        ; allow reply to the PC
?pos        ; send the position to the application (PC), the index will be leading the reply
_mp0        ; block reply to the PC
```



```
_mwt 2          ; wait (ms) if the trigger pulse is long (see !trigs), before moving to the next
position
_mloop 3        ; execute the loop _ml→_mloop 3 times
mor y 1         ; go to the 3rd line, 1mm below
mor x -1        ; move 1 step (1mm) behind the next position
_mw3           ; wait for x+y
_ml            ; start the loop for one line scan (here. 3x +1mm in x)
mor 1          ; move 1mm to the next position in x (3rd row)
_mw1          ; and wait for x
!trigger       ; manually force one trigger pulse for the 1st position
_mp1          ; allow reply to the PC
_mi 1
_mip 1
?pos          ; send the position to the application (PC)
_mp0          ; block reply to the PC
_mwt 2        ; wait (ms) if the trigger pulse is long (see !trigs), before moving to the next
position
_mloop 3      ; execute the loop _ml→_mloop 3 times

!trig 0       ; disable the trigger before leaving
!joy 2        ; re-enable the joystick
_msend @      ; example: send an information to the PC/application the sequence ended (here for
example a single "@")

#
msave
?msave 1
```

37.3. Macro Example Code (Open Loop Cal Accuracy Test)

This example code calibrates X, Y and Z in an endless loop and prints the motor positions where the cal (E0) switch was detected. The values are in motorsteps.

Macro size: 244 byte (suitable for all macro spaces 1..8)

Macro number: 5 (can be changed, 2 changes required, see .mac code below)

```
!mstart 5 callrnmot test xyz
_mp0
_mexevl        ; exit macro by HDI F1 key
a x           ; stop a possibly running move
a y           ; abort must be sent per axis
a z           ; as a simple "a" also aborts the macro
_mw-7         ; wait until all 3 axes safely (-) stopped
              ; then the cal test loop starts from the current position
_msend learned positions are:
_mp1
?callrnposmot
_mp0

_msend calposmot loop test:
_ml           ; start endless loop (can be ended by HDI F1, see above)
!vrm 10 10 10 ; allow max. 10mm travel range from E0 for randmove (assumed dim 2 or 9)
!randmove 1 1 1 ; randomly move away from E0 switch
_mwt250       ; for 250ms
!randmove 0 0 0 ; then stop
_mw-7        ; and safely wait until stopped and stop is processed (-)
!cal z       ; cal z and wait until calibrated (z first for safety)
_mw-4
!cal x       ; cal x and wait until calibrated
_mw-1
!cal y       ; cal y and wait until calibrated
_mw-2
_mp1         ; print the cal positions
?calposmot
_mp0
_mloop      ; continue loop

#           ; End the macro (returns "mend.") --> the following are just TANGO instructions:
msave      --> save this macro to the TANGO (returns OK...)
?msave 5   --> Request the saved information (size and label) of this macro number
```

37.4. Macro Example Code (Index and Timestamp)

These three short examples show how to use the optional index or timestamp for returned values:

EXAMPLE 1 : Move to positions, print the positions with index

Macro size : 133 byte (suitable for all macro spaces 1..8)

Macro number: 8 (can be changed, 2 changes required, see .mac code below)

```
!mstart 8 move 3 steps and return pos
_mp0
a x          ; stop a possibly running move on x
_mw1        ; wait until x axis has stopped (no space before the "1" to save characters)
_mi0        ; set the index for _mip to 0
;mi 100     ; if we want the index to begin with 100 instead of 0, we can increase +100
_msend moving to positions and returning them with an index:
_m1         ; --- loop begin ---
_mi1        ; increment the macro index variable by 1, so we will get 1,2,3
!mor1       ; move x 1 mm (@ dim 2 or 9) relative (here no x or space to save characters)
_mw-1       ; and safely wait until x has stopped
_mp1        ; allow printing to the PC
_mip1       ; 1=prints the index with [SP], the [CR] will come from the instruction:
?pos x      ; print the axis position (or any other value/command of interest)
_mp0        ; No more printing, as we won't get the @@@ reply in our data
_mloop 3    ; --- loop end --- do this move (1mm and print index + x position) 3 times

#           ; End the macro (returns "mend.") --> the following are just TANGO instructions:
msave      --> save this macro to the TANGO (returns OK...)
?msave 8    --> Request the saved information (size and label) of this macro number
```

→ By executing "!mac 8" we will get a reply like

moving to positions and returning them with an index:

```
1 1.0000
2 2.0000
3 3.0000
```

**EXAMPLE 2 : Read a value 1000 times with a timestamp (macro execution time)**

Macro size : 72 byte (suitable for all macro spaces 1...8)

Macro number: 8 (can be changed, 2 changes required, see .mac code below)

```
!mstart 8 read motor voltage 1000x
_mpl ; allow printing to the PC
_msend motor voltage 1000x:
_ml ; --- loop begin ---
_mip2 ; 2=prints the macro execution time in ms [SP], the [CR] will come from the
instruction:
anain v28 ; print the motor voltage in volts
_mwt 4 ; wait 4ms in order not to overload the transmission (depends on used interface)
_mloop 1000 ; --- loop end --- run this loop 1000 times, or for time: _mloop -1 for 1 minute

# ; End the macro (returns "mend.") --> the following are just TANGO instructions:
msave --> save this macro to the TANGO (returns OK...)
?msave 8 --> Request the saved information (size and label) of this macro number
```

→ By executing "!mac 8" we will get a reply of [time voltage] like

```
motor voltage 1000x:
0 23.88
4 23.83
8 23.82
...
3996 23.96
```

1000 values are returned (_mloop 1000), and the timestamp (0,4,8,...) represents the macro execution time since the macro was started by "!mac 8".

→ If the macro does something ahead of the value return, e.g. move somewhere, calibrate etc., then the timestamp will not start at 0 but at the time that has already passed until the _mip2. Then, _mip 3 can be used to ensure the timestamp starts from 0 and not from a random number:

EXAMPLE 3 : Read a value 1000 times with a timestamp (that starts from 0)

Macro size : 78 byte (suitable for all macro spaces 1...8)

Macro number: 8 (can be changed, 2 changes required, see .mac code below)

```
!mstart 8 read motor voltage 1000x
_mpl ; allow printing to the PC
_msend motor voltage 1000x:
!_mip ; set the time to 0 to ensure our timestamp starts from 0 and not random
_ml ; --- loop begin ---
_mip3 ; 3=prints the timestamp in ms [SP], the [CR] will come from the instruction:
anain v28 ; print the motor voltage in volts
_mwt 4 ; wait 4ms in order not to overload the transmission (depends on used interface)
_mloop 1000 ; --- loop end --- run this loop 1000 times, or for time: _mloop -1 for 1 minute

# ; End the macro (returns "mend.") --> the following are just TANGO instructions:
msave --> save this macro to the TANGO (returns OK...)
?msave 8 --> Request the saved information (size and label) of this macro number
```

→ By executing "!mac 8" we will get a reply of [time voltage], starting at t=0

```
motor voltage 1000x:
0 23.88
4 23.83
8 23.82
...
3996 23.96
```

38. Appendix E – Standalone Applications

Especially 2nd generation TANGOs from firmware 1.78 have many features that allow standalone operation without a PC:

Calibration (CAL)

The TANGO can be configured to perform a calibration of the axes at power-up, by setting "calmode 4" for the corresponding axes. Another option was to use the keyfunc modes to calibrate by HDI function key as described later.

Snapshot Modes

The snapshot settings are stored by save, and the snapshot array position list "snsa" can be stored by "snssave". The snapshot enable state sns can be configured to be 0 (the default) or 1 (enabled) at power-up by the "snspreset" instruction. This enables a full functionality of the snapshot modes without a PC. The snapshot capture and positioning behavior of the snapshot array can be configured to roll-over or stopping at the beginning and the end of the array by the "snswm" instruction (snapshot wrapping mode).

Macros

Up to 8 macros can be stored to the TANGO (different storage sizes available) and one macro can be configured to be executed at power-up by "configmacro".

HDI Key Functions

While the HDI function keys already have default functions assigned, as described for the Joystick in chapter 18 "**Joystick Function Key Assignments**", the HDI function keys (Joystick F1-F4, ERGODRIVE F1-F3) can also be set to a variety of individual functions: Calibrate, Range Measure, Move to Center, Init Sequences, Moving through the Snapshot Array, Filter Wheel Positioning, Remembering a Position, etc. Up to 127 different functions are available, also including Macros or a free definable TANGO instruction sequence of up to 63 characters. Refer to the keyfunc and keyfunctext description and to chapter 19 "**HDI Key Functions (keyfunc)**".

Other Features

The "**block**" instruction can be used to block the command interpreter until axes are idle, keys are pressed, a certain time passed, the snapshot counter reached a certain value and so on. This way a command sequence can be executed by once sending or by the keyfunctext, used by keyfunc mode 70.

The "configencpos" instruction can be used as a preset for the encpos state at power-on. This is especially useful with an external position display, such as the PROFILER SCD-CL, to display the encoder position instead of the motor pos.

39. Appendix F – Center Reference

TANGOs from firmware 1.73 and higher support axes with center reference. Center reference axes are calibrated as usual by the CAL instruction **.

Benefits of a Center Reference

Compared to the usual referencing, where a CAL switch is mounted at the lower end of the axis and mostly also a RM switch at the upper end, a center reference requires only one switch (CAL), which is constantly actuated by a long switching flag on one side of the axis (usually until the axis center, but not necessarily) and not actuated from there towards the other side of the axis.

A CAL instruction will travel to the position where the actuated / not actuated transition of the signal happens (on this it performs a CAL). It is faster than CAL / RM / possibly a move to center plus it saves space and costs for wiring of the RM switches.

Also, by playing with the length of the switching flag, the position where the CAL instruction moves to can be defined by hardware. E.g. to calibrate the axis to a safe position and avoid obstacles or collision.

Cal Learn for higher switch accuracy is also possible on center reference.

Limitations

Using a center reference also means that the axis is not allowed to travel before a CAL is executed (cal is required), because else there is no limit switch that can stop the axes from hitting the ends of the travel range.

** Center reference axes are calibrated as usual by the CAL instruction, but RM instructions will be ignored (not executed, immediately returning).

Option

A center reference with additional limit switches is possible, then the axis could travel before a CAL instruction, but it means having two more switches per axis (=3 in total). Those switches are connected in parallel and go to the RM switch input. The TANGO will find out which (upper/lower) limit is reached by combining the switch state with the center reference signal state (which tells on which side the axis is).

Settings

First of all, the axis direction must be specified. Changing this later on means that many of the following settings must be changed (refer to belated axis direction change info below).

1. axis direction (**axisdir** 0/1)
2. If the axis direction is switched (**axisdir**=1), **swdir** must be set to 1.
3. Center reference actuation scheme: is the signal actuated at lower or upper positions? (set **caldir** to 2/4/6 when at lower and 3/5/7 at upper positions).
4. The upper limit switch must be disabled by **!swact** [axis] 1 0 0 (only if the optional limit switches, refer to Options above, are installed, the RM switch must be enabled as usual)
5. The axis length (total travel range, e.g. 75 or 50 mm) must be specified
6. The distance from the center reference switching position to the axis origin (zero position) must be entered by **posshift** as a positive value.

Belated Axis Direction Change

If, after all settings were made, the axis direction must be changed, the following settings must be re-adjusted:

- **axisdir** 0 <-> 1
- **swdir** 0 <-> 1
- **caldir** 2/4/6 <-> 3/5/7
- **posshift** (only if the reference is not in the exact center it must be mirrored by the axis length (**posshift_new** = axis length - **posshift_old**))
- A position correction must be deleted and newly measured

40. Appendix G – How to Distinguish TANGOs

If a system consists of several TANGOs or several TANGOs are connected to one PC, it might be required to identify and distinguish the TANGOs.

- 1) If connected via USB, the PC assigns and keeps a dedicated COM Port number, by which the TANGO can be selected.
This might be ok when having several TANGOs connected to one PC.
- 2) If connected over Ethernet, each TANGO requires its own address and so it can (must) be identified by it.
- 3) If a system contains several TANGOs and will be used on random PCs, the identification via COM ports does not work, except the port numbers would be re-configured by the user as required. In this case it is required to identify/distinguish the TANGO by reading out informations:
 - Each TANGO has a unique serial number, so it can be identified by reading "**readsn**".
The number contains information about the axes and the controller type.
But: if the controller is replaced, the serial number changes.
 - The TANGO allows storing of an up to 14 characters long, individual information string. It can be written by factory or by the customer to identify the TANGO and its role in the system, e.g. scanner1 xyz.
The instruction is "**iver**".

41. Glossary

TANGO	Motion controller for stepper motors, also called « controller ». For types, refer to Appendix B – TANGO Controller Types (readsn) .
PCI-S,DT-S	TANGO controller type for PCI slots. Firmware only until 1.60. Name is TANGO DT-S if used in TANGO Desktop (TANGO Desktop-S).
PCI-E,DT-E	TANGO controller type for PCI-E slots. Offers greater functionality compared to the PCI-S. Name is TANGO DT-E if used in TANGO Desktop (TANGO Desktop-E).
TANGO-I	A small 2 axis controller usually contained in microscope stages.
TANGO mini	A small 2 axis / 1.0 ampere controller with RS232 connector.
TANGO 3 mini	Same size as the TANGO mini, but with up to 3 axes / 1.25A and much more features, performance and functionality than TANGO mini.
2nd gen. TANGOs	2 nd generation TANGO controller from the 2020s replacing the above mentioned TANGOs. Example : TANGO Desktop HE (2HE / 3HE).
Desktop HE	2 nd generation TANGO Desktop 2HE and TANGO Desktop 3HE controller, replaces TANGO Desktop-E with more options and functionality.
AUX I/O	Optional extension connector for PCI-S and PCI-E based TANGOs and TANGO Desktop. Provides analog and digital I/O, safety and trigger functionality. For TANGO 3 mini please refer to AUX mini.
AUX mini	AUX I/O of the TANGO 3 mini controller.
HDI	Human Device Interface, manual control of the axes, e.g. a Joystick.
LED100	Optional LED illumination unit for microscopes
IO1	Optional I/O connector for DT-E,PCI-E and HE: 24xIN/8xOUT (24/12/5V)
Multi-IO	Optional I/O connector for DT-E,PCI-E and HE: 12xIN/8xOUT (24/12/5V)
IO2	Same as Multi-IO
POS3, xPos	Additional 3-axis module, available with DT-E, PCI-E and Desktop 3HE
Cal	Causes axes to travel towards the lower limit switch (E0). Usually the zero position is also set by this instruction.
Rm	Causes axes to travel towards the upper limit switch (EE). Usually executed directly after cal, it then disables the secvel velocity limitation.
Secvel	Secure velocity which limits the axis travel velocity as long as no cal and rm has been executed. Ment to protect the axes from damage when traveling too fast into (yet unknown) axis hardware limits.
Snapshot	Trigger input functionality, also available with joystick key F2.
Closed Loop	The axis position is controlled according to a measuring system.
Automatic move	Positioning instructions moa,mor,m,moc,mol,moe (also cal,rm) which cause an autostatus reply. Speed and go behave different.
Dimension	The measuring unit (μm , mm, etc.) for positions, as set by dim .



42. Document Revision History

No.	Revision	Date	Changes	Remarks
01	A	27. March 2012	Newly revised and extended document version	Based on TANGO firmware revision 1.57
02	B	16. April 2012	Added instructions: Ecomove, noled, calrequired, joychangeaxis, ctrsm, ctrs, trigo, trigcomp, trigenc, snsi, snsaxis, sns, zwfactor, detext, posclr, maxaxis, trigbwidth, trigbdelay, trigbf, encrefvel, vrm, flash, etspresent, stagesn Added stop and stoppol modes !joy instruction autostatus behavior	Based on TANGO firmware revision 1.57
03	C	03. May 2012	caldir marked as dummy, naming conventions, version instruction	
04	D	18. July 2012	Remarks concerning closed loop behavior and (current) reduction	
05	-	30. July 2012	digin, digout, diginpol, digintyp, digoutpreset	Based on TANGO firmware revision 1.57
06	Prelim E	06. Sept. 2012	Added: Glossary of common terms, Joystick Key Assignment chart Second Trigger Output description Multi I/O instructions edigin, edigout, ediginpol, edigintyp, edigoutpreset Adapted to naming conventions Improved description of HDI	Based on TANGO firmware revision 1.58
07	E	18. Feb. 2013	Added: anamode, trigr, corrst	Based on TANGO firmware revision 1.60
08	F	25. June 2013	Added I/O communication error 77 ?ver instruction "Ver:" to "Vers:" Improved vrm description	
09	G	23. Aug. 2013	Improved go, speed, vel description	Final documentation of firmware 1.60
10	Prelim H	23. Aug. 2013	Extended functionality of "go" and "vel" instructions	Based on TANGO firmware revision 1.60C
11	H	04. Sept. 2013	Added "!mol" and "lockpos"	Based on TANGO firmware revision 1.60C
12	I	16. Oct. 2013	Added "!pa 2"	Based on TANGO firmware revision 1.58
13	Prelim J	02. Dec. 2013	Added multiple manual trigger pulses description	Based on TANGO firmware revision 1.60C
14	Prelim J	06. Dec. 2013	Added scanmode 3	Based on TANGO firmware revision 1.63
15	J	20. Oct. 2014	Corrected "limctr" description Added new ctrstatus option, Added hdimode options for LED100 Added "zwpos", "enctype", "brake", "trigl" instructions Improved descriptions Added snapshot mode "snsm 9" (jump mode) and "snsj" Added calvel, rmvel with one parameter Mentioned "trigenc" encoder trigger position limitations Added sns10 Extended description of "trigs" Revised closed loop descriptions Added "calzeropos" and "tvr" instructions	Final documentation of firmware 1.65



No.	Revision	Date	Changes	Remarks
16	Prelim K	02. April 2015	Corrected snsm 10 description, added liquid dispenser instructions "drop" and "pump", extended "a" description, added LED100 example for adigout	Based on TANGO firmware revision 1.66
17	Prelim K	21. Sept. 2015	Added "clim" instruction, added hdimode bit 8	Based on TANGO firmware revision 1.66
18	Prelim K	21. Oct. 2015	Extended trigr description	Based on firmware 1.66 and 1.60H/1.60S
19	Prelim K	30. Oct. 2015	Extended speed and velfac description	
20	K	10. Nov. 2015	Document released for TANGO Firmware 1.66	Based on TANGO firmware revision 1.66
21	-	01. Dec. 2015	Corrected trigenc description for TTL Added lock and lockstate bits 14, 15	
22	L	22. Dec. 2015	Revised release for TANGO Firmware 1.66	Based on TANGO firmware revision 1.66
23	M	13. Jan. 2016	Improved trigger, "trigs" and 1:1 trigger output mode description	
24		20. Jan. 2016	Improved descriptions of LED100	
25		27. Jan. 2016	Improved and corrected encoder descriptions (encerr = e) etc.	
26	N	16. Feb 2016	Added "trigp", "trigc", "trigi", "iscur", "snsm 11", Improved trigger description, Improved and extended snapshot mode "snsm" description	Final documentation of firmware 1.67
27	O	11. July 2016	Improved descriptions, added "?hdi -1", corrected response description for cal/rm and move instructions.	Based on TANGO firmware revision 1.68
28		20. July 2016	Corrected "refdir" description, Improved descriptions	
29		31. Aug. 2016	Added "edigrly", Added "anamode" setup example Corrected "?anain" motor voltage calculation	
30		06. Sept. 2016	Added "hdimode" bit 9: Swap Joystick Y and Z axes	Based on TANGO firmware revision 1.68
31		18.Oct. 2016	Added "configdisplay", improved "noled" and "accelfunc" descriptions	Based on TANGO firmware revision 1.67
32		20. Dec. 2016	Added adigintyp, adiginfunc Added TANGO 3 mini sections to anain, anaout, anamode, adigin, adigout, brake, stoppol and drop Added new Error Numbers Improved descriptions	Based on TANGO 3 mini firmware 1.68
33		01. March 2017	Added "ctrd" parameter -1, Improved ctrd+ctrc description	Based on TANGO firmware 1.68
34		29. March 2017	Improved "scanmode" and "modulomode" description	
35	P	15. May 2017	Removed formatting error (20 was shown instead of the parameters throughout the document) Improved trigger description, added TANGO 3 mini	Based on TANGO firmware 1.68
36	Q	12. Jan. 2018	Improved I/O description and influence of the brake function Improved "anaout", "keymode" and "keyspeed" descriptions	



No.	Revision	Date	Changes	Remarks
37		09. March 2018	Added hdimode bit 10 description Added ctrdiff 1 option Changed Firmware from 1.68 to 1.69 Extended anamode description	Based on TANGO firmware 1.69
38	R	26. March 2018	Added decription of cal, rm behavior and nosetlimit to the llim instruction	
39		25. May 2018	Moved autostatus description from chapter "Controller States and Error Messages" to "Operating Modes"	
40		01. Aug. 2018	Added "calst" instruction Improved introduction, improved descriptions of closed loop and several instructions	Based on TANGO firmware 1.70
41	S	12. Sept. 2018	Added "brakepos" instruction	Based on TANGO firmware 1.70
42	T	22. Nov. 2018	-	Release for TANGO firmware 1.70
43		09. May 2019	Updated "ctrdiff" documentation Added "?enc 1" option	Based on TANGO firmware 1.71
44		22. May 2019	Added "encsync" instruction	
45	U	04. June 2019	Improved "lim" and "sevel" description	Release for TANGO firmware 1.71
46		25. June 2019	Improved "usteps" description	
47		18. July 2019	Improved description of the second trigger output and the snsj instruction	Based on TANGO firmware 1.72
48		28. Aug. 2019	Extended and updated "encpos" description Added "configencpos" description Added "calmode" 3, 4, 5 description Extended and updated "uptime" description	Based on TANGO firmware 1.72
49	V	06. Nov. 2019	Added "!pa 3"	Final documentation of firmware 1.72
		09. March 2020	"adigintyp" and "adiginfunc" changed from AUX mini to TANGO 3 mini	
50		13. March 2020	Improved description of "go"	
51		30. Oct. 2020	Added "encref" parameter 3	Based on TANGO firmware 1.73
52		10. June 2021	Improved "statusaxis" description, added "sta" description	Based on TANGO firmware 1.73
53		01. July 2021	Added "autopreset" and "snspreset"	Based on TANGO firmware 1.73
54		12. July 2021	Extended descriptions	Based on TANGO firmware 1.73
55		16. July 2021	Added Desktop HE instructions "cmderr", "cmdlist", "moe", "limmode", "vusb", "configvusb", "configcanres", "adigoutpreset", "vbrake", "brakedelay", "stopl" Added Desktop HE descriptions to "vbus", "configvbus", "adigin", "adigintyp", "adiginfunc", "brake", "enctype" Extended and improved descriptions	Based on TANGO Desktop HE
56		16. July 2021	Added "calposmot" description, "anamode 5" description	Based on TANGO firmware 1.73
57		19. July 2021	Added absolute encoder description to "encamp" Added "encres", "encform", "abspos", "calabspos", "posshift"	Based on TANGO Desktop HE
58	W	21. July 2021	Added "trigsns" instruction Improved "zwpos" description Corrected errors in the entire document	Final documentation of firmware 1.73 and TANGO Desktop HE



No.	Revision	Date	Changes	Remarks
59		29. July 2021	Improved "hdi" description	
60		03. Sept. 2021	Added Nikon FL-Turret section and instructions	Based on TANGO DT-E, Desktop HE, TM3 Firmware 1.74
61		07. Sept. 2021	Updated "iver" documentation	Based on TANGO firmware 1.74
62		09. Sept. 2021	Added configwsz, configfilter, rxtimeout, ipaddr, netmask, gateway, macaddr, disconnect Updated the description of CAL and its instructions concerning cal on encoder reference mark	Based on TANGO firmware 1.74 and Desktop HE
63		23. Sept. 2021	Improved modulomode, gear and pitch descriptions, added faxis, raxis	Based on TANGO firmware 1.74
64		24. Sept. 2021	Added keepm instruction	Based on TANGO firmware 1.74
65		18. Oct. 2021	Extended caldir description	Based on TANGO firmware 1.74
66		15. Nov. 2021	Improved autostatus 4 description	
67		23. Nov 2021	Added Filter Wheel, Revolver and Nikon FL-Turret instructions	Based on TANGO firmware 1.74
68		25. Nov 2021	changed "configfilter" to "configturret"	Based on TANGO firmware 1.74
69		29. Nov. 2021	Added "?trigs -1" option	Based on TANGO firmware 1.74
70	X	21. Dec. 2021	Added "blsmooth"	Based on Desktop HE firmware 1.74
71		04. Jan. 2022	Updated Appendix A (anain)	Based on TANGO firmware 1.74
72		08 Jan. 2022	Updated Nikon FL-Turret instructions "tur" and "mpower"	Based on TANGO firmware 1.74
73		14. June 2022	Addeed "sp" instruction	Based on TANGO firmware 1.75
74	Y	22. June 2022	-	Final documentation of firmware 1.75
75		24. June 2022	Improved explanation of limit instructions	
76		27. June 2022	Added Appendix B (TANGO types of readsn), corrected dim 10 to μm	
77		19. July 2022	Added Macro Instructions	Based on TANGO firmware 1.76
78		27. July 2022	Changed table headline colors of the brief instruction description	
79		29. July 2022	Improved TVR description	Based on TANGO firmware 1.76
80		31. Aug. 2022	Changed filter wheel and revolver decription of raxis, faxis, rcount and fcount	Based on TANGO firmware 1.76
81		01. Sept. 2022	Added Piezo-Z instructions	Based on TANGO firmware 1.76
82		29. Nov. 2022	Improved description of joywindow	
83	Z	21. Dec. 2022	-	Final documentation of firmware 1.76
84		06. Jan. 2023	Improved description of encamp	
85		08. Feb. 2023	Corrected description of vusb and configvusb	Based on TANGO firmware 1.76
86		16. Feb. 2023	Improved description of trigcomp	
87		01. March 2023	Added "limmove" and "randmove"	
88		08. March 2023	Added "configextpwr" for PCIE21	Based on TANGO firmware 1.77
89		06. April 2023	Updated "Availability" information	
90		24. April 2023	Corrected temp instruction description for 2 nd gen. TANGOs	
91		03. May 2023	Added snssave and extended snapshot documentation for 2 nd gen. TANGOs Added paswitchoff for 2 nd gen. TANGOs	Based on TANGO firmware 1.77
92		23. May 2023	Improved description of "?det"	
93		24. May 2023	Improved Snapshot description	



No.	Revision	Date	Changes	Remarks
94		25. May 2023	Added information of positioning in dim 3 with modulomode=0	
95		31. May 2023	Added "ljoy -1" description	Based on TANGO firmware 1.77
96		15. June 2023	Added "precmode" and "precdist"	Based on TANGO firmware 1.77
97		16. June 2023	Added "hdimode" bit 11 (quickstop)	Based on TANGO firmware 1.77
98		21. June 2023	Improved ?randmove and ?limmove description	Based on TANGO firmware 1.77
99		12. July 2023	Added "block" instruction	Based on TANGO firmware 1.77
100		13. July 2023	Changed caltimeout max. to 600s	Based on TANGO firmware 1.77
101		21. July 2023	Added "create" instruction	Based on TANGO firmware 1.77
102		24. July 2023	Corrected and updated joyvel and keyspeed instructions	Based on TANGO firmware 1.77
103		25. July 2023	Corrected document errors	
104		08. Aug. 2023	Added the "Setup for Rotary Axes" chapter	
105		09. Aug. 2023	Added "calresult"	Based on TANGO firmware 1.77
106		16. Aug. 2023	Corrected document errors	
107	ZA	17. Aug. 2023	Better explanation of round limits "clim" Better explanation of "precdist" Added information about cal on reference mark only concerning a forced rotation direction by modulomodes 2 and 3 as an option (for 2 nd gen TANGOs with firmware 1.77 and higher)	Final documentation of firmware 1.77
108		23. Aug. 2023	Added hdimode bit 12 (POS3 Joyst.)	Based on TANGO firmware 1.78
109		19. Sept. 2023	Added "dissect" and extended "create" instruction	Based on TANGO firmware 1.78
110		22. Sept. 2023	Added "brakemode"	Based on TANGO firmware 1.78
111		28. Sept. 2023	Added "snswm"	Based on TANGO firmware 1.78
112		06. Oct. 2023	Added "keyfunc", "keyfunctext", a chapter describing the function and a chapter for standalone applications	Based on TANGO firmware 1.78
113		24. Oct. 2023	Added "keyfunclock"	Based on TANGO firmware 1.78
114		13. Nov. 2023	Added "nflctrver" for Nikon FL-Turret	Based on TANGO firmware 1.78
115		05. Dec. 2023	Added "lim" save and restore option	Based on TANGO firmware 1.78
116	ZB	06. Jan. 2024	-	Final documentation of firmware 1.78
117	ZC	05. Mar. 2024	Repaired defect words and links	Based on TANGO firmware 1.78
118		13. Mar. 2024	Added two new keyfunc functions 64 and 127	Based on TANGO firmware 1.79
119		14. Mar. 2024	Added "Appendix D – Center Reference"	
120	ZD	15. Mar. 2024	Updated "trigenc" description, revised Appendix section	Release
121		25. Mar. 2024	Corrected !pa 3 description: XY only	
122		11. April 2024	Improved description of anamode	Based on TANGO firmware 1.79
123		16. April 2023	Added max. save executions info	
124		25. April 2024	Added snsamp and !pa 4 for 2 nd gen. TANGOs	Based on TANGO firmware 1.79
125		18. July 2024	Added the external filter wheel documentation for MW filter wheels with integrated controller	
126		24. July 2024	Added ?etstemp	
127		30. July 2024	Added joytoaxis	Based on TANGO firmware 1.79
128		06. Aug. 2024	Added configmathe	



No.	Revision	Date	Changes	Remarks
129		13. Aug. 2024	Added "Joystick Options Explained"	Based on 2 nd gen. TANGO firmware 1.79
		13. Aug. 2024	Added Appendix G – How to Distinguish TANGOs	Based on TANGO firmware 1.74
130	ZE	14. Aug. 2024	-	Release
131		28. Aug. 2024	Added 3 short macro examples for explaining index and timestamp	Based on 2 nd gen. TANGO firmware 1.80
132		11. Sept. 2024	Improved "KeyFunc Table of available Functions"	
133		12. Sept. 2024	Added calmode 5 information about restoring user limits (!lim + save)	Based on 1 nd gen. TANGO firmware 1.79 Based on 2 nd gen. TANGO firmware 1.80
134		19. Sept. 2024	Improved trigm description	
135		23. Sept. 2024	Added encsearchdir	Based on TANGO firmware 1.80
136		09. Oct. 2024	Appendix A – anain options of different TANGOs re-arranged for better comparison of the TANGOs	
137		20. Nov 2024	Added "filcorr" and "filsave"	Based on 2 nd gen. TANGO firmware 1.80
138		25. Nov 2024	Added "finit", "rinit and "init" information about applying position correction	Based on 2 nd gen. TANGO firmware 1.80
139	ZF	16. Dec. 2024	-	Release